

Panasonic[®]

PDF Eraser Free

Operating Instructions

DECT Portable Station

Model No. **KX-TCA275**

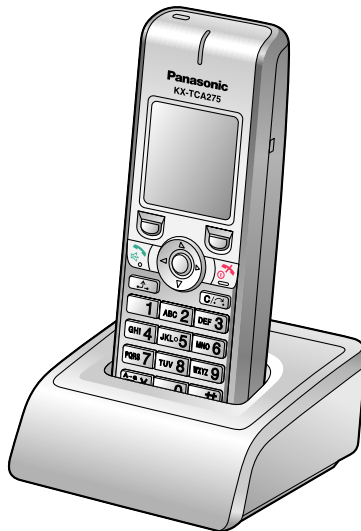

Thank you for purchasing a Panasonic DECT Portable Station.

Please read this manual carefully before using this product and save this manual for future use.

Please use only the battery provided and charge the battery for about 5.5 hours before using the handset for the first time.

Note:

In this manual, the suffix of each model number is omitted unless necessary.

Table of Contents

PDF Eraser Free

Before Initial Use	4
Accessories (included)	4
Installation	5
Battery Installation	5
Charger Connection	5
Charging the Battery	6
Charger Wall Mounting	6
Attaching the Belt Clip	7
Attaching the Phone Strap	8
Setting the Password	8
Before Operating the Handset	9
Location of Controls	9
Key Lock	11
Meeting Mode	11
Power Save Mode	11
Selecting the Display Language	12
Editing the Standby Display Name	13
Editing the Names of the Flexible Keys	14
Adjusting the Ringer Volume	15
Adjusting the Ringer Volume or Turning the Ringer off while	
Ringing	15
Changing the Vibrate Setting	16
Adjusting the Receiver/Speaker/Headset Volume	16
Display	17
Soft Keys	18
Operation Outline	20
Function Menus	21
Function Keys	22
Flexible Keys	24
Operation	25
Making Calls	25
Searching for an item stored in the Phonebook	29
Receiving Calls	33
Caller ID	34
During a Conversation	35
Useful Features	37
Making Use of the Voice Mail Service	42
Using the Handset Phonebook	44
Handset Phonebook	44
Private Ring	44
Storing an Item in the Handset Phonebook	45
Storing a New Item	45
Editing a Stored Item	46
Storing an Item Using the Predialling	47
Storing an Item Using the Outgoing Call Log	48

PDF ELI5ET FREE





Storing an Item Using the Incoming Call Log	49
Storing an Item Using the PBX System Phonebook	50
Storing an Item Using the PBX Extension Phonebook	51
Editing Category Names	52
Assigning Hot Keys	53
Selecting the Type of Hot Key Dialling	54
Entering Characters	55
Character Mode Table	56
Locking the Handset Phonebook	57
Locking the Handset Phonebook	57
Unlocking the Handset Phonebook	57
Unlocking the Handset Phonebook Temporarily	57
Deleting Stored Items	58
Deleting Stored Items in Handset Phonebook/Hot Key Dial/Outgoing Call Log/Incoming Call Log	58
Handset Phonebook	58
Hot Key Dial	59
Outgoing Call Log	60
Incoming Call Log	60
Configuring Handset Settings	61
Changing the Initial Settings	61
Handset Setting Menu Layout	62
Memo Alarm Setting	72
Troubleshooting and Error Messages	75
Troubleshooting	75
Error Messages	77
Important Information	78
Battery Information	78
Important Safety Instructions	80
For Your Safety	80
For Best Performance	83
Additional Information	87

Before Initial Use

Please read "Important Information" on page 78 before using. Read and understand all instructions. For System Requirements, see page 86.

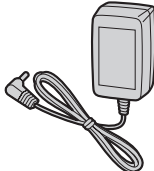
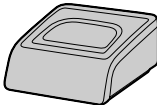
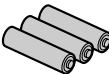
PDF Eraser Free

Accessories (included)

<p>AC adaptor: 1</p> 	<p>[Part No.] For KX-TCA275CE users: PQLV219CE For KX-TCA275UK users: PQLV219E For KX-TCA275AL users: PQLV209AL</p>	
<p>Charger: 1</p> 	<p>Battery: 3</p>  <p>[Part No.] HHR-4EPT</p>	<p>Belt Clip: 1</p> 
<p>Belt Clip Holder: 1</p> 	<p>Battery Cover: 1</p> 	

Installation

Battery Installation

Insert the batteries, and close the cover as indicated below.

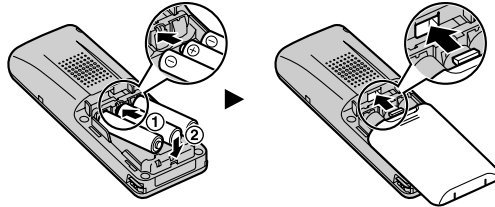

Charger Connection

Connect the AC adaptor to the charger.

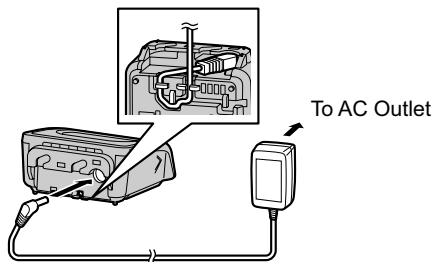

- The AC adaptor should be connected to a vertically oriented or floor-mounted AC outlet. Do not connect the AC adaptor to a ceiling-mounted AC outlet, as the weight of the adaptor may cause it to become disconnected.
- Fasten the AC adaptor cord to the cord holder.
- Use only the included Panasonic AC adaptor.
 - For KX-TCA275CE users: Part No. PQLV219CE
 - For KX-TCA275UK users: Part No. PQLV219E
 - For KX-TCA275AL users: Part No. PQLV209AL

WARNING

- To reduce the risk of fire or electric shock, do not overload AC outlets and extension cords.
- Do not bundle the charger's AC adaptor cord with the power cords of machines located nearby.
- Completely insert the AC adaptor/power plug into the AC outlet. Failure to do so may cause electric shock and/or excessive heat resulting in a fire.

Before Initial Use

Charging the Battery

At the time of shipment, the battery is not charged. **Please charge the battery for about 5.5 hours before using the handset for the first time.**

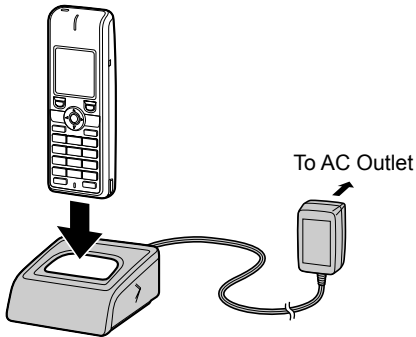

- When the battery has been completely charged, the charge indicator will change from red to green. For more information, see "Battery Information" on page 78.
- It is normal for the handset and charger to feel warm while the battery is charging.
- Keep devices sensitive to magnetic fields away from the charger.
- Use only the included charger.

Charger Wall Mounting

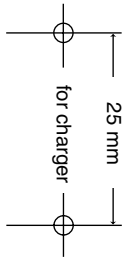

1. Install the two screws in the wall, spacing them 25 mm apart.

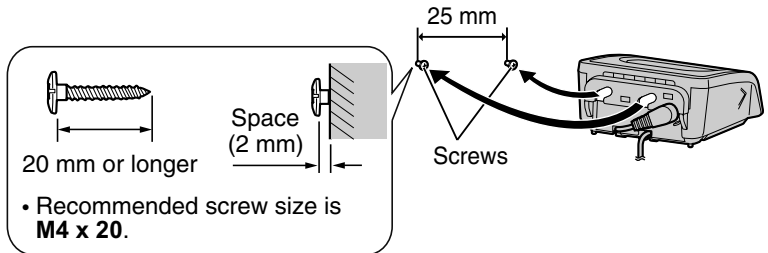

2. Mount the charger securely on the wall.

- When you print out this page for wall mounting purposes, the printed output distance may deviate slightly from the indicated measurement. In this case, use the measurement indicated. When mounting the charger, ensure that the correct screws are used for the type of wall.
- Make sure that the wall that the charger will be attached to is strong enough to support the total weight of the handset and charger (approx. 180 g). If not, it is necessary for the wall to be reinforced.
- When this product is no longer in use, make sure to detach it from the wall.
- When inserting screws, avoid pipes and electrical cables, etc. that may be present/ buried.
- The screw heads should not be flush to the wall.
- Certain types of wall may require plugs to be anchored in the wall before the screws are inserted.

Attaching the Belt Clip

You can attach the handset to your belt by following the steps below.

[To attach]

- 1 Insert the clip into the designated notches in the handset.

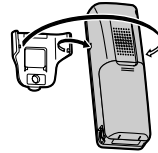

- 2 Slide the clip into the holder until it clicks.



[To remove]

- 1 Make sure to turn the handset 180° when you take it off.

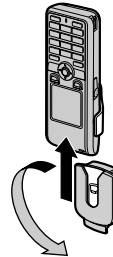

- 2 Remove the belt clip.

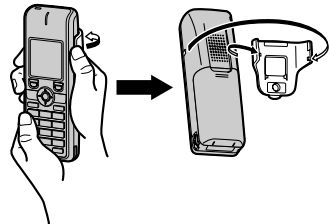

Before Initial Use

Attaching the Phone Strap

Open the battery cover, run the strap through the strap hole, and then loop it around the hook.

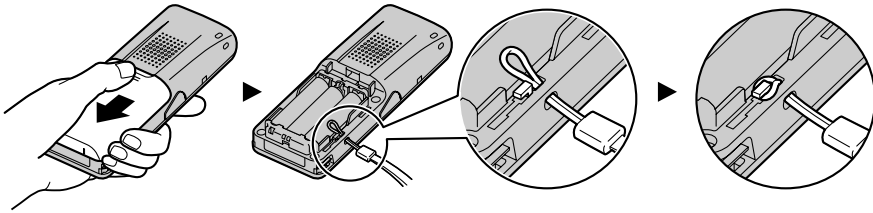

Setting the Password

The handset password is not set by default. You must register a handset password (4 digits) before use.

You cannot use the following features without setting a password:

- Phonebook lock (See page 57.)
- "Manual&Password" or "Auto&Password" for Key lock type (See "Key Option" on page 66.)
- Reset Handset (See "Other Option" on page 71.)

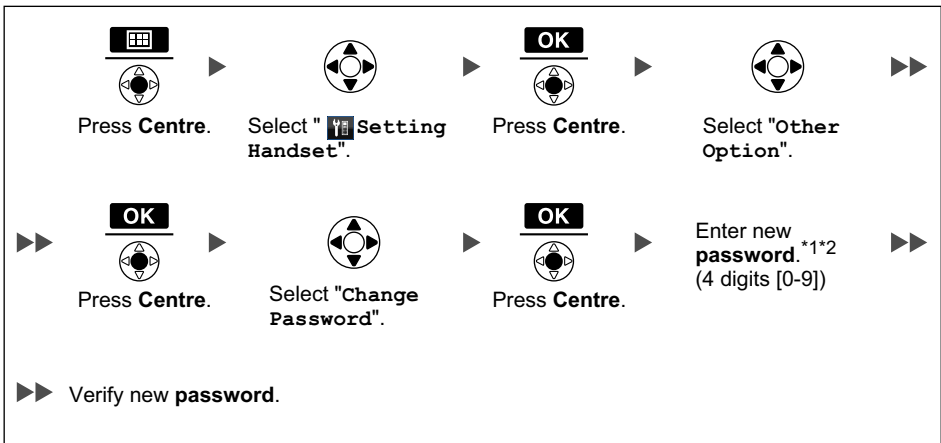

*1 To avoid unauthorised access to this product:

- Set a password that is random and cannot be easily guessed.
- Change the password regularly.

*2 Make a note of the password so that you will not forget it.

Location of Controls

The headset is an optional accessory.

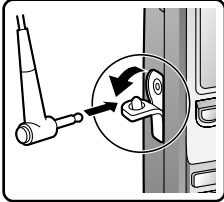

Open the cover.

[Back View]

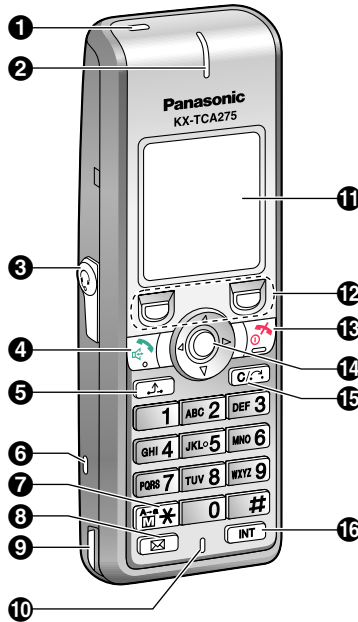
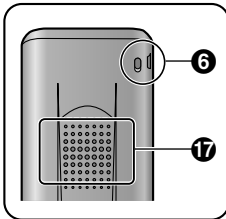

18 Press **POWER** for more than 2 seconds.
[Power On]
 Standby mode
[Power Off]
 Blank display

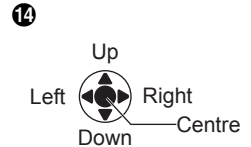

You can use the Navigator Key to move the cursor in the desired direction. Pressing down the centre of the key confirms a selection.

1 Ringer/Charger Indicator

2 Receiver

3 Headset Jack

4 TALK/SP-PHONE (Speakerphone)

Used to make or answer calls, or toggle between the Receiver/Hands-free*1 mode during a conversation.

5 HOLD

Used to place a call on Hold.

6 Strap holes

Used to attach phone straps and similar items.

7 Meeting Mode

Used to turn Meeting Mode on or off when pressed for more than 2 seconds in standby mode.

For more information, see "Meeting Mode" on page 11.

Before Operating the Handset

8 Message

Used to leave a message waiting indication, or to call back the party who left a message waiting indication.

9 Charge Contact

10 Microphone

11 Display

Refer to "Display" on page 17.

12 Left/Right Soft Key

Used to select the function displayed directly above each key. Functions are displayed based on the current context.

Also used as a Function Key, Flexible Key, or Hot Key when they are assigned. To edit the soft keys, see "Key Option" on page 66.

13 POWER/CANCEL

Used to end calls, exit the Phonebook or Function mode, or turn the handset on or off.

14 Navigator Key

Used to adjust the ringer/receiver volume, or move the cursor to select an item. Pressing down the centre of the key confirms a selection.

15 TRANSFER/CLEAR

Used to transfer a call to another party, or to clear digits or characters.

16 INTERCOM















Used to make or answer intercom calls.

17 Speaker

- *1 You can talk with the other party through the speaker using Hands-free mode. During a conversation using a headset, Hands-free mode does not work.

Key Lock

You can lock all keys other than the Navigator Key while the handset is in standby mode. One of 4 key lock types can be selected. (See "Key Option" on page 66.)

 	[Display Icon]				
Press Centre for more than 2 seconds to lock/unlock.	<table><tr><td style="text-align: center;">Unlocked</td><td style="text-align: center;">Locked</td></tr><tr><td style="text-align: center;"> </td><td style="text-align: center;"> </td></tr></table>	Unlocked	Locked	 	 
Unlocked	Locked				
 	 				

- If you select "**Manual&Password**" or "**Auto&Password**" for Key lock type, you need to enter the password for unlocking.
- If no password has been set, you cannot select "**Manual&Password**" or "**Auto&Password**" for Key lock type. To set the password, see "Setting the Password" on page 8.

Meeting Mode

Meeting Mode turns off the ringer and sets the handset to vibrate when calls are received. This can be useful in situations where you do not want to be disturbed, such as during a meeting.

When Meeting Mode is active, the microphone's sensitivity is increased, and the following features are turned off automatically, regardless of their settings.

- Ringer Volume
 - Ring On Charger
 - Auto Answer
 - Key Tone
 - Range Alarm
 - Low Battery Alarm
- If you set the handset on the charger during Meeting Mode, the handset will not vibrate.*1
- *1 Please note that if you set the handset on the charger while receiving an incoming call, vibration will stop. Once the vibration stops, the handset will not vibrate again for that call, even if the handset is lifted up again. (If Quick Answer is set, lifting up the handset will answer the call.)

Power Save Mode

Power Save Mode turns off the ringer, LCD backlight, key backlight, or vibration automatically after a set number of seconds has passed while receiving calls. To adjust power save mode settings, see "Incoming Option" on page 64.

Selecting the Display Language

You can select the language displayed on your handset.

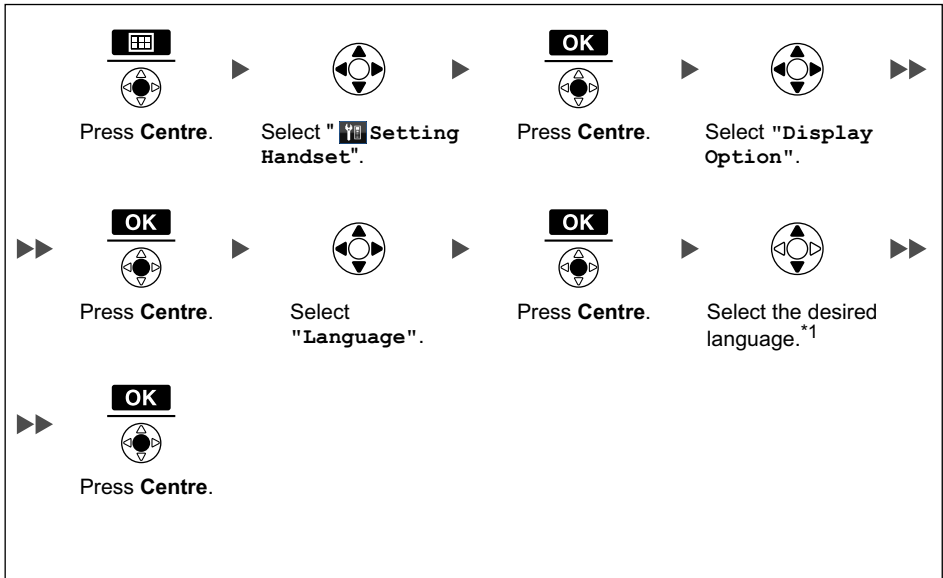

*1 You can select "Auto" or one of the 16 languages below:

English, Deutsch, Español, FRANÇAIS, Italiano, Dansk, Nederlands, Svenska, Suomi, ΕΛΛΗΝΙΚΑ, Magyar, Português, Polski, slovensky, čeština, Hrvatski.

- When set to "Auto", the language settings of the PBX will be used.
- The display language of both the handset and PBX can be selected, and both should be set to the same language. For more information, refer to the user documentation for your PBX.

Editing the Standby Display Name

You can edit the name displayed when the handset is in standby mode.

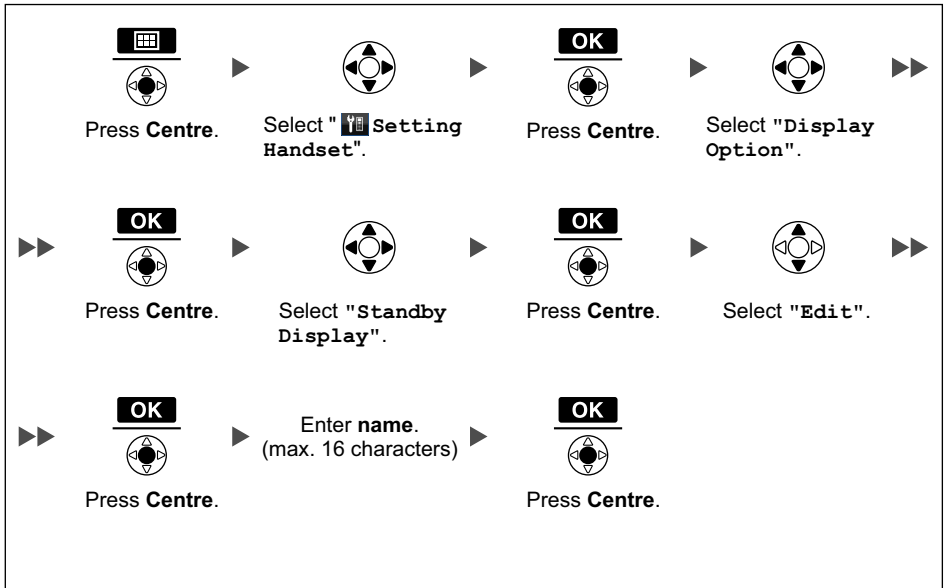

- To enter characters, see page 55.

Editing the Names of the Flexible Keys

You can edit a name for each Flexible Key of the handset.

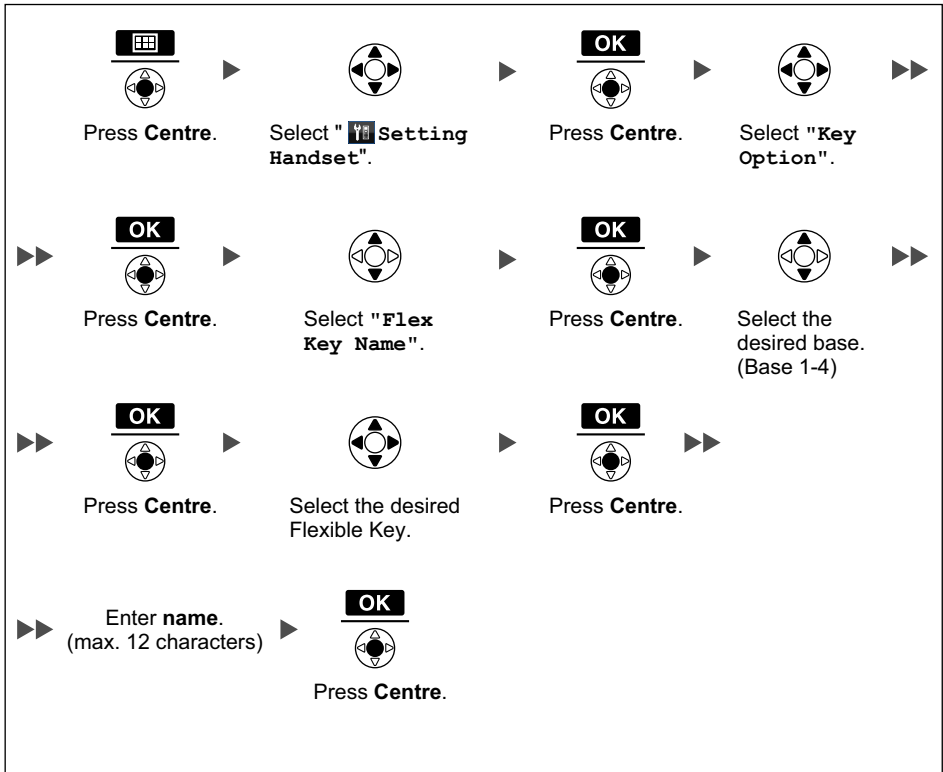

- To enter characters, see page 55.

Adjusting the Ringer Volume

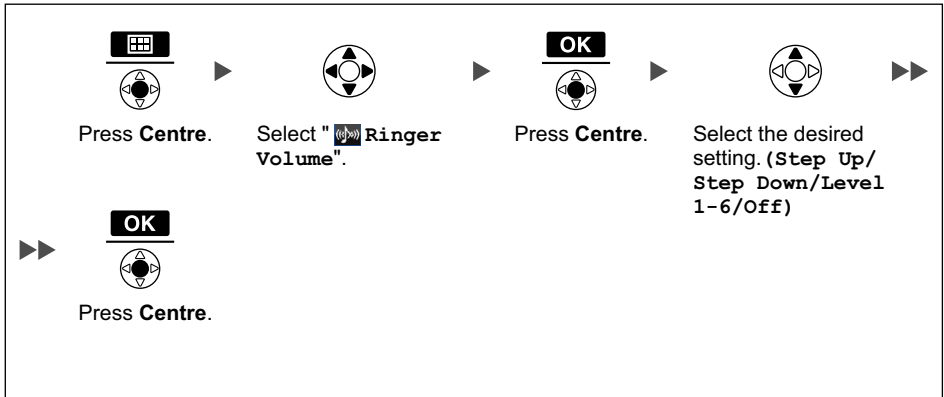

- To set the ringer pattern, see "Incoming Option" on page 64.

Adjusting the Ringer Volume or Turning the Ringer off while Ringing

While receiving a call

[To adjust the ringer volume]



Press **Up** or **Down** to adjust the volume.*1

[To turn the ringer off]



Press **Centre**.

OR



Press **CANCEL**.

*1 The adjusted volume level will also be used for subsequent calls.

- If you attach the headset while receiving an incoming call, the ring from the handset does not switch to the headset. If you attach the headset before receiving an incoming call, and headset tone is set to "On", a tone will be heard from the headset. If Vibrate is set to on, the handset will vibrate whether a headset is attached or not.

Changing the Vibrate Setting

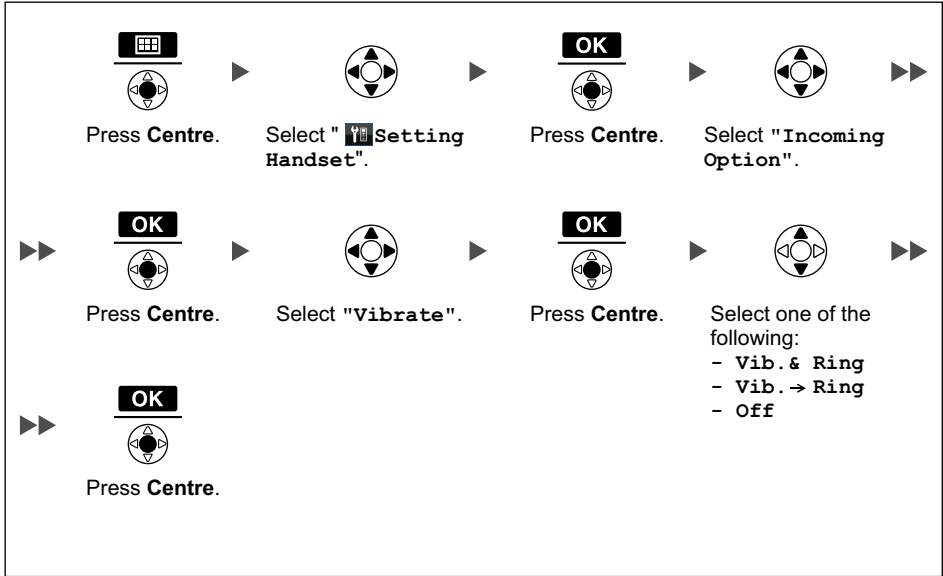

- To set Vibrate only, without ringing, select "**vib. & Ring**" and set the Ringer Volume to off, or turn Meeting Mode on. (See page 11, 15.)

Adjusting the Receiver/Speaker/Headset Volume

During a conversation



Press **Up** or **Down** to adjust the volume.

(Receiver Volume—Level 1-5, Speaker Volume—Level 1-6, Headset Volume—Level 1-5)

Display



1 Pictograph

	Within range of a Cell Station (CS)	Battery Indicator ^{*1} Full Low Needs to be charged.
	Out of range	
	Intercom Indicator	
	Off-hook Status	
	Message Waiting	
	Phonebook	
	Navigation Key Guidance	

2 Handset Status Information

A. Ans Auto Answer	Ringer Volume Off (See page 15.)
Call Forwarding (See page 37.)	Meeting Mode (See page 11.)
Do Not Disturb (See page 37.)	Vibrate (See page 16.)

3 Date and Time Display

4 Soft Keys

For more information, see page 18.

5 Extension Number and Name

To edit the standby display name, see page 13.























6 Incoming Call Log Status

*1 See "Battery Information" on page 78.









- Example images of the display in this manual are samples only, and the actual screen on your phone may vary in colour and/or appearance.

Soft Keys

Icons and information shown on the display will vary depending on the context. To select an item shown on the display, press the corresponding soft key.

	Opens the Phonebook. Pressing this key for more than 2 seconds locks the Phonebook.		Inserts a dialling pause.
	Displayed when in Phonebook Lock. Pressing this key and then entering the password (default: not registered), unlocks the Phonebook temporarily. Pressing for more than 2 seconds, then entering the password (default: not registered), unlocks the Phonebook. If no password has been set, you cannot lock the Phonebook.		Clears digits or characters.
	Stores a new item in the Phonebook.		Turns the microphone mute feature on or off during a conversation. Flashes when Mic Mute is on.
	Opens the PBX System Phonebook.		Turns the ringer off.
	Opens the PBX Extension Phonebook.		Opens the main menu. Pressing this key for more than 2 seconds locks all keys.
	Displays the caller information stored in the Handset Phonebook while receiving a call.		Returns to the previous display.
	Displays the caller information stored in the system while receiving a call.		Opens the list menu (edit/delete in the Phonebook, etc.).
	Establishes a multiple-party conversation (Conference).		Confirms the entry.
	Searches for an item in the Phonebook alphabetically.		Displayed when in Key Lock mode. Pressing this key for more than 2 seconds unlocks the keys.
	Displayed when in Alphabetic character entry mode. Pressing this key switches to Numeric character entry mode.		Advances to the next display.
	Displayed when in Numeric character entry mode. Pressing this key switches to Greek character entry mode.		Used to clear the Memo Alarm display setting, or enter an "x" when storing the Line Access CD.

Before Operating the Handset

ABΓ	Displayed when in Greek character entry mode. Pressing this key switches to Special character (Extended 1) entry mode.	RECALL	Disconnects the current call and allows you to make another call without hanging up.
Αάα	Displayed when in Special character (Extended 1) entry mode. Pressing this key switches to Special character (Extended 2) character entry mode.	F	Used to register the handset with the PBX simply.
Σςς	Displayed when in Special character (Extended 2) entry mode. Pressing this key switches to Alphabetic character entry mode.		Displayed when it is possible to use an arrow key to make a selection.
	Displays the Outgoing Call Log.		Displayed when the corresponding soft key has no function.
REDIAL	Displays the last dialled number.		
	Opens the Incoming Call Log.		Used for System/Personal Speed Dialling.
→GRP	Opens the Incoming Call Log Group.		Used to set/clear the Auto Answer mode.
	Used to select an item when in setting mode.	PBX	Used to enter PBX Personal Programming mode.
AM/PM	Used to select AM or PM when setting the Memo Alarm feature.		Used to set Call Forwarding and Do Not Disturb.

Operation Outline

Handset functions are accessed through the display menu and selected with the Navigator Key and soft keys. The guidance display is shown in standby mode for easy operation.

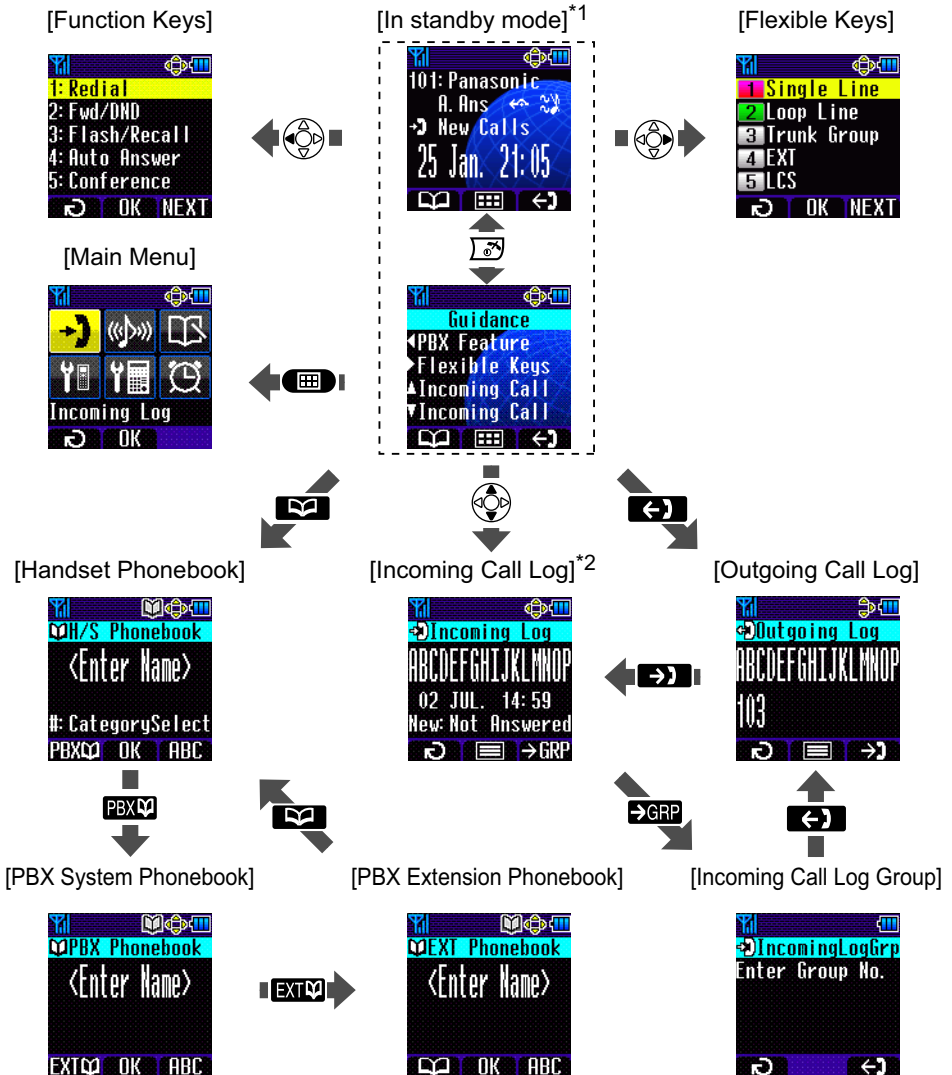

*1 You can select whether the guidance display is shown or not. (See "Display Option" on page 68.)

*2 Pressing the Navigator Key ◀ displays the phone number.

- The selected item changes colour.

- To enter characters, see page 55. To search for an item stored in the Phonebook, see page 29.

PDF Eraser Free

Function Menus

Press the Navigator Key to display the main and sub menus.

Main Menu—While in Standby Mode



Incoming Log:
Enters the Incoming Call Log.



Ringer Volume:
Accesses the "Ringer Volume" setting.



New Phonebook:
Stores a new item in the Phonebook.



Setting Handset:
Accesses the "Setting Handset" settings.



PBX Program:
Enters PBX Personal Programming mode.
For PBX Personal Programming, refer to the user documentation for your PBX. Press  to exit from PBX Personal Programming mode.



Memo Alarm:
Accesses the "Memo Alarm" settings.

Sub Menu—While Off-hook/During a Conversation



Phonebook:
Opens the Phonebook.



New Phonebook:
Stores a new item in the Phonebook.



Outgoing Log:
Enters the Outgoing Call Log.



Incoming Log:
Enters the Incoming Call Log.



Mute:
Turns the microphone mute feature on or off during a conversation.

Function Keys

Handset functions can be activated through the display key list. Press the Navigator Key ◀ to display the function key list.



1: Redial

Redials the last dialed number.

2: Fwd/DND

Displays and/or sets Call Forwarding and Do Not Disturb.

3: Flash/Recall

Disconnects the current call and allows you to make another call without hanging up.

4: Auto Answer

Answers an incoming call automatically in hands-free mode. "A. Ans" is displayed in standby mode.

5: Conference

Establishes a multiple-party conversation.

6: Pause

Inserts a dialling pause.

7: H/S Phonebook

Makes a call using the Handset Phonebook.

8: PBX Phonebook

Makes a call using the PBX System Phonebook.

9: EXT Phonebook

Makes a call using the PBX Extension Phonebook.

0: PBX Program

Enters PBX Personal Programming mode. Press  to exit PBX Personal Programming mode.

***: Incoming Log**







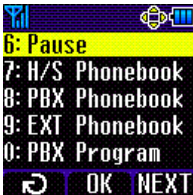

















Makes a call using the Incoming Call Log.

#: Outgoing Log

Makes a call using the Outgoing Call Log.



- For PBX Personal Programming, refer to the user documentation for your PBX.

Shortcut Combinations			
 	Redial	 	H/S Phonebook
 	Fwd/DND	 	PBX Phonebook
 	Flash/Recall	 	EXT Phonebook
 	Auto Answer	 	PBX Program
 	Conference	 	Incoming Log
 	Pause	 	Outgoing Log

- For operation, see page 25.
- To edit the function key list, see "Key Option" on page 66.

Flexible Keys

A Flexible Key can be used either to seize a line in order to make or receive an outside call, or used as a function key. Press the Navigator Key ► to display the Flexible Key list. Here you can access the 12 Flexible Keys. The colour of each key number indicates line status similarly to the LED indicators on a Proprietary Telephone.

[Example]

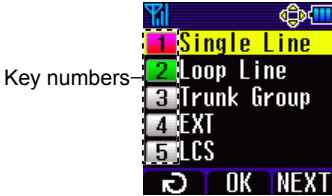

Understanding the Flexible Keys*1

Colour of key numbers		Line status
Green	on	You are currently using this line.
	flashing rapidly	You have an incoming call on this line. (An outside call is coming in on a single extension.)
	flashing slowly	You have a call on hold on this line.
Red	on	This line is in use by someone else.
	flashing rapidly	You have an incoming call on this line. (An outside call is coming in on multiple extensions simultaneously.)
	flashing slowly	Someone has a call on hold on this line.
No colour		This line is idle.

*1 The meanings of these colours of key numbers vary depending on the status of the outside line.

- To select a key, press its key number, or press the Navigator Key ▲ or ▼ to select the desired key and press  .
- To edit the names of Flexible Keys, see page 14.
- For more information, refer to the feature documentation for your PBX.

Making Calls

Calling

To an extension



To an outside party

-Using the Line Access Numbers



-Using Flexible Keys

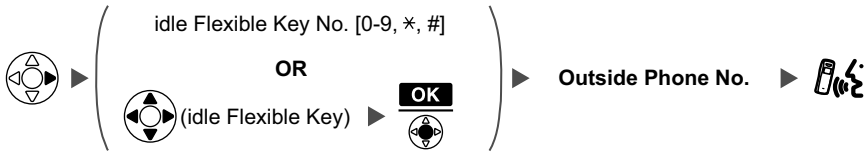

Using the Outgoing Call Log^{*1}



Using the Incoming Call Log



Using the Incoming Call Log Group



Using the Handset Phonebook^{*2}

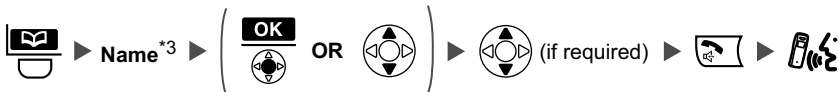

Operation

Calling

Using the PBX System Phonebook*1*2

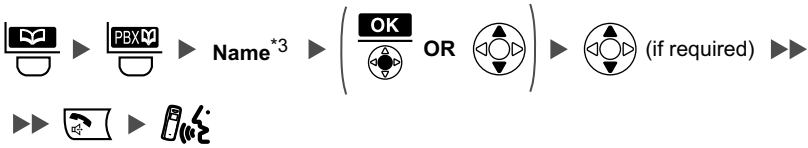

Using the PBX Extension Phonebook*2

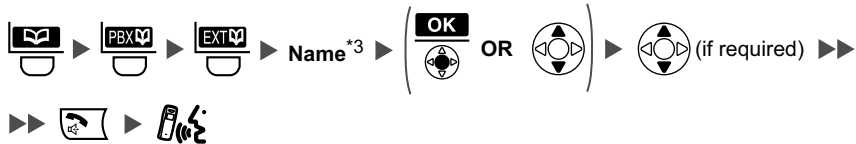

One-touch Dialling

To store

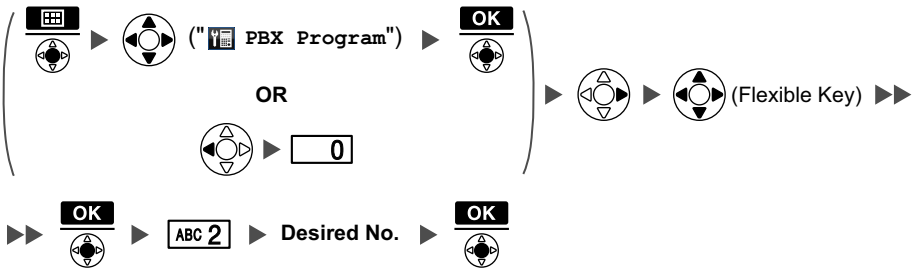

To dial



Hot Key Dialling*4

To dial

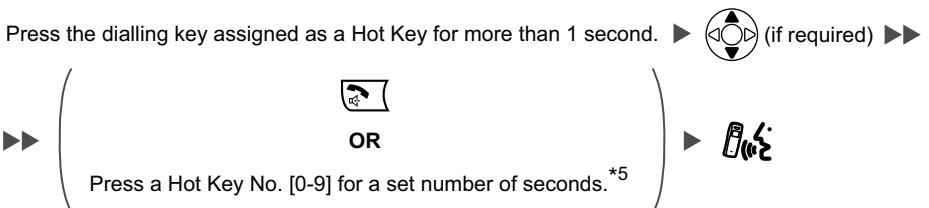

Hot Line

To store



To set/cancel



To dial



Operator Call

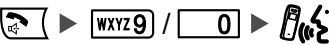

System Speed Dialling

To dial



Doorphone Call



Automatic Callback Busy

To set

While hearing a busy tone



To cancel



To answer from an idle extension

While hearing a callback ring





To answer from an idle outside line

While hearing a callback ring



- *1 When a call is made using the PBX System Phonebook, the called party's name is not stored in the Outgoing Call Log. To log the name as well as the number, copy the item into the Handset Phonebook before dialling it. (See page 50.)
- *2 To store an item in the Phonebook, see page 45.
To search for an item stored in the Phonebook, see page 29.
- *3 This step can be omitted.
- *4 To assign a phone number to a Hot Key, see page 53.
- *5 This operation is available only when Hot Key dialling is set to "Auto". To select the type of Hot Key dialling, see page 54.

Operation

- To enter characters, see page 55.
- You can confirm that the number was dialled correctly before calling (**Predialling**) by entering the number, then pressing .
- To clear an entire number while predialling, press  for more than 1 second.
- If an outside call is received from a phone number stored in the Handset Phonebook, the number and name of the caller will be displayed in the call log.
- To cancel dialling, press .
- If " ∇ " flashes, move closer to the CS and dial again.
- For more information, refer to the user documentation for your PBX.

Searching for an item stored in the Phonebook

You can search for an item in the Phonebook by following the steps below.

Handset Phonebook

Scrolling through all items

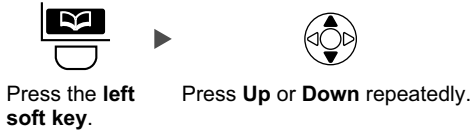

Searching by name or first character(s) of name

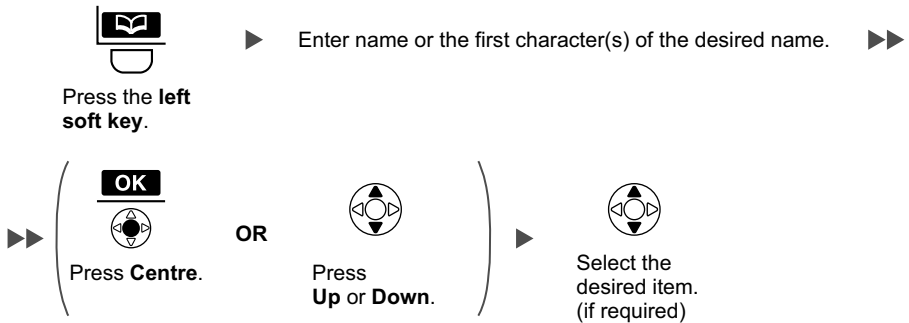

Searching using first characters of name to narrow down items

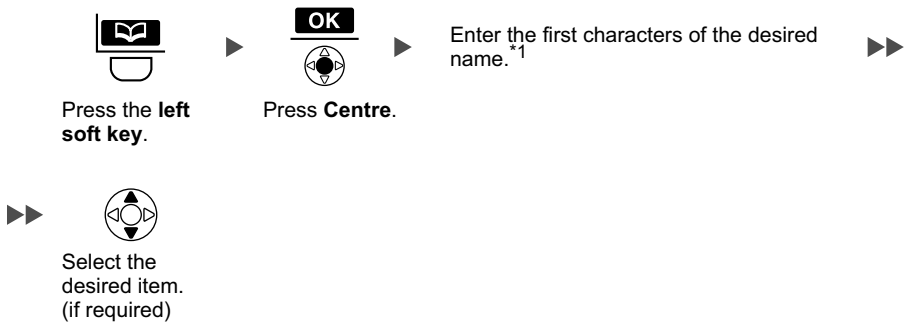

Operation

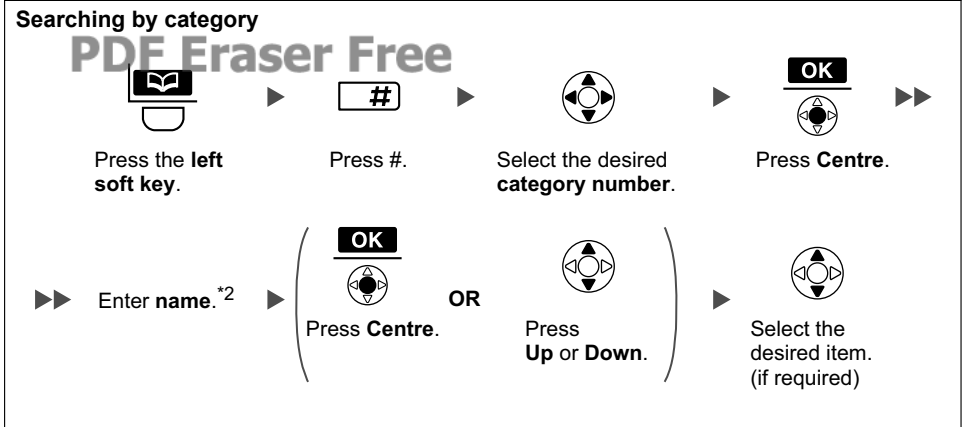

*1 You can enter up to 5 characters. Corresponding names appear as the characters are entered.

*2 This step can be omitted.

- To enter characters, see page 55.
- While an item is displayed you can:
 - Return to the "<Enter Name>" display by pressing , then search for another item.
 - Search for another item by pressing the dial key that corresponds to the letter you are searching for. If there is no entry that corresponds to the letter you selected, the next entry will be displayed.

PBX System Phonebook

Scrolling through all items



Press the **left soft key**.



Press the **left soft key**.



Press **Up** or **Down** repeatedly.

Searching by name or first character(s) of name



Press the **left soft key**.



Press the **left soft key**.



Enter name or the first character(s) of the desired name.

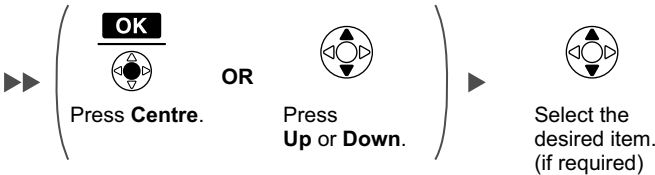

- To enter characters, see page 55.
- While an item is displayed you can:
 - Return to the "<Enter Name>" display by pressing , then search for another item.
 - Search for another item by pressing the dial key that corresponds to the letter you are searching for. If there is no entry that corresponds to the letter you selected, the next entry will be displayed.

Operation

PBX Extension Phonebook

Scrolling through all items



Press the **left soft key**.



Press the **left soft key**.



Press the **left soft key**.



Press **Up** or **Down** repeatedly.

Searching by name or first character(s) of name



Press the **left soft key**.



Press the **left soft key**.



Press the **left soft key**.



Enter name or the first character(s) of the desired name. ►►



- To enter characters, see page 55.
- While an item is displayed you can:
 - Return to the "<Enter Name>" display by pressing , then search for another item.
 - Search for another item by pressing the dial key that corresponds to the letter you are searching for. If there is no entry that corresponds to the letter you selected, the next entry will be displayed.

Receiving Calls

Receiving

An Intercom Call/An Outside Call/A Group Call



An Intercom Call



An Outside Call on a specific line

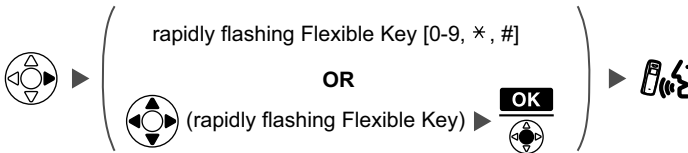

Call Pickup

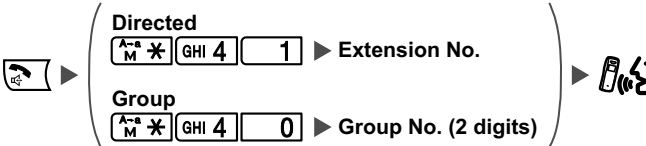

- You can also answer a call using the following features:
 - Any Key Answer (See "Answer Option" on page 65.)
 - Quick Answer (See "Answer Option" on page 65.)
 - Auto Answer (See "Answer Option" on page 65.)
- You can select the ringer, LED, and vibrate pattern for each type of incoming call. (See "Incoming Option" on page 64.)
- For more information, refer to the user documentation for your PBX.

Caller ID



If an outside call that contains Caller ID information (a caller's name and telephone number) is received, this information will be logged in the incoming call log and displayed on the handset in one of the two following ways:

- If the caller's information is stored in the PBX, that information can be displayed.

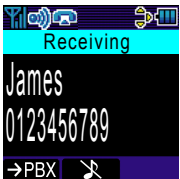

- If the caller's information is stored in the handset, that information can be displayed.



- If information is stored in both the PBX and in the handset for the same caller, you can choose which information will be displayed on the handset. Caller information stored in the PBX is displayed by default. (See "Display Option" on page 68.) If you set the handset to display the caller information stored in the handset, caller information stored in the PBX will only be displayed if the caller information is not stored in the handset. When receiving a call, you can display the information stored in the handset by pressing , and display the information stored in the PBX by pressing .
- The caller information can be displayed even if a line access number, outside line number, or P () is stored in the Phonebook. (See "Other Option" on page 71.)

During a Conversation

Transferring a Call

To an extension

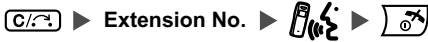

To an outside party

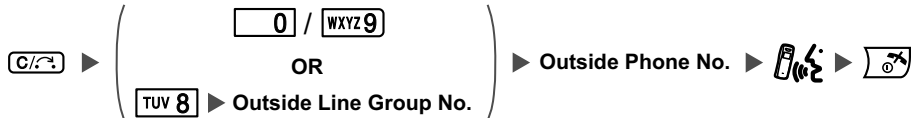

Holding

To hold (Regular Hold)



To hold (Exclusive Call Hold)

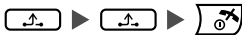

To retrieve a call

–An Intercom Call



–An Outside Call

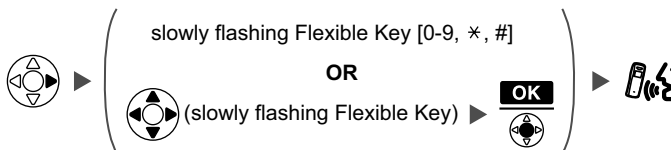

Three-party Conference

To add another party during a conversation



To leave a conference



Operation

- To return to the call before the transfer destination answers, press **C/↶**.
- The method used to hold a call depends on the Call Hold mode (Regular Hold/Exclusive Call Hold). Ask your manager what the current mode is.
- To hold several outside calls, you need to assign Flexible Keys (Single Line/Loop Line/Trunk Group) as necessary beforehand.
- For more information, refer to the user documentation for your PBX.

Useful Features

Call Forwarding

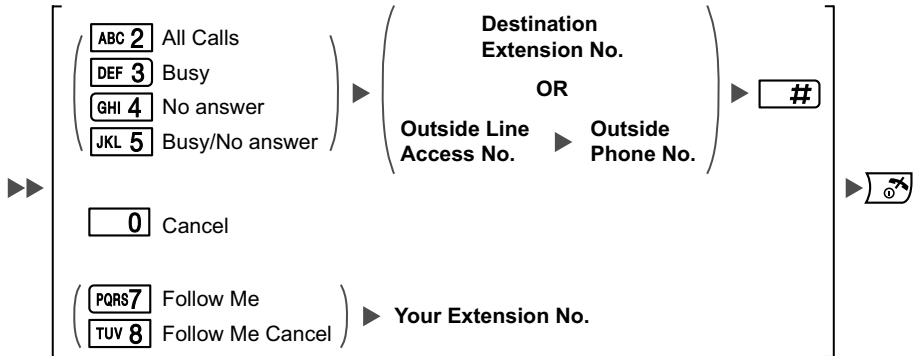
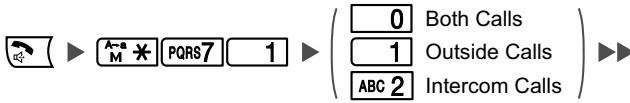

Do Not Disturb

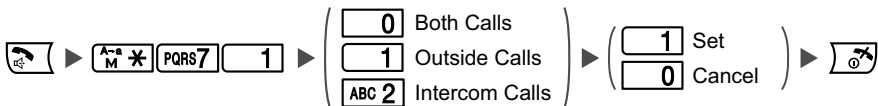

Sending a Call Waiting Tone*1

While hearing a busy tone

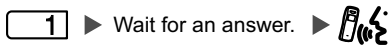

Call Waiting

To set/cancel for intercom calls

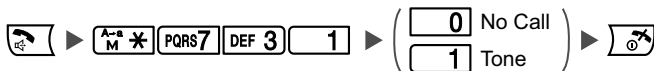

To set/cancel for outside calls

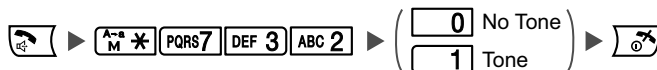

Call Waiting

To talk to the new party (While hearing the Call Waiting tone)

-To terminate the current status



-To hold and then talk to the new party

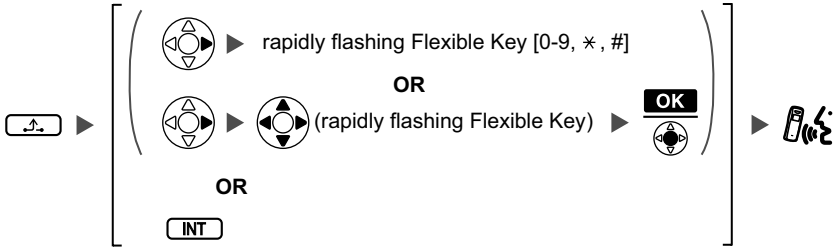

Disregard this step if both parties are extensions.

Paging

To page

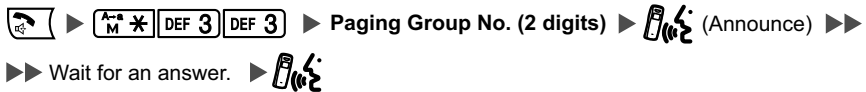

To answer

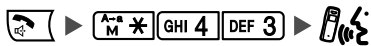

Absent Message

To set

► P Q R S 7 J K L 5 0 ►

1	Will Return Soon
2	Gone Home
3	At Ext %%% + Extension No.
4	Back at %:%: + Hour:Minute
5	Out until %:/%/ + Month/Day
6	In a Meeting
7	
8	
9	

►► ►

*2

Enter required no.

To cancel

► P Q R S 7 J K L 5 0 0 ►

Log-in/Log-out

► P Q R S 7 D E F 3 M N O 6 1 ► P Q R S 7 D E F 3 M N O 6 0 ►

* ICD Group: Incoming Call Distribution Group

Extension Feature Clear

► P Q R S 7 W X Y Z 9 0 ►

Extension Dial Lock^{*3}

To lock

► P Q R S 7 P Q R S 7 1 ►

To unlock

► P Q R S 7 P Q R S 7 0 ► Extension PIN* (max. 10 digits) ►

* PIN: Personal Identification Number

Message Waiting

Caller

-To leave a message waiting indication

When the called extension is busy or does not answer



-To cancel a message waiting indication



Called extension

-To call back

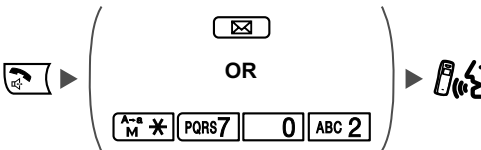

-To clear message waiting indications left on your extension*4

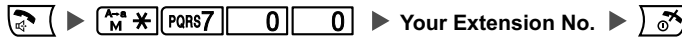

*1 You cannot send a call waiting tone when:

- the called party has not set the Call Waiting feature.
- the called party has set the Data Line Security feature.

*2 Enter the desired value in the "%" positions. You must enter the correct number of characters as represented by the "%" using 0 to 9 or *.

To change the default messages and create your personal messages (Message no. 9), refer to the documentation for your PBX.

*3 If you do not set an extension PIN, you cannot lock and unlock your extension.

For more information, refer to the user documentation for your PBX.

*4 You can register a Flexible Key to the clear message waiting indications feature (for one-touch operation).

To register

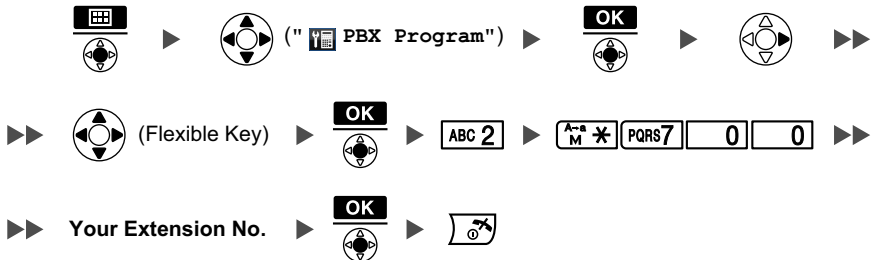

To clear message waiting indications (one-touch operation)

PDF Eraser Free



(One-touch dialling key)



OK





- For more information, refer to the user documentation for your PBX.

Making Use of the Voice Mail Service

Listening to a Message





From your own extension

 ► VPS* Extension No. ►►
►► Mailbox Password*¹ + 

- If you have no password, you can skip the last step.







* VPS: Voice Processing System

From someone else's extension







 ► VPS Extension No. ►►
►►  MNO6 ►  ►►
►► Mailbox No. ►►
►► Mailbox Password*¹ + 

- If you have no password, you can skip the last step.

KX-TVM series

►  Listen to Message
 Deliver Message
 Mailbox Management
 Automated Attendant
 Message Notification
 Other Features
 End Call

KX-TVP series

►  Listen to Message
 Deliver Message
 Check Mailbox Distribution
 Automated Attendant
 Mailbox Management
 Other Features
 End Call

Leaving a Message

PDF Eraser Free

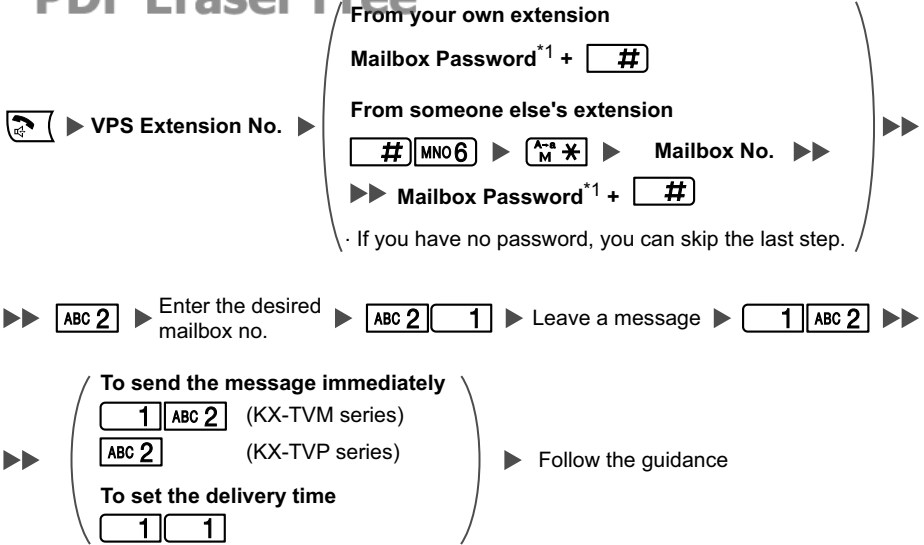

During Playback

0 Repeat Voice Guidance

A-M * Exit Menu

- *1 For more information on the Mailbox Password, refer to the user documentation for the VPS.
- Some feature access numbers may vary depending on the market. Please consult your local dealer for details.

Handset Phonebook

You can store up to 200 items with names, phone numbers, and category numbers in the handset for easy access. You can set unique Ringer/LED/Vibrate patterns for each category to identify incoming calls. All Phonebook items are stored in alphabetical order. For security purposes, you can lock the Phonebook. To make a call using the Phonebook, see page 25.

Note

We recommend that you keep a copy of your Handset Phonebook in case data becomes unrecoverable due to product malfunction.

Private Ring

You can organise entries in the Phonebook into one of 9 Private Ring Categories. It is possible to set a different ringer/LED/vibrate pattern*¹ for each category. When the displayed Caller ID*² matches a phone number or name stored in the Phonebook, the handset rings according to the Private Ring Category settings.

*1 For Ringer/LED/Vibrate patterns, see "Incoming Option" on page 64.

*2 For Caller ID information, see "Caller ID" on page 34.

Storing an Item in the Handset Phonebook

Storing a New Item

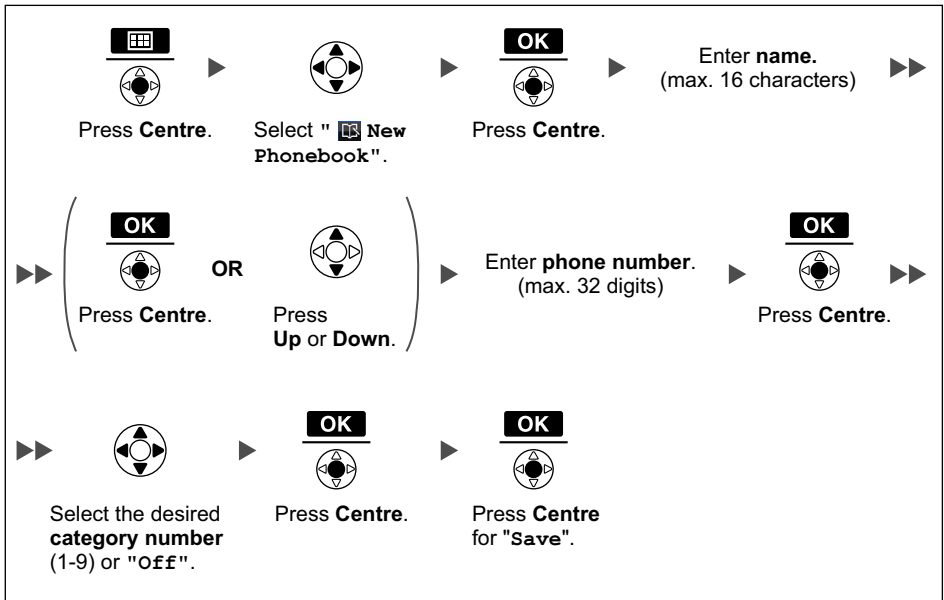



- To enter characters, see page 55.
- The valid digits are "0" through "9", "*", "#", "P ()".
- When storing an outside phone number, you should first store a line access number.

Editing a Stored Item

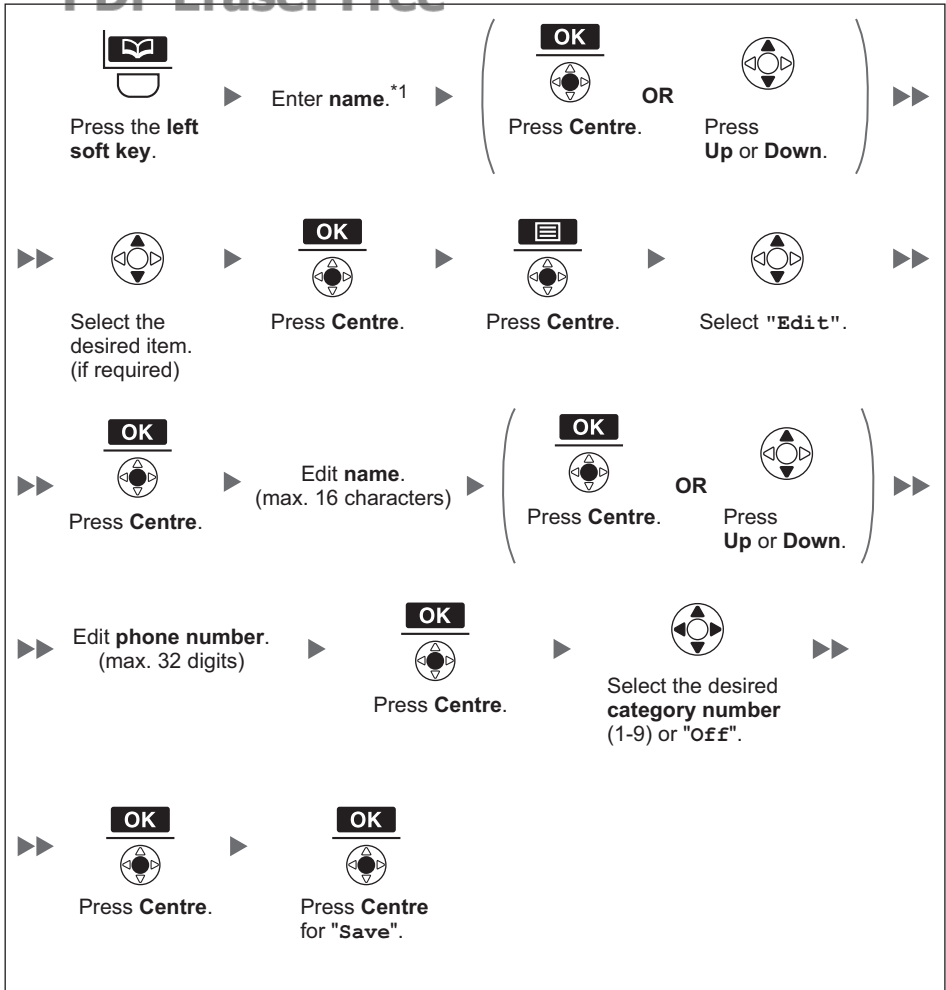
PDF Eraser Free



*1 This step can be omitted.

- To enter characters, see page 55.
- To search for an item in the Phonebook, see page 29.
- The valid digits are "0" through "9", "*", "#", "P ()".
- To change a character or digit, press the Navigator Key ◀ or ▶ to highlight it, press  to delete it, then enter the new character or digit.
- To clear an entire line, press  for more than 1 second.
- To move the cursor to the left or right, press the Navigator Key ◀ or ▶, respectively.



Storing an Item Using the Predialling

Enter **phone number**.
(max. 32 digits)



Press **Centre**.

Enter **name**.
(max. 16 characters)

▶▶ (  OR ) ▶

Press **Centre**. OR Press **Up or Down**.

Edit **phone number**.
(max. 32 digits)
(if required)



Press **Centre**.



Select the desired **category number** (1-9) or "Off".



Press **Centre**.



Press **Centre** for "Save".

Storing an Item Using the Outgoing Call Log

PDF Eraser Free

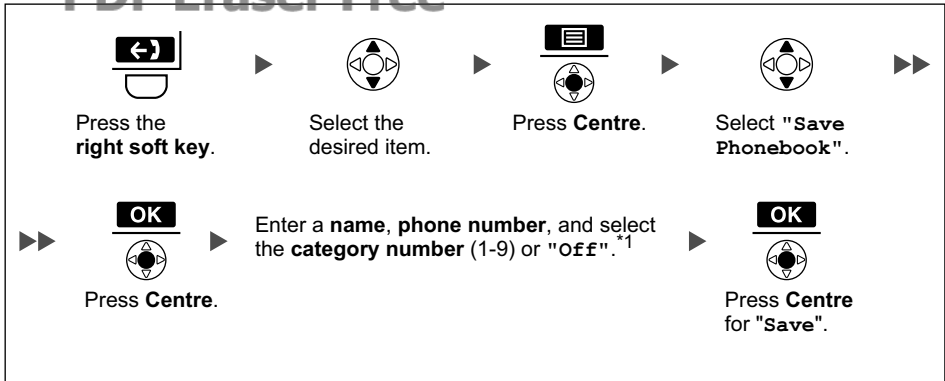

*1 Press  to confirm each entry. (**name**: max. 16 characters/**phone number**: max. 32 digits)

- When storing an outside phone number, the line access number will be stored automatically. The line access number must be identical to the handset's "Line Access CD" setting. (See "Other Option" on page 71.)

Storing an Item Using the Incoming Call Log

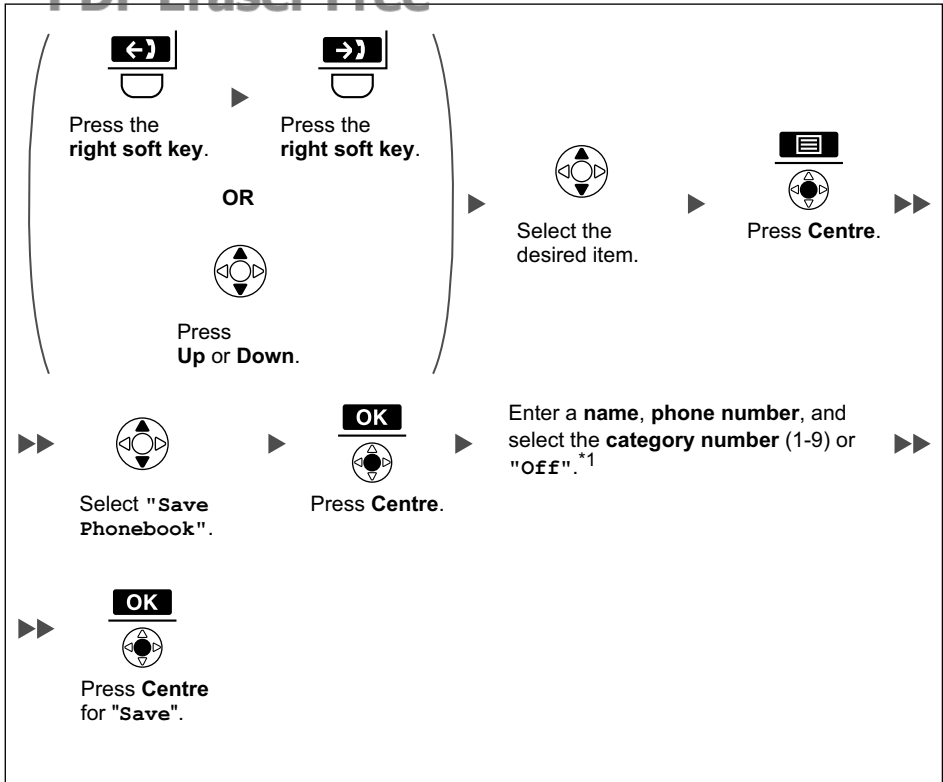

*1 Press to confirm each entry. (**name**: max. 16 characters/**phone number**: max. 32 digits)

- When storing an outside phone number, the line access number will be stored automatically. The line access number must be identical to the handset's "Line Access CD" setting. (See "Other Option" on page 71.)

Storing an Item Using the PBX System Phonebook

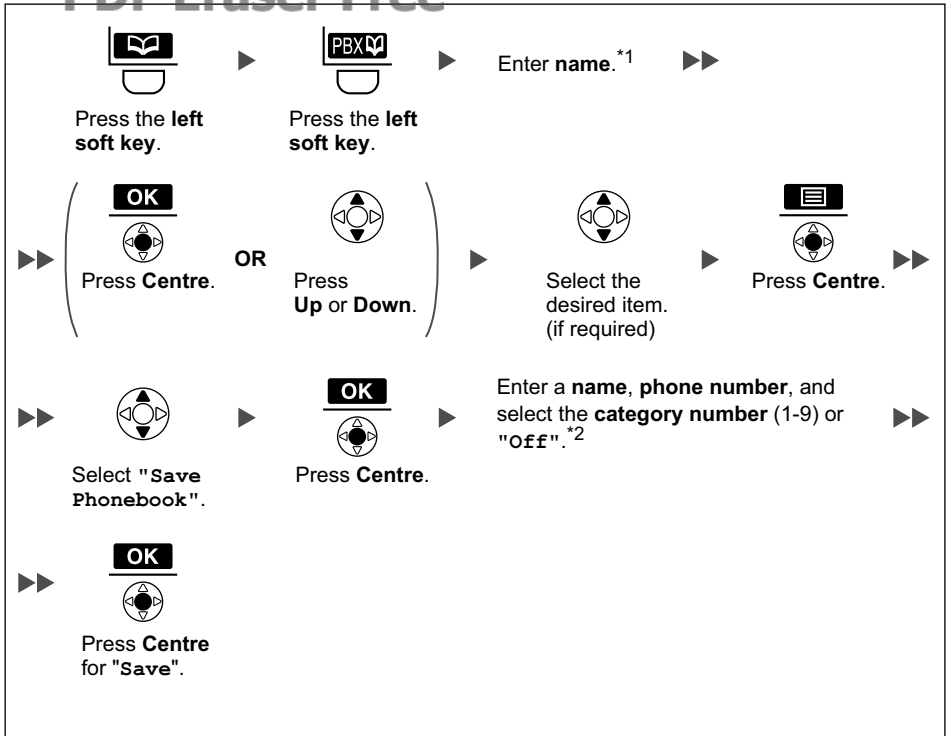

*1 This step can be omitted.

*2 Press  to confirm each entry. (**name**: max. 16 characters/**phone number**: max. 32 digits)

- To search for an item in the Phonebook, see page 29.

Storing an Item Using the PBX Extension Phonebook

PDF Eraser Free

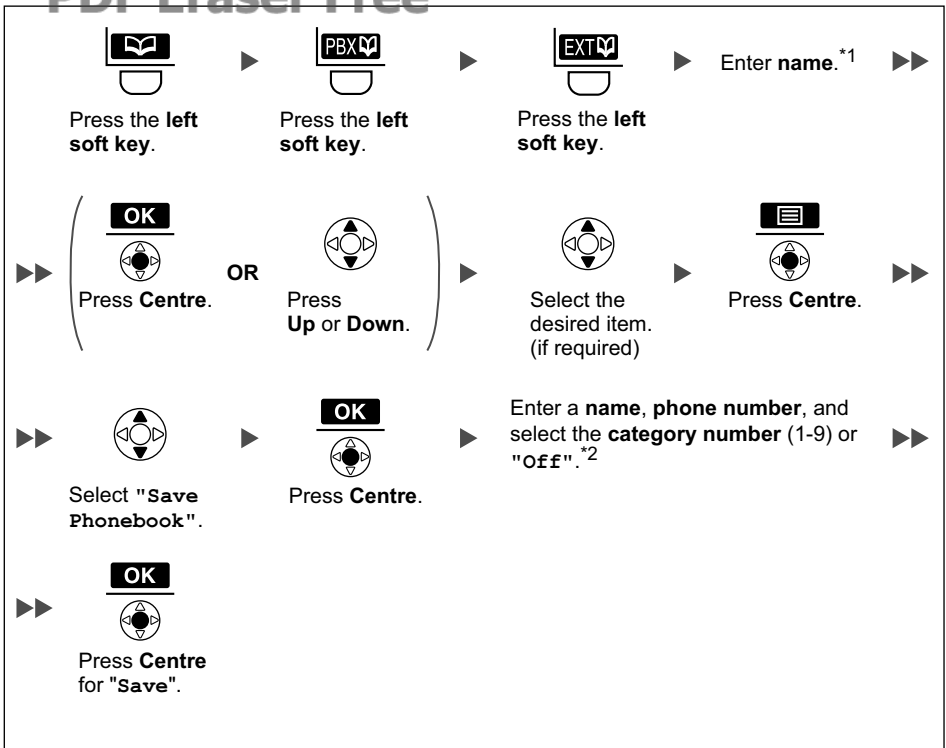

*1 This step can be omitted.

*2 Press  to confirm each entry. (**name**: max. 16 characters/**phone number**: max. 32 digits)

- To search for an item in the Phonebook, see page 29.

Editing Category Names

You can edit the names of the categories in the Handset Phonebook.

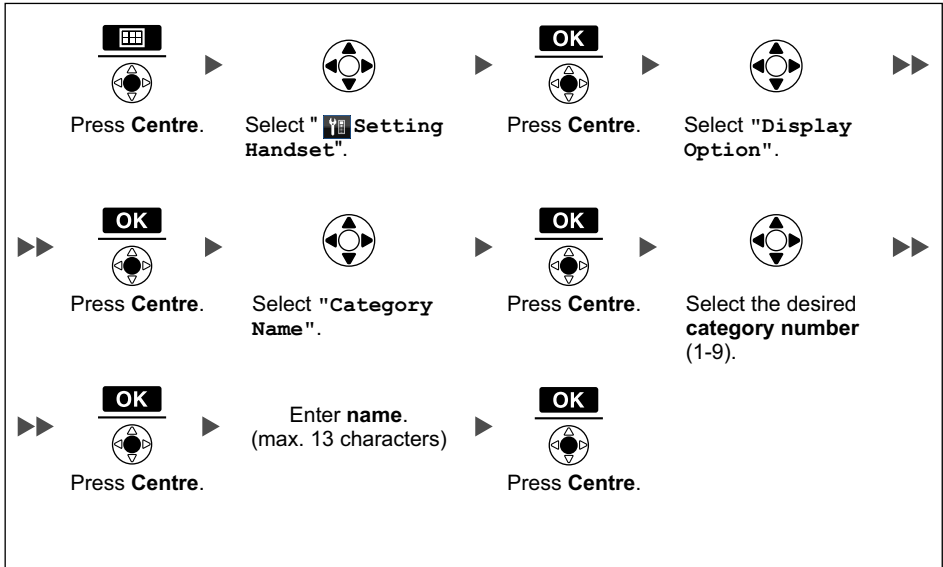

Assigning Hot Keys

You can assign a phone number stored in the Handset Phonebook to a key to be used as a Hot Key.

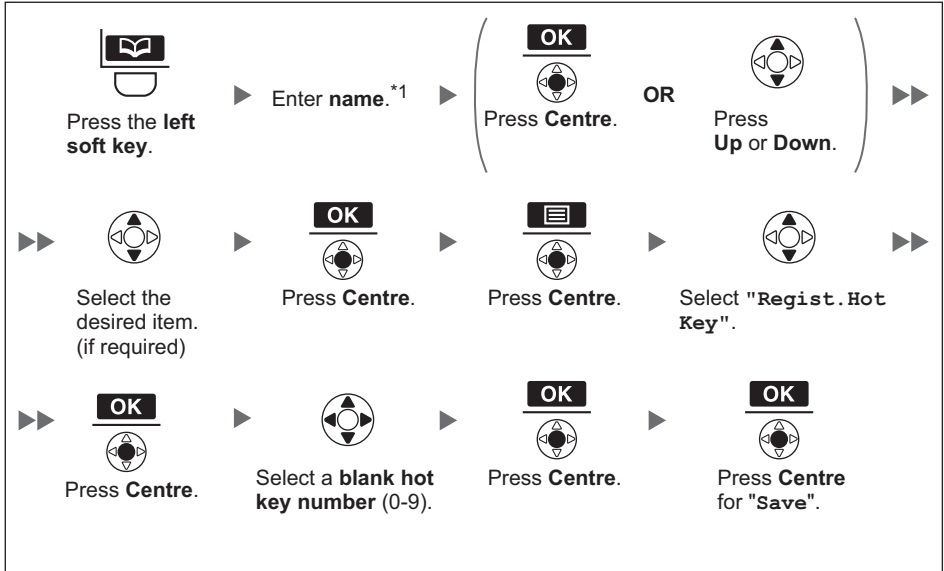

*1 This step can be omitted.

- To search for an item in the Phonebook, see page 29.
- A "✓" will be displayed next to hot key numbers that have a Phonebook item registered to them.

Selecting the Type of Hot Key Dialling

You can select one of 2 types of Hot Key Dialling for each assigned Hot Key.

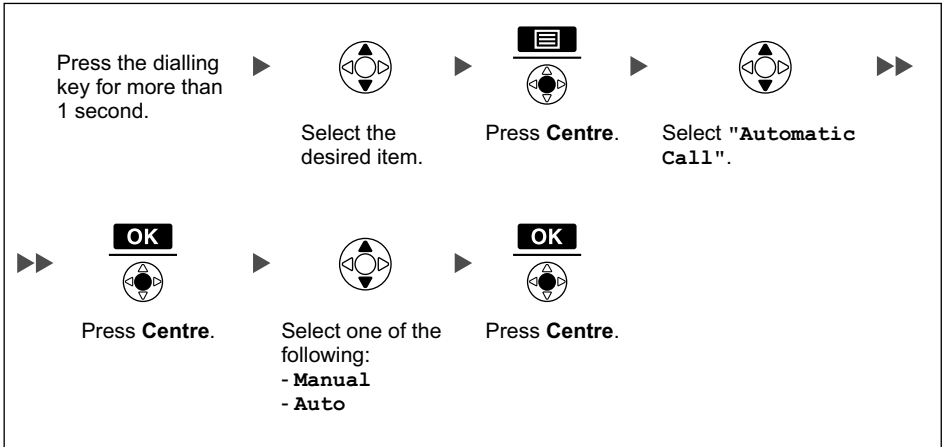

- To select the number of seconds before the call is automatically made, see "Key Option" on page 66.

Entering Characters

You can enter characters and digits using the dialling keys.

You can select one of 5 character modes by pressing the **Right Soft Key** while entering a name. The function icon above the soft key displays the current character mode.

For available characters, see "Character Mode Table" (page 56).

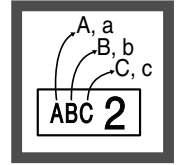

To change the character mode while editing a name in the Phonebook, press the **right soft key**.

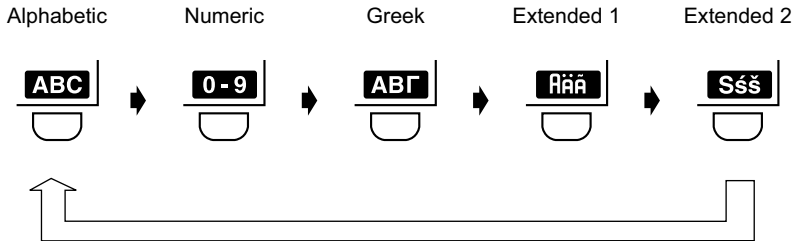

Example: To enter "Anne" in Alphabet Mode.



- To switch between uppercase and lowercase, press **A-M ***.
- To enter a character located on the same dialling key as the previous character, move the cursor by pressing the Navigator Key **▶**, then enter the desired character.
- If you enter a different character by mistake, press the Navigator Key **◀** or **▶** to highlight the character, press **C/↶** to delete it, then enter the correct character.
- To clear an entire line, press **C/↶** for more than 1 second.
- To move the cursor, press the Navigator Key **◀**, **▶**, **▲** or **▼**.

Character Mode Table

Keys	ABC (Alphabetic)	0-9 (Numeric)	ΑΒΓ (Greek)	ÄÅ (Extended 1)	ŠŠ (Extended 2)
1	Space # & ' () * , - . / 1	1	Space # & ' () * , - . / 1		
ABC 2	ABC 2	2	Α Β Γ 2	Ä Ä Ä Ä Ä Ä Æ Β Ç 2	Ä Ä Ä Ä Β C Č Č 2
	abc 2			ä ä ä ä ä ä æ β ç 2	ä ä ä Ä β c Č Č 2
DEF 3	DEF 3	3	Δ Ε Ζ 3	Đ Ě Ę Ę Ę Ę F 3	Đ Ě Ę Ę Ę F 3
	def 3			de ě é ě ě ě f 3	d ě é Ę ě f 3
GHI 4	GHI 4	4	Η Θ Ι 4	Ĝ Ğ Ĩ ĩ ĩ ĩ ĩ 4	G Ĩ Í 4
	ghi 4			g ĝ ħ ĩ ĩ ĩ ĩ ĩ 4	gh ĩ 4
JKL 5	JKL 5	5	Κ Λ Μ 5	JKL 5	JKL Ł Ł Ł 5
	jkl 5			jk l 5	jk l Ł Ł Ł 5
MNO 6	MNO 6	6	Ν Ξ Ο 6	MN Ń Ō Ő Ő Ŏ ø 6	MN Ń Ń Ō Ő Ő Ŏ 6
	mno 6			m n ñ o ó ô õ ö ø 6	m n Ń ñ o ó ô õ ö ø 6
PQRS 7	PQRS 7	7	Π Ρ Σ 7	PQRS Š Œ 7	PQR Ř Ŕ Š Š Š 7
	pqrs 7			p q r s Š Œ 7	p q r Ř ř s Š Š 7
TUV 8	TUV 8	8	Τ Υ Φ 8	TU Ū Ū Ū Ū Ū V 8	T Ť Ū Ū Ū Ū Ū V 8
	tuv 8			tu ú ú ū ū ū v 8	t ť u ú ú ū ū v 8
WXYZ 9	WXYZ 9	9	Χ Ψ Ω Ξ 9	W Ŵ X Y ŷ Z 9	W X Y ŷ Y Z Ž Ž Ž 9
	wxyz 9			w Ŵ x y ŷ z 9	w x y ŷ y z Ž Ž Ž 9
0	Space 0	0	Space 0		

- Press **[M*]** before or after entering a character to change between uppercase and lowercase.
- Pressing a key repeatedly will cycle through the characters associated with that key. For example, to enter the letter "C" in Alphabet Mode, press **ABC 2** 3 times.

Locking the Handset Phonebook

You can lock/unlock the Phonebook while the handset is in standby mode. If no password has been set, you cannot lock the Phonebook. To set the password, see "Setting the Password" on page 8.

Locking the Handset Phonebook



Unlocking the Handset Phonebook

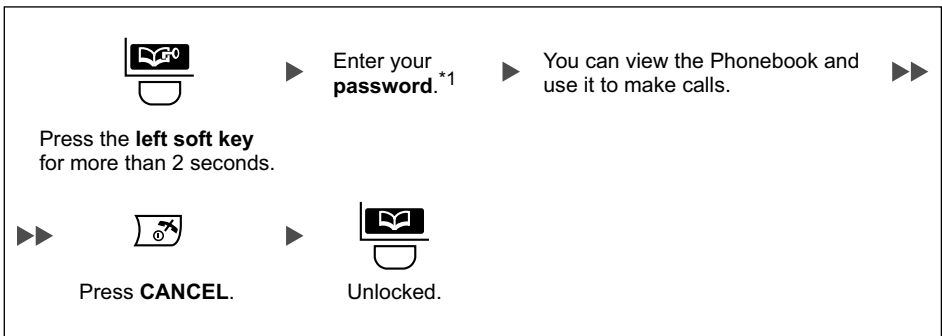

Unlocking the Handset Phonebook Temporarily

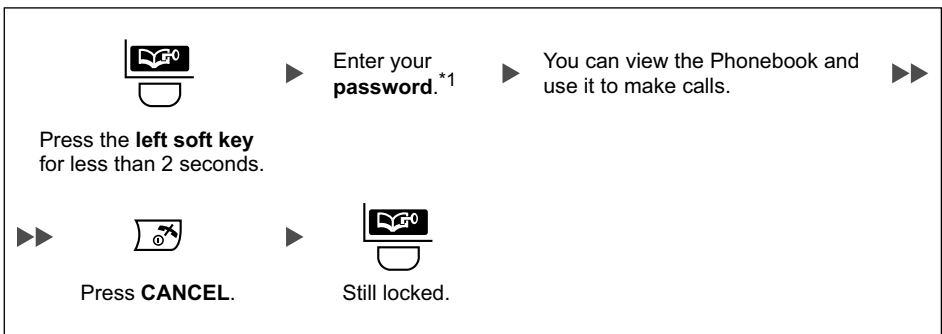

*1 To change the password, see page 71.

Deleting Stored Items in Handset Phonebook/Hot Key Dial/Outgoing Call Log/Incoming Call Log

Handset Phonebook

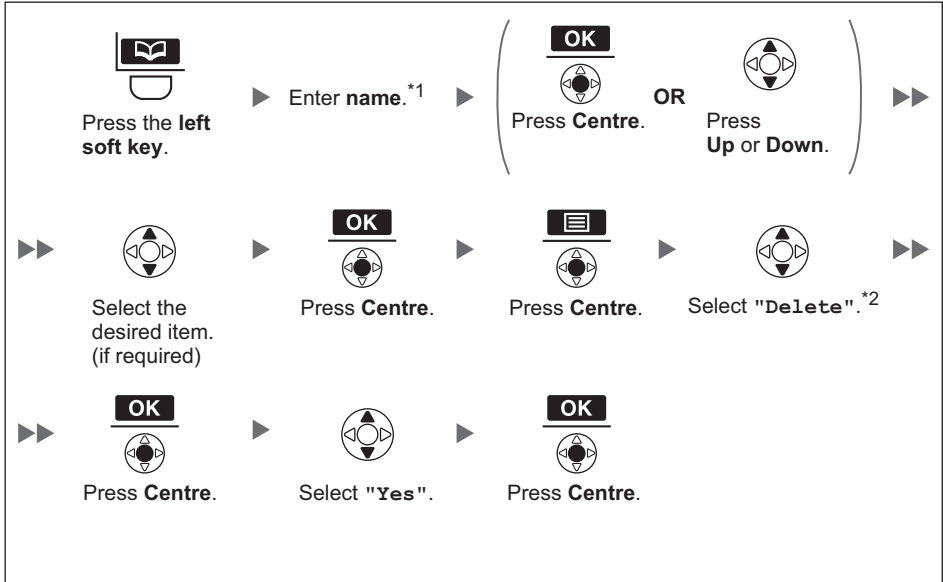

*1 This step can be omitted.

*2 Select "Delete All" if you want to delete all items.

- To search for an item in the Phonebook, see page 29.

Hot Key Dial

PDF Eraser Free

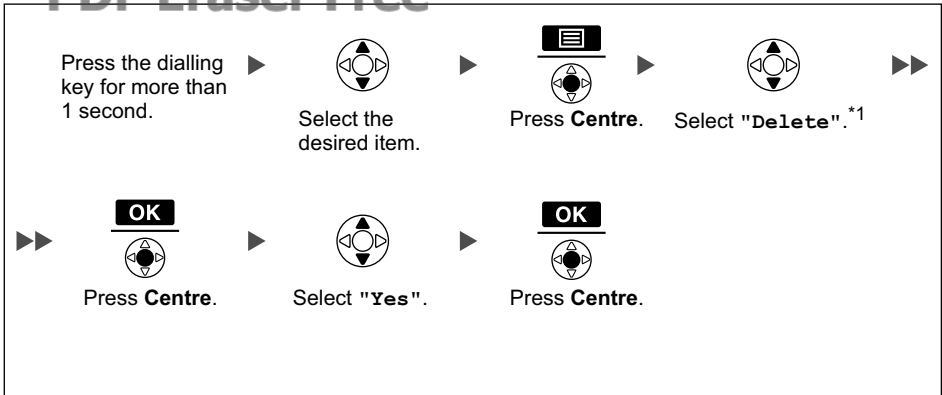

*1 Select "Delete All" if you want to delete all items.

- If you delete a Phonebook item that you also assigned to a Hot Key, the Hot Key Dial is also deleted. (See page 53.)

Deleting Stored Items

Outgoing Call Log

PDF Eraser Free

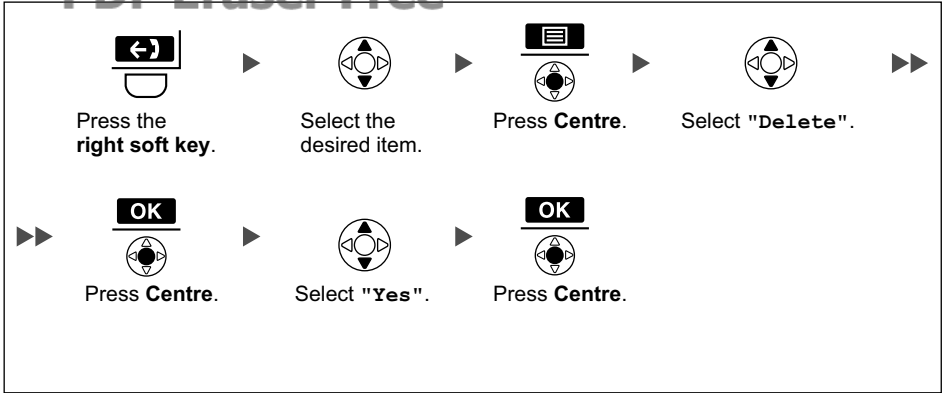

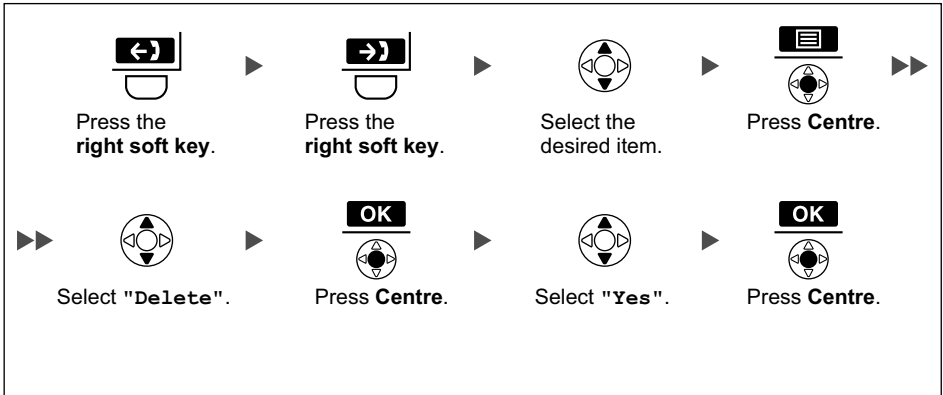

Incoming Call Log

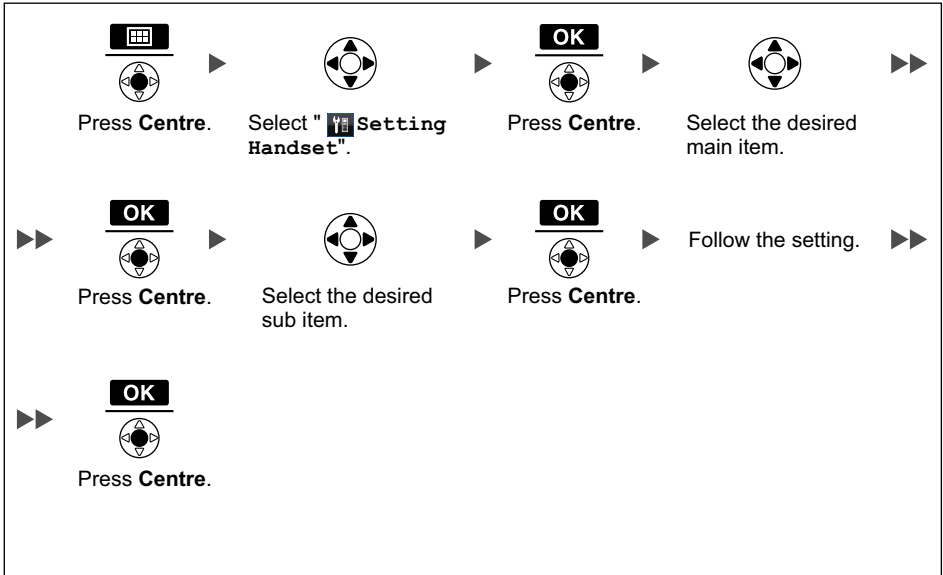

Changing the Initial Settings

You can customise the handset by editing the settings found under "Setting Handset" in the menu list, as follows:



- To return to the previous menu item, press .
- To cancel, press  at any time.
- The handset will beep to indicate that the new settings have been saved.

Handset Setting Menu Layout

	[Main Item]	[Sub Item]
 Setting Handset	— Incoming Option	— Ringer Volume
		Ringer Type
		Vibrate
		Ring On Charger
		Memo Alarm
		Power Save
		└ Headset Ringer
	— Talk Option	— Speaker Volume
		Receiver Volume
		Headset Volume
		Headset Mic Vol
		Talk On Charger
		└ Headset Button
	— Answer Option	— Any Key Answer
		Quick Answer
		Auto Answer
		└ Auto Ans Delay
	— Key Option	— Flex Key Name
		Function Key
		Soft Key Edit
		Soft Key Name
		Key Lock Type
		Auto Lock Time
		└ Hot Key Time
— Display Option	— Language	
	Backlight	
	LCD Contrast	
	Standby Display	
	Category Name	
	Guidance	
	Date&Time Form	

PDF Eraser Free

|
├ Tone Option

|
├ System Option

|
└ Other Option

├ Caller ID Disp

└ Colour Scheme

├ Key Tone

└ Range Alarm

├ Register H/S

└ Cancel Base

└ Select Base

└ System Lock

└ Change PIN

├ Change Password

└ Line Access CD

└ Reset Handset

Configuring Handset Settings

Incoming Option

Sub Item	Description	Setting	Default
Ringer Volume	Adjusts the ringer volume.	<input type="checkbox"/> Step Up <input type="checkbox"/> Step Down <input type="checkbox"/> Level 1-6 <input type="checkbox"/> Off	Level 3
Ringer Type – Intercom Ring – Ext Ring – Group Ring – Private Ring (Category 1-9)	Ringer Pattern Selects the ringer pattern for each type of call.	<input type="checkbox"/> Bell 1-10 <input type="checkbox"/> Melody 1-10	Bell 1
	LED Pattern Selects the LED pattern for each type of call.	<input type="checkbox"/> Red <input type="checkbox"/> Green <input type="checkbox"/> Orange <input type="checkbox"/> R→ G→ O	Ext Ring: Red Intercom Ring/ Private Ring: Green Group Ring: Orange
	Vib. Pattern Selects the vibrate pattern for each type of call.	<input type="checkbox"/> Single <input type="checkbox"/> Double <input type="checkbox"/> Triple	Single
Vibrate	Selects whether the handset vibrates while receiving a call.	<input type="checkbox"/> Vib.& Ring <input type="checkbox"/> Vib.→ Ring <input type="checkbox"/> Off	Off
Ring On Charger	Selects the ringing mode (On or Off) while a handset is set on the charger.*1	<input type="checkbox"/> On <input type="checkbox"/> Off	On
Memo Alarm	Ringer Pattern Selects the ringer pattern for each Memo Alarm.	<input type="checkbox"/> Bell 1-10 <input type="checkbox"/> Melody 1-10	Bell 1
	LED Pattern Selects the LED pattern for each Memo Alarm.	<input type="checkbox"/> Red <input type="checkbox"/> Green <input type="checkbox"/> Orange <input type="checkbox"/> R→ G→ O	Green
	Vib. Pattern Selects the vibrate pattern for each Memo Alarm.	<input type="checkbox"/> Single <input type="checkbox"/> Double <input type="checkbox"/> Triple	Single

Configuring Handset Settings

Sub Item	Description	Setting	Default
Power Save	Power Save Time Selects the number of seconds before automatically turning off the Power Save Items below when receiving a call.	0 s-60 s	30 s
	Power Save Item Selects the items to turn off.	<input type="checkbox"/> Ringer&Vibrate <input type="checkbox"/> Backlight	Not selected
Headset Ringer	Selects whether a tone is heard from the attached headset while receiving a call.	<input type="checkbox"/> On <input type="checkbox"/> Off	Off

*1 When "Ring On Charger" is set to "On" but "Ringer Volume" is set to "Off", the handset rings at level 1.

Talk Option

Sub Item	Description	Setting	Default
Speaker Volume	Adjusts the rear speaker volume.	Level 1-6	Level 3
Receiver Volume	Adjusts the receiver volume.	Level 1-5	Level 3
Headset Volume	Adjusts the headset speaker volume.	Level 1-5	Level 2
Headset Mic Vol	Adjusts the headset microphone volume.	Level 1-5	Level 1
Talk On Charger	Selects whether or not to continue the conversation when the handset is put on the charger during a conversation.	<input type="checkbox"/> On <input type="checkbox"/> Off	Off
Headset Button *1	Selects whether to mute or disconnect a current call by pressing the headset key during a conversation.	<input type="checkbox"/> Mute <input type="checkbox"/> Terminate	Mute

*1 For details regarding compatible headsets, consult your dealer.

Answer Option

Sub Item	Description	Setting	Default
Any Key Answer	Answers a call by pressing any dialling key.	<input type="checkbox"/> On <input type="checkbox"/> Off	Off

Configuring Handset Settings

Sub Item	Description	Setting	Default
Quick Answer	Answers a call while the phone is charging by just lifting up a handset from the charger.	<input type="checkbox"/> On <input type="checkbox"/> Off	Off
Auto Answer	Selects the types of calls that can be answered by Auto Answer.	<input type="checkbox"/> Internal Only <input type="checkbox"/> Int&External	Internal Only
Auto Ans Delay	Selects the number of seconds before a call is automatically answered when Auto Answer is turned on.	0 s-20 s	6 s

Key Option

Sub Item	Description	Setting	Default
Flex Key Name	Edits the names of the Flexible Keys.	Max. 12 characters x 12 Flexible Keys x 4 bases	Not stored
Function Key	Edits the Function Key list.	<input type="checkbox"/> Redial <input type="checkbox"/> Fwd/DND <input type="checkbox"/> Flash/Recall <input type="checkbox"/> Auto Answer <input type="checkbox"/> Conference <input type="checkbox"/> Pause <input type="checkbox"/> Auto Dial <input type="checkbox"/> H/S Phonebook <input type="checkbox"/> PBX Phonebook <input type="checkbox"/> EXT Phonebook <input type="checkbox"/> PBX Program <input type="checkbox"/> Incoming Log <input type="checkbox"/> Incoming LogGrp <input type="checkbox"/> Outgoing Log <input type="checkbox"/> None* ¹	1: Redial 2: Fwd/DND 3: Flash/Recall 4: Auto Answer 5: Conference 6: Pause 7: H/S Phonebook 8: PBX Phonebook 9: EXT Phonebook 0: PBX Program *: Incoming Log #: Outgoing Log
Soft Key Edit - Softkey Left - Softkey Right	Edits the soft keys. - Standby - Talking	<input type="checkbox"/> Default <input type="checkbox"/> Flexible Key <input type="checkbox"/> Function Key <input type="checkbox"/> Hot Key Dial* ²	Not stored

Configuring Handset Settings

Sub Item	Description	Setting	Default
Soft Key Name – Softkey Left – Softkey Right	Edits the names of the soft keys. – Standby – Talking	Max. 5 characters	Not stored
Key Lock Type	Selects the type of key lock.	<input type="checkbox"/> Manual <input type="checkbox"/> Manual&Password ^{*3*4} <input type="checkbox"/> Auto <input type="checkbox"/> Auto&Password ^{*3*4}	Manual
Auto Lock Time	Sets the number of seconds before the handset key lock is activated when "Auto" is selected as the Key Lock Type.	0 s-60 s	10 s
Hot Key Time	Selects the number of seconds before a call is automatically made when a Hot Key assigned to "Auto" is pressed and held.	1 s-20 s	2 s

*1 Used to cancel the settings.

*2 Displayed only when "standby" is selected.

*3 To avoid unauthorised access to this product:

- Set a password that is random and cannot be easily guessed.
- Change the password regularly.

*4 If no password has been set, you cannot select "Manual&Password" or "Auto&Password" for Key lock type.

Configuring Handset Settings

Display Option

Sub Item	Description	Setting	Default
Language	Selects the display language.	<input type="checkbox"/> Auto <input type="checkbox"/> English <input type="checkbox"/> Deutsch <input type="checkbox"/> Español <input type="checkbox"/> FRANÇAIS <input type="checkbox"/> Italiano <input type="checkbox"/> Dansk <input type="checkbox"/> Nederlands <input type="checkbox"/> Svenska <input type="checkbox"/> Suomi <input type="checkbox"/> ΕΛΛΗΝΙΚΑ <input type="checkbox"/> Magyar <input type="checkbox"/> Português <input type="checkbox"/> Polski <input type="checkbox"/> slovensky <input type="checkbox"/> čeština <input type="checkbox"/> Hrvatski	Auto
Backlight	Turns on the backlight of the LCD and keypad.	<input type="checkbox"/> On <input type="checkbox"/> On & Receiving <input type="checkbox"/> Off	On
LCD Contrast	Adjusts the LCD contrast.	Level 1-5	Level 3
Standby Display	Selects what is shown on the display while in standby mode.*1	<input type="checkbox"/> Handset Number <input type="checkbox"/> Base & H/S No. <input type="checkbox"/> Edit	Handset Number
	Edits the name displayed on the LCD while in standby mode.	Max. 16 characters/4 digits	Not stored
Category Name	Edits the names of the categories.	Max. 13 characters x Category (1-9)	Not stored
Guidance	Selects whether the guidance display is shown or not in standby mode.	<input type="checkbox"/> On <input type="checkbox"/> Off	On

Configuring Handset Settings

Sub Item	Description	Setting	Default
Date & Time Form	Selects the format for the date shown on the display in standby mode.	<input type="checkbox"/> DD-MM 12H <input type="checkbox"/> DD-MM 24H <input type="checkbox"/> MM-DD 12H <input type="checkbox"/> MM-DD 24H <input type="checkbox"/> DD-MM-YY <input type="checkbox"/> MM-DD-YY	DD-MM 12H/ DD-MM 24H*2
Caller ID Disp	Selects which caller information is displayed when a call is received. Either the information stored in the Handset Phonebook or the PBX can be displayed.	<input type="checkbox"/> H/S Phonebook <input type="checkbox"/> PBX Setting	PBX Setting
Colour Scheme	Selects the colour scheme of the LCD.	<input type="checkbox"/> Dark <input type="checkbox"/> Light	Dark

*1 If an extension name is stored in the PBX, the extension name is displayed when "Handset Number" or "Base & H/S No." is selected. Depending on the number of characters stored for the extension name, the end of the extension name may not be displayed.

*2 The default setting for KX-TCA275CE is DD-MM 24H, and for KX-TCA275UK/KX-TCA275AL is DD-MM 12H.

Configuring Handset Settings

Tone Option

Sub Item	Description	Setting	Default
Key Tone	Turns the key tone on or off.	<input type="checkbox"/> On <input type="checkbox"/> Off	On
Range Alarm	Selects whether the range alarm tone rings or not.	<input type="checkbox"/> On <input type="checkbox"/> Off	On

System Option

Sub Item	Description	Setting	Default
Register H/S	Registers a handset to a base.	Base 1-4	Not stored
Cancel Base ^{*1}	Cancels the registration of a handset.	Base 1-4 ^{*2}	Not selected
Select Base ^{*1}	Selects a base.	<input type="checkbox"/> Auto <input type="checkbox"/> Base 1-4	Auto
System Lock	Selects whether to lock the System Option setting or not.	<input type="checkbox"/> On ^{*3} <input type="checkbox"/> Off	Off
Change PIN	Before registering your handset with a PBX, enter the PBX's PIN here. Once you have registered the handset with a PBX, this PIN can be changed so that the handset can be registered to an additional PBX.	Enter the PIN number. (max. 8 digits)	1234

*1 Only registered bases are shown.

*2 You can select multiple bases simultaneously.

*3 Password is required. (4 digits)

Other Option

Sub Item	Description	Setting	Default
Change Password ^{*1*2}	Changes the handset password (4 digits) used for unlocking the Handset Phonebook, using the Reset Handset option, and unlocking the key lock.	Enter Old Password. ^{*3} ↓ Enter New Password. ↓ Verify New Password.	Not registered
Line Access CD	Enters the line access code that matches the setting of your PBX. Three access line codes can be stored.	Select a number, then enter the code. (max. 6 digits)	No.1: 0/9 ^{*4} No.2: 8XX ^{*5} No.3: Not Stored
Reset Handset	Returns the handset settings to its default settings.	Enter Password. (4 digits) ↓ Select the desired item(s). ↓ Press "OK".	Not selected

*1 To avoid unauthorised access to this product:

- Set a password that is random and cannot be easily guessed.
- Change the password regularly.

*2 Make a note of the password so that you will not forget it.

*3 If a password has not already been set, you can skip the first step.

*4 The default setting for KX-TCA275CE/KX-TCA275AL is 0, and for KX-TCA275UK is 9.

*5 XX is identical to the Outside line group number, and 8XX represents any 3-digit code starting with "8".

Memo Alarm Setting

An alarm will sound at the set time. A memo can also be displayed. Memo Alarm is available only when the handset is within range of a CS.

To set

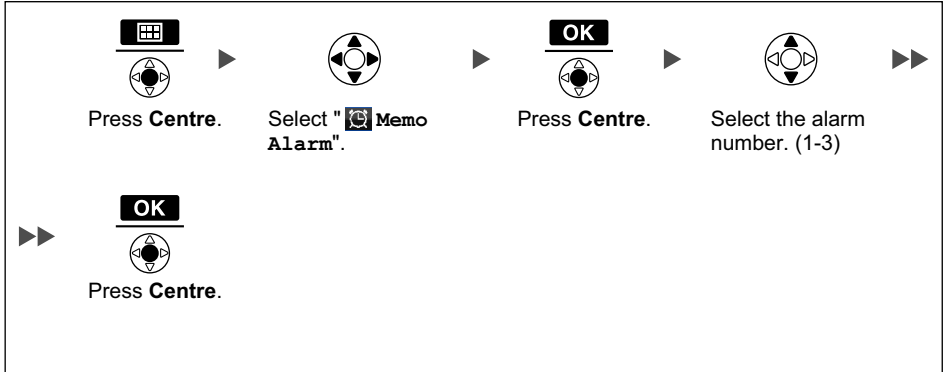

You can select the following settings:

- Alarm mode-Once/Daily
- Alarm mode-Weekly
- Alarm mode-Off

[Select the alarm mode-Once/Daily]

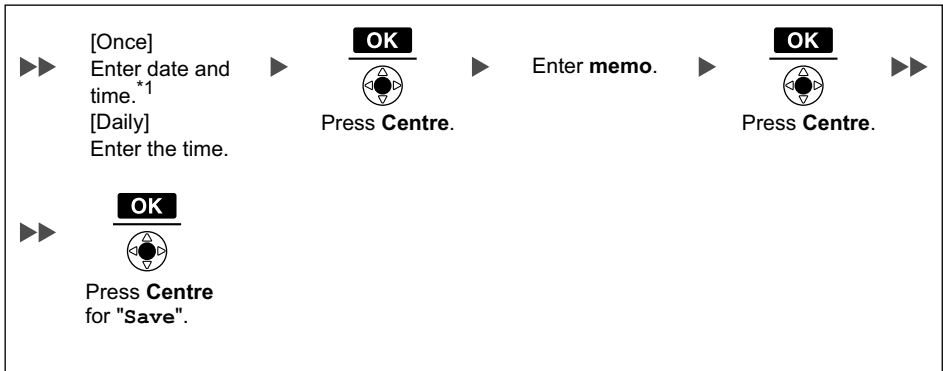

[Select the alarm mode-Weekly]*2

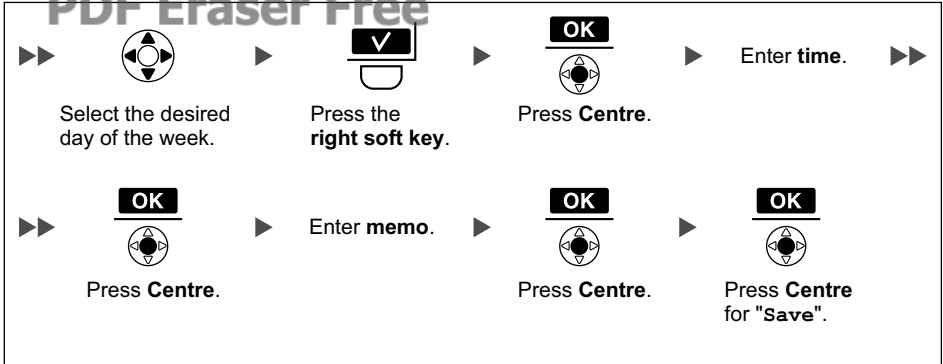

[Select the alarm mode-Off]



*1 You can select the format for the date and time. (See "Display Option" on page 68.)

*2 A "✓" will be displayed next to the day of the week that has been set.

- You can select the ringer/LED/vibrate pattern for each Memo Alarm. (See "Incoming Option" on page 64.)
- If you are on a call at the time that the alarm is set to sound, it will sound after you have ended the call.

Configuring Handset Settings

To delete the alarm mode setting

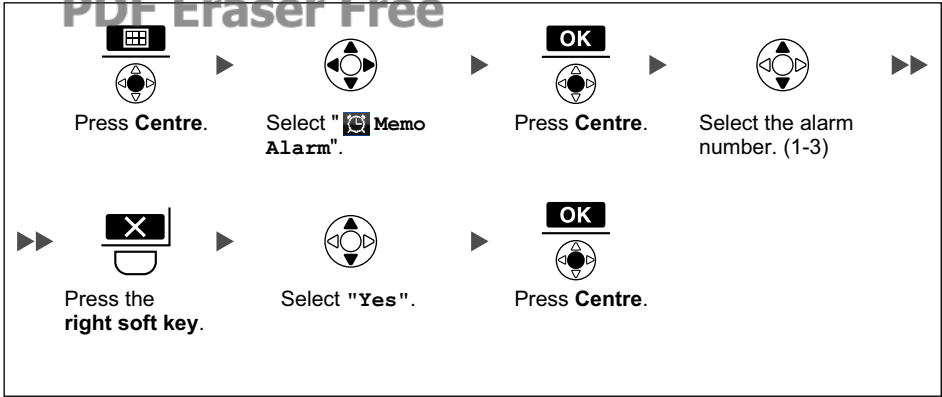

To stop the alarm

- Press any key other than soft keys.

Troubleshooting

Problem	Possible Cause	Solution
The handset does not work.	The battery is drained.	Charge the battery fully. (See "Charging the Battery" on page 6.)
	The power is off.	<ul style="list-style-type: none"> Turn it on. (See "Location of Controls" on page 9.) Re-insert the battery and try again. (See "Battery Installation" on page 5.)
The handset does not ring.	Ringer volume is set to "OFF".	Adjust the ringer volume level. (See "Adjusting the Ringer Volume" on page 15.)
You cannot make/receive a call.	The handset is out of range, or the CS is busy.	Move closer to the CS or try again later.
	The radio channel is busy, or a radio communication error occurred.	Try again later.
You cannot dial.	The number that you dialled is restricted by the PBX.	Consult your dealer.
	Key lock mode is on.	To cancel the mode, press  for about 2 seconds. (See "Key Lock" on page 11.)
	The radio channel is busy or a radio communication error occurred.	Try again later.
The handset stops working during operation.		<ul style="list-style-type: none"> Turn the handset off, then turn it back on. (See "Location of Controls" on page 9.) Re-insert the battery and try again. (See "Battery Installation" on page 5.)
You cannot use the handset during a power failure.	The handset will not function during a power failure because the PBX stops emitting radiowaves.	

Troubleshooting and Error Messages

Problem	Possible Cause	Solution
The headset does not work.	A headset tone cannot be heard when receiving an incoming call when the headset is attached.	<ul style="list-style-type: none"> Make sure the headset tone setting is set to "On". (See "Incoming Option" on page 64.) Make sure the headset jack is connected properly. (See "Location of Controls" on page 9.)
The tone from the headset cannot be changed to a bell or melody.	The headset tone is a specific tone and is not related to the Incoming Option settings (Ringer Type).	
Noise is frequently heard.		<ul style="list-style-type: none"> Place the handset and CS away from other electrical appliances. Move closer to the CS.
Two short beeps are heard during a conversation.	The radio signal is weak.	Move closer to the CS.
The charge indicator flashes red rapidly.	The charger is not connected properly.	<ul style="list-style-type: none"> Make sure the battery is inserted properly. Set the handset in the charger properly.
You charged the battery for 5.5 hours, but the beep tones sound, and  (needs to be charged) flashes after a few telephone calls.	The battery charge contacts may be dirty.	Clean the battery charge contacts without damaging them and charge once more.
	It is time to change the battery.	Replace with a new one.
While operating the handset, the AC adaptor feels warm. While charging the battery, the handset feels warm.	These are normal conditions.	
"No Service" is displayed, and beep tones are heard.	The handset is out of range.	Move closer to the CS or try again later.
	The CS or PBX is out of service.	Consult your dealer.

Error Messages

Error Message	Possible Cause	Solution
Register Unit	The handset has been cancelled or the handset has not been registered.	Consult your dealer.
No Service	The handset is out of range.	Move closer to the CS.
	The CS is turned off.	Make sure the power cord is connected.
PS Not Connected	The called handset is out of range or is not turned on.	Try again later.
CS Busy	The CS is busy.	Try again later.
Please Wait...	The handset is connecting to the CS or PBX.	Wait for a moment.
Charge Battery	The handset battery has little charge remaining.	Charge the battery fully. (See "Charging the Battery" on page 6.)
No Entries	When trying to view the Phonebook: No items have been stored. (See "Storing an Item in the Handset Phonebook" on page 45.) When trying to view the Incoming or Outgoing Call Log: No logs have been stored.	
Memory Full	The Phonebook is full and cannot store the new item.	Remove unnecessary data in the Phonebook and try again.
Incorrect Entry	The numbers you entered are invalid.	Recheck your entry (max. 5 digits) and try again.
Need Repair		Consult your dealer.

Battery Information

After your Panasonic battery is fully charged (at 25 °C):

Operation	Operating Time
While in use (Talk)	Up to about 15 h
While not in use (Standby)	Up to about 200 h

- Operating time may be shorter than listed above depending on usage conditions and ambient temperature.
- The battery will drain slowly even while the handset is turned off.
- The handset can receive calls while charging.
- Battery consumption increases when the handset is used out of range. If "▽" flashes, turn the handset off.
- **Clean the handset and the charger contacts with a soft, dry cloth once a month. Clean more often if the unit is subject to grease, dust or high humidity.** Otherwise the battery may not charge properly.

Low Battery Warning

The battery needs to be charged in the following situations:

- "□" flashes, and the alarm sounds*1.
- "Charge Battery" is displayed. In this situation, the handset cannot be operated.

*1 If the low battery warning occurs during a conversation, the call will be automatically disconnected one minute after the alarm sounds.

Replacing the Battery

If "□" flashes after using the phone for a short time, even when the battery has been fully charged, the battery should be replaced.

Before replacing the battery, make sure the low battery warning is displayed, then turn off the power to prevent memory loss. Replace the battery and charge the new battery for about 5.5 hours.

If you replace the battery before the low battery warnings appears, the battery strength icon may display an incorrect reading. In this case, use the handset as normal with the new battery installed. When the low battery warning is displayed, charge the battery for about 5.5 hours. The battery strength icon will then display the correct reading.

Important Information

1. Turn the power off to prevent memory loss.
2. Press the notch on the cover firmly and slide it as indicated by the arrow (❶).
3. Open the cover and replace the batteries.
 - Insert a finger into the side gap to remove the batteries easily (❷).
4. Close the cover and charge the handset.

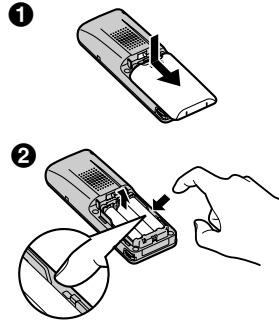

- Please use a Panasonic battery with the service part number HHR-4EPT only.

Important Safety Instructions

When using your telephone equipment, basic safety precautions, including those below, should always be followed to reduce the risk of fire, electric shock and injury to persons.

- Do not use the product near water, for example, near a bathtub, wash bowl, kitchen sink, or laundry tub, in a wet basement, or near a swimming pool.
- Do not use the telephone in the vicinity of a gas leak to report the leak.
- Do not mix old and new batteries.

SAVE THESE INSTRUCTIONS

For Your Safety

WARNING

- Do not install the product in any other way than described in relevant manuals.
- For safety reasons, do not physically modify the product or any optional equipment.
- The product may only be installed and serviced by qualified service personnel.
- To prevent possible fire or electric shock, do not expose this product to rain or moisture.
- Follow all warnings and instructions marked on this product.
- Do not place the product on an unstable surface, as a fall may cause serious internal damage.
- The AC adaptor only be connected to the type of electric power supply specified on the charger label. If you are not sure of the type of power supply to your home, consult your dealer or local power company.
- Do not allow anything to rest on the power cord. Do not locate the charger where the power cord may be stepped on or tripped on.
- To reduce the risk of electric shock, do not disassemble this product. Only qualified personnel should service this product. Opening or removing covers may expose you to dangerous voltages or other risks. Incorrect reassembly can cause electric shock.
- Unplug the charger from the AC outlet and have the product serviced by qualified service personnel in the following cases:
 - A. When the power supply cord or plug is damaged or frayed.
 - B. If liquid has been spilled into this product.
 - C. If the product has been exposed to rain or water.
 - D. If the product does not operate according to this manual. Adjust only the controls that are explained in this manual. Improper adjustment of other controls may result in damage and may require service by a qualified technician to restore the product to normal operation.
 - E. If the product has been dropped or damaged.
 - F. If product performance deteriorates.
- Do not insert objects of any kind into this product through openings, as they may touch dangerous voltage points or short out parts that could result in a risk of fire or electric shock. Never spill liquid of any kind on or in the product.

- The use of excessive sound volume through earphones, headphones, or headsets may cause hearing loss.
- Switch off the device when in the proximity of areas with potentially explosive atmospheres such as fuel/chemical storage facilities or blasting operations.
- Consult the manufacturer of any personal medical devices, such as pacemakers, to determine if they are adequately shielded from external RF (radio frequency) energy. (The product operates in the frequency range of 1880 MHz to 1900 MHz and the output peak power level is less than 0.25 W.)
- Do not use the product in health care facilities if any regulations posted in the area instruct you not to do so. Hospitals or health care facilities may be using devices sensitive to external RF (radio frequency) energy.
- Unplug the charger from AC outlet if it emits smoke, an abnormal smell or makes unusual noise. These conditions can cause fire or electric shock. Confirm that smoke has stopped and contact an authorised service centre.
- The batteries pose a choking hazard. Keep the batteries out of reach of children.
- This handset earpiece is magnetised and may retain small ferrous objects.

CAUTION

- Unplug the charger from the AC outlet before cleaning. Wipe the product with a soft cloth. Do not clean with abrasive powders or with chemical agents such as benzene or thinner. Do not use liquid cleaners or aerosol cleaners.
- When you operate this product, the AC outlet should be near the product and easily accessible.
- The product should never be placed near or over a radiator or other heat source.
- Use only the AC adaptor, battery and charger indicated in this manual.
- Do not dispose of the battery in a fire. They may explode. Check with local authorities for special disposal instructions.
- Do not open or disassemble the battery. Released electrolyte is corrosive and may cause burns or injury to the eyes or skin. The electrolyte is toxic if swallowed.
- Exercise care in handling batteries in order not to short the battery to conductive materials such as rings, bracelets, and keys. The battery and/or conductor may overheat and cause burns.
- Charge the battery provided with, or identified for use with, this product only in accordance with the instructions and limitations specified in this manual.
- There is a danger of explosion if the battery is incorrectly replaced.
- Do not place metal items such as coins or rings on the charger. As they become hot, you might get burnt if you touch them.

Note

This telephone communicates using digital signals that are difficult to intercept. However, it is possible that the signals could be intercepted by a third party.

Important Notice Concerning the Correct Use and Charging of Ni-MH Batteries

Batteries, due to their construction, undergo some wear and tear. The lifetime of a battery also depends on correct maintenance. Charging and discharging are the most important factors. You should take notice of the following to maintain the life of the battery as long as possible.

Ni-MH batteries have a kind of memory, the "memory effect". If fully charged batteries are used several times only for 15 minutes in the handset and then recharged, the capacity of the batteries will be reduced to 15 minutes due to the memory effect. Therefore you should discharge the batteries completely, i.e. use them in the handset until "" on the display starts flashing. Then recharge them as described in the manual. After the memory effect has occurred, it is possible to achieve almost complete capacity of the Ni-MH batteries by charging and discharging several times one after another.

Ni-MH batteries can also self-discharge. This self-discharge depends on the ambient temperature. At temperatures under 0 °C, the self-discharge will be the lowest. High humidity and high temperatures support the self-discharge. Also long-term storage will lead to self-discharge. A dead Ni-MH battery should not be disposed of normally. They contain toxic heavy metal hydride and therefore should be recycled.

CAUTION

**RISK OF EXPLOSION IF BATTERY IS REPLACED
BY AN INCORRECT TYPE.
DISPOSE OF USED BATTERIES ACCORDING
TO THE INSTRUCTIONS.**

For Best Performance

Operating Range

- The range of operation depends on the topography of your office, weather, or usage conditions, because signals are transmitted between the CS and the handset by radio waves.
- Normally, you get greater range outdoors than indoors. If there are obstacles such as walls, noise may interfere with your telephone calls. In particular, high metal shelves or reinforced concrete walls will restrict your operating range.
- A handset may not work when it is too far from the CS depending on the structure of the building.
- We strongly suggest you hold the bottom half of the handset to ensure better call quality. Because, the antenna is located in the upper half of the handset.

Noise

Occasional noise or interference may occur due to electromagnetic radiation from objects such as refrigerators, microwave ovens, faxes, TVs, radios, or personal computers. If noise disturbs your telephone calls, keep the handset away from these electrical appliances.

Environment

- Keep the product away from heating appliances and devices that generate electrical noise, such as fluorescent lamps and motors. These noise sources can interfere with performance of the product.
- Do not place the product in rooms where the temperature is less than 5 °C or greater than 40 °C.
- Allow 10 cm clearance around the product for proper ventilation.
- Avoid environments with excessive smoke, dust, moisture, mechanical vibration, shock, or direct sunlight.
- The apparatus is designed to be installed and operated under controlled conditions of ambient temperature and a relative humidity.

Routine Care

- Wipe the product with a soft cloth.
- Do not clean the product with abrasive powder or with chemical agents such as benzene or thinner.
- Clean the terminal of the charger periodically.
- When you leave the product unused for a long period of time, unplug the AC adaptor from the outlet.

Placement

- Do not place heavy objects on top of the handset and charger.
- Care should be taken so that objects do not fall onto, and liquids are not spilled into, the product. Do not subject the product to excessive smoke, dust, mechanical vibration, or shock.
- Place the charger on a flat surface. If the charger is mounted on the wall, install it straight.

Important Information

Notice for product repair, disposal, transfer, or return

- Keep a copy of all important data (such as your Phonebook) before sending the machine for repair.
- This product can store your private/confidential information. To protect your privacy/confidentiality, we recommend that you erase the information such as Phonebook or call log from the memory before you dispose, transfer or return the product.

IMPORTANT NOTICE

Under power failure conditions, this wireless telephone may not operate. Please ensure that a separate telephone, not dependent on local power, is available for emergency use in emergencies.

When a failure occurs which results in the internal parts becoming accessible, disconnect the AC adaptor immediately and return this unit to the place of purchase or service centre.

- This apparatus is designed to aid the visually handicapped to locate dial keys and buttons.
- 999 and 112 can be dialled on the apparatus after accessing the outside line for the purpose of making outgoing calls to the BT emergency (999) and (112) services.*¹
- This equipment shall not be set to make automatic calls to the Telecom '111' Emergency Service.*²

*¹ The regulation applied in the United Kingdom only.

*² The regulation applied in New Zealand only.

RF Specification

Item	Description
Radio Access Method	MultiCarrier TDMA-TDD
Frequency Band	1880 MHz to 1900 MHz
Number of Carriers	10
Carrier Spacing	1728 kHz
Bit Rate	1152 kbps
Carrier Multiplex	TDMA, 24 (Tx12, Rx12) slots per frame
Frame Length	10 ms
Modulation Scheme	GFSK Roll-off factor=0.5 50 % roll-off in the transmitter
Data Coding for Modulator	Differential Coding
Voice CODEC	32 kbps ADPCM (CCITT G.721)
Transmission Output	Average 10 mW Peak 250 mW

Important Information

System Requirements

This model supports the following CS models, PBX models, and PBX software versions:

CS	PBX	
	Model No.	Main Processing (MPR) Software Version
KX-TDA0141CE	KX-TDA30	PSMPR Software File Version 5.0000 or later
	KX-TDA100 KX-TDA200	PMPR Software File Version 5.0000 or later
	KX-TDA600	PLMPR Software File Version 5.0000 or later
	KX-TDE100 KX-TDE200	PMMPR Software File Version 1.0000 or later
	KX-TDE600	PGMPR Software File Version 2.0000 or later
	KX-NCP500 KX-NCP1000	PBMPR Software File Version 1.0000 or later
KX-TDA0142CE	KX-TDA100 KX-TDA200	PMPR Software File Version 5.0000 or later
	KX-TDA600	PLMPR Software File Version 5.0000 or later
	KX-TDE100 KX-TDE200	PMMPR Software File Version 1.0000 or later
	KX-TDE600	PGMPR Software File Version 2.0000 or later
KX-TDA0158CE	KX-TDA30	PSMPR Software File Version 5.0000 or later
	KX-TDA100 KX-TDA200	PMPR Software File Version 5.0000 or later
	KX-TDA600	PLMPR Software File Version 5.0000 or later
	KX-TDE100 KX-TDE200	PMMPR Software File Version 1.0000 or later
	KX-TDE600	PGMPR Software File Version 2.0000 or later
	KX-NCP500 KX-NCP1000	PBMPR Software File Version 1.0000 or later
KX-NCP0158CE	KX-NCP500 KX-NCP1000	PBMPR Software File Version 2.0000 or later

Additional Information

For Users in New Zealand only

PTC200 General Warning

1. The grant of a Telepermit for any item of terminal equipment indicates only that Telecom has accepted that the item complies with minimum conditions for connection to its network. It indicates no endorsement of the product by Telecom, nor does it provide any sort of warranty. Above all, it provides no assurance that any item will work correctly in all respects with another item of Telepermitted equipment of a different make or model, nor does it imply that any product is compatible with all of Telecom's network services.

PTC200 4.12 (2) (b) Handset Instability

2. When attached to some longer lines this Panasonic KX-TCA275 DECT Cordless Handset may display instability immediately after dialling if the handset is placed facedown on a hard surface. This is a temporary condition that will revert to a normal level after a short duration. Please do not report it to the Telecom Fault Service.

PTC200 6.11.1 (3) All Customer Equipment (fail safe requirements)

3. Under power failure conditions this appliance may not operate. Please ensure that a separate telephone, not dependent on local power, is available for emergency use.

For Users in Singapore only

Complies with
IDA Standards
DB 01017

For users in Hong Kong only



Information for Users on Collection and Disposal of Old Equipment and used Batteries

PDF Eraser Free



These symbols on the products, packaging, and/or accompanying documents mean that used electrical and electronic products and batteries should not be mixed with general household waste.

For proper treatment, recovery and recycling of old products and used batteries, please take them to applicable collection points, in accordance with your national legislation and the Directives 2002/96/EC and 2006/66/EC.

By disposing of these products and batteries correctly, you will help to save valuable resources and prevent any potential negative effects on human health and the environment which could otherwise arise from inappropriate waste handling.

For more information about collection and recycling of old products and batteries, please contact your local municipality, your waste disposal service or the point of sale where you purchased the items.

Penalties may be applicable for incorrect disposal of this waste, in accordance with national legislation.

For business users in the European Union

If you wish to discard electrical and electronic equipment, please contact your dealer or supplier for further information.



Information on Disposal in other Countries outside the European Union

These symbols are only valid in the European Union. If you wish to discard these items, please contact your local authorities or dealer and ask for the correct method of disposal.



Note for the battery symbol (bottom two symbol examples):

This symbol might be used in combination with a chemical symbol. In this case it complies with the requirement set by the Directive for the chemical involved.

The following declaration is applicable to KX-TCA275CE/KX-TCA275UK only

PDF Eraser Free
CE 1321

This device is a DECT Portable station operating in the frequency band of 1880 MHz to 1900 MHz.

The usage of this device is generally allowed in all EU countries.

Panasonic Communications Company (U.K.) Ltd. declares that this equipment is in compliance with the essential requirements and other relevant provisions of Radio & Telecommunications Terminal Equipment (R&TTE) Directive 1999/5/EC. Declarations of Conformity for the relevant Panasonic products described in this manual are available for download by visiting:

<http://www.doc.panasonic.de>

Contact to Authorised Representative:

Panasonic Testing Centre

Panasonic Marketing Europe GmbH

Winsbergring 15, 22525 Hamburg, Germany

PDF Eraser Free

Panasonic Communications Co., Ltd.

1-62, 4-chome, Minoshima, Hakata-ku, Fukuoka 812-8531, Japan

Copyright:

This material is copyrighted by Panasonic Communications Co., Ltd., and may be reproduced for internal use only. All other reproduction, in whole or in part, is prohibited without the written consent of Panasonic Communications Co., Ltd.

© Panasonic Communications Co., Ltd. 2009

PSQX4875WA KK0309YR2069 (CE/UK/AL)