



Panasonic

Advanced Hybrid System

Feature Guide



KX-TES824
Model KX-TEM824



Thank you for purchasing a Panasonic Advanced Hybrid System.
Please read this manual carefully before using this product and save this manual for future use.

KX-TES824/KX-TEM824: Version 3.0

Introduction

About this Feature Guide

The Feature Guide is designed to serve as an overall reference describing the features of the Panasonic Advanced Hybrid System.

It explains what the PBX can do, as well as how to obtain the most of its many features and facilities.

The Feature Guide is divided into the following sections:

Section 1, Call Handling Features

Describes the features of the PBX related to making and receiving calls, and operating telephones.

Section 2, System Configuration and Administration Features

Describes the features that allow the PBX to be configured and administered to suit the needs of its users.

Section 3, Programming Instructions

Serves as an overall system programming reference for the PBX.

Section 4, Appendix

Provides tables that describe the resource capacity of the PBX, as well as its different tones and ring tones.

References Found in the Feature Guide

Installation Manual References

The Installation Manual provides instructions detailing the installation and maintenance of the PBX. Sections from the Installation Manual are listed throughout the Feature Guide for your reference.

Feature Guide References

Related sections of the Feature Guide are listed for your reference.

User Manual References

The User Manual describes how users can access commonly used PBX features and functions with their proprietary telephones (PTs), single line telephones (SLTs), and Direct Station Selection (DSS) Consoles. Sections from the User Manual are listed throughout the Feature Guide for your reference.

PT Programming References

Commonly used settings can be programmed using a display PT (→ 2.3.2 PT Programming). These PT programming items are noted throughout the Feature Guide for your reference by title and programme number. The following is an example of a PT Programming reference:

"Idle extensions are automatically searched for according to a preprogrammed hunting type (→ Hunting Type [101])."

Links to Other Pages and Manuals

If you are viewing this Feature Guide with a PC, certain items are linked to different sections of the Feature Guide and other PBX manuals. Click on a link to jump to that section.

Linked items include:

- Installation Manual References
- Feature Guide References

-
- User Manual References
 - PT Programming References

Notes

- Certain PTs, features, and optional service cards are not available in some areas. Consult your certified Panasonic dealer for more information.
- Every system programming setting can be accessed using a PC and the Panasonic KX-TE Maintenance Console software (→ 2.3.1 PC Programming). For programming details, refer to the on-line help that is installed along with KX-TE Maintenance Console (→ 3.2.1 Installing and Starting KX-TE Maintenance Console).



The KX-TES824E, the KX-TES824NE, the KX-TES824GR, the KX-TES824CE/ KX-TEM824CE, and the KX-TES824PD/KX-TEM824PD are designed to interwork with the Analogue Public Switched Telephone Network (PSTN) of European countries.

Panasonic Communications Co., Ltd./Panasonic Communications Company (U.K.) Ltd. declares that this equipment is in compliance with the essential requirements and other relevant provisions of Radio & Telecommunications Terminal Equipment (R&TTE) Directive 1999/5/EC. Declarations of Conformity for the relevant Panasonic products described in this manual are available for download by visiting:

<http://www.doc.panasonic.de>

Contact:
Panasonic Services Europe
a Division of Panasonic Marketing Europe GmbH
Panasonic Testing Centre
Winsbergring 15, 22525 Hamburg, Germany

Trademarks

- Microsoft and Windows are either registered trademarks or trademarks of Microsoft Corporation in the United States and/or other countries.
- Intel and Celeron are trademarks or registered trademarks of Intel Corporation or its subsidiaries in the United States and other countries.
- All other trademarks identified herein are the property of their respective owners.

List of Abbreviations

A	AA	→	Automated Attendant
	APT	→	Analogue Proprietary Telephone
	ARS	→	Automatic Route Selection
B	BGM	→	Background Music
	BSS	→	Busy Station Signalling
	BV	→	Built-in Voice Message
C	COS	→	Class of Service
	CPC	→	Calling Party Control
D	DIL	→	Direct In Line
	DISA	→	Direct Inward System Access
	DND	→	Do Not Disturb
	DRD	→	Distinctive Ring Detection
	DSS	→	Direct Station Selection
	DTMF	→	Dual Tone Multi-Frequency
	E	EFA	→
F	FWD	→	Call Forwarding
G	G-CO	→	Group-CO
I	IRNA	→	Intercept Routing—No Answer
L	LCS	→	Live Call Screening
	LED	→	Light Emitting Diode
O	O-CO	→	Other-CO
	OGM	→	Outgoing Message
P	PF	→	Programmable Feature
	PSTN	→	Public Switched Telephone Network
	PT	→	Proprietary Telephone
S	S-CO	→	Single-CO
	SLT	→	Single Line Telephone
	SMDR	→	Station Message Detail Recording
	SMS	→	Short Message Service
T	TAM	→	Telephone Answering Machine
	TRS	→	Toll Restriction
U	UCD	→	Uniform Call Distribution
V	VM	→	Voice Mail
	VPS	→	Voice Processing System

Feature Highlights

Built-in Voice Message (BV) (Optional voice message card required)

Built-in Voice Message (BV) allows a caller to leave a voice message in a user's personal message area or the PBX's common message area (→ 1.15.7 Built-in Voice Message (BV)).

Fixed Line SMS Terminal Support (Optional Caller ID card required)

The PBX can relay incoming calls from a Short Message Service (SMS) centre to specific single line telephones (SLTs) that support SMS. Fixed Line SMS is a service that allows text messages to be sent and received via Public Switched Telephone Network (PSTN) access. We recommend using SMS-enabled Panasonic SLTs (→ 1.17.3 Fixed Line SMS Terminal Support).

Caller ID Display on SLT (Optional Caller ID card required)

The PBX can receive Caller ID information (telephone numbers and callers' names) from calls received on outside (CO) lines. This information can be shown on the displays of SLTs that support Caller ID as well as proprietary telephones (PTs) when receiving calls (→ 1.16.1 Caller ID).

3-level Automated Attendant (AA)

3-level Automated Attendant (AA) service allows a caller to dial a single-digit number (Direct Inward System Access [DISA] AA number) following the guidance of 3-level DISA outgoing messages (OGMs), and be connected to the desired party automatically (→ 1.15.6 Direct Inward System Access (DISA)).

Call Charge Calculation

The PBX can automatically calculate the approximate cost of calls and limit telephone usage to a preprogrammed budget on each extension. This feature allows users to calculate the cost of a call based on time, the leading digits of a phone number and/or the outside (CO) line carrying the call (→ 1.20.2 Call Charge Calculation).

Station Message Detail Recording (SMDR)

The PBX (with an optional message expansion card) can automatically log up to 10 000 incoming/outgoing outside (CO) line calls and 10 000 outgoing outside (CO) line calls for each extension. It is possible to log the Date, Time, Dial number, Duration and Charge of each call. The call logs can be output via the Serial Interface (RS-232C) port to a PC, printer, etc. (→ 1.20.1 Station Message Detail Recording Feature).

PC Programming

System programming settings can be accessed using a PC and the Panasonic KX-TE Maintenance Console software as well as by using a PT (→ 2.3.1 PC Programming).

The PBX software can be upgraded via the Serial Interface (RS-232C) port or USB port, using the KX-TE Maintenance Console software (→ 2.3.7 Firmware Upgrade).

Automatic Configuration for Outside (CO) Line Type

The dialling mode of connected outside (CO) lines is automatically configured the first time the PBX is accessed with a PC using the KX-TE Maintenance Console software, or after the PBX data has been cleared (→ 2.3.5 Automatic Configuration for Outside (CO) Line Type).

Advanced Hybrid System

This PBX supports the connection of PTs*1, Direct Station Selection (DSS) Consoles, and single line devices such as SLTs, fax machines, wireless telephones, and data terminals.

*1 In this manual, "proprietary telephone" ("PT") means an analogue proprietary telephone (APT).

Table of Contents

1	Call Handling Features	13
1.1	Incoming Call Features	14
1.1.1	Incoming Outside (CO) Line Call Features	14
1.1.1.1	Direct In Line (DIL)	14
1.1.1.2	Intercept Routing	15
1.1.2	Internal Call Features	16
1.1.3	Incoming Call Indication Features	17
1.1.3.1	Incoming Call Indication Features—OVERVIEW	17
1.1.3.2	Outside (CO) Line Ringing Selection	18
1.1.3.3	Ring Tone Pattern Selection	19
1.1.3.4	Distinctive Ring Detection (DRD) for New Zealand	20
1.1.3.5	Call Waiting	22
1.2	Receiving Group Features	23
1.2.1	Idle Extension Hunting	23
1.2.2	Uniform Call Distribution (UCD)	25
1.2.3	Direct Inward System Access (DISA) Ring	28
1.2.4	Log-in/Log-out	29
1.3	Call Forwarding (FWD)/Do Not Disturb (DND) Features	30
1.3.1	Call Forwarding (FWD)/Do Not Disturb (DND)	30
1.3.1.1	Call Forwarding (FWD)/Do Not Disturb (DND)—OVERVIEW	30
1.3.1.2	Call Forwarding (FWD)	31
1.3.1.3	Do Not Disturb (DND)	34
1.4	Answering Features	35
1.4.1	Answering Features	35
1.4.1.1	Answering Features—OVERVIEW	35
1.4.1.2	Line Preference—Incoming	36
1.4.1.3	Call Pickup	37
1.4.1.4	Hands-free Answerback	38
1.5	Making Call Features	39
1.5.1	Intercom Call Features	39
1.5.1.1	Intercom Call	39
1.5.2	Outside (CO) Line Call Features	41
1.5.2.1	Outside (CO) Line Call Features—OVERVIEW	41
1.5.2.2	Emergency Call	42
1.5.2.3	Account Code Entry	43
1.5.2.4	Dial Type Selection	44
1.5.2.5	Reverse Circuit	45
1.5.2.6	CO Busy Out	46
1.5.2.7	Pause Insertion	47
1.5.2.8	Host PBX Access Code (Access Code to the Telephone Company from a Host PBX)	48
1.5.3	Seizing a Line Features	50
1.5.3.1	Seizing a Line Features—OVERVIEW	50
1.5.3.2	Line Preference—Outgoing	51
1.5.3.3	Outside (CO) Line Access	52
1.6	Memory Dialling Features	54
1.6.1	Memory Dialling Features	54
1.6.1.1	Memory Dialling Features—OVERVIEW	54
1.6.1.2	One-touch Dialling	56
1.6.1.3	KX-T7710 One-touch Dialling	57
1.6.1.4	Redial	58
1.6.1.5	Speed Dialling—Personal/System	59
1.6.1.6	Quick Dialling	60

1.6.1.7	Hot Line	61
1.7	Busy Line/Busy Party Features.....	62
1.7.1	Automatic Callback Busy (Camp-on).....	62
1.7.2	Executive Busy Override	63
1.7.3	Call Waiting Tone.....	64
1.8	Toll Restriction (TRS) Features	65
1.8.1	Toll Restriction (TRS).....	65
1.8.2	Toll Restriction (TRS) Override by Account Code	69
1.8.3	Budget Management	71
1.8.4	Extension Lock	72
1.8.5	Walking COS	73
1.9	Automatic Route Selection (ARS) Features	74
1.9.1	Automatic Route Selection (ARS)	74
1.10	Conversation Features.....	80
1.10.1	Hands-free Operation	80
1.10.2	Room Monitor	81
1.10.3	Microphone Mute.....	82
1.10.4	Headset Operation	83
1.10.5	Data Line Security	84
1.10.6	Flash/Recall.....	85
1.10.7	External Feature Access (EFA)	86
1.10.8	Outside (CO) Line Call Limitation	87
1.10.9	Paralleled Telephone	88
1.10.10	Calling Party Control (CPC) Signal Detection	89
1.11	Transferring Features.....	90
1.11.1	Call Transfer.....	90
1.12	Holding Features	92
1.12.1	Call Hold.....	92
1.12.2	Call Park.....	94
1.12.3	Call Splitting.....	95
1.12.4	Music on Hold.....	96
1.12.5	Consultation Hold	97
1.13	Conference Features.....	98
1.13.1	Conference Features	98
1.13.1.1	Conference Features—OVERVIEW.....	98
1.13.1.2	Conference	99
1.14	Paging Features.....	101
1.14.1	Paging	101
1.15	Optional Device Features	102
1.15.1	Doorphone Call	102
1.15.2	Door Open	103
1.15.3	Doorbell/Door Chime	104
1.15.4	Background Music (BGM)	106
1.15.5	Outgoing Message (OGM) for DISA/UCD	107
1.15.6	Direct Inward System Access (DISA)	108
1.15.7	Built-in Voice Message (BV)	116
1.16	Caller ID Features	121
1.16.1	Caller ID.....	121
1.16.2	Incoming Call Log.....	125
1.17	Message Features	128
1.17.1	Message Waiting	128

1.17.2	Absent Message	130
1.17.3	Fixed Line SMS Terminal Support	131
1.18	Proprietary Telephone (PT) Features	135
1.18.1	Fixed Buttons	135
1.18.2	Flexible Buttons.....	137
1.18.3	LED Indication.....	139
1.18.4	Display Information.....	141
1.19	Voice Mail Features	143
1.19.1	Voice Mail APT Integration.....	143
1.19.2	Voice Mail Inband (DTMF) Integration.....	149
1.20	Administrative Information Features	152
1.20.1	Station Message Detail Recording Feature	152
1.20.1.1	Station Message Detail Recording (SMDR)	152
1.20.1.2	Call Log Printout for Each Extension.....	159
1.20.2	Call Charge Calculation	161
1.21	Extension Controlling Features.....	167
1.21.1	Extension Feature Clear	167
1.21.2	Timed Reminder.....	168
1.22	Audible Tone Features.....	169
1.22.1	Dial Tone	169
1.22.2	Confirmation Tone	170
2	System Configuration and Administration Features	171
2.1	System Configuration—Hardware.....	172
2.1.1	Extension Jack Configuration.....	172
2.2	System Configuration—Software	173
2.2.1	Class of Service (COS).....	173
2.2.2	Group	174
2.2.3	Time Service	176
2.2.4	Operator/Manager Features.....	179
2.3	System Data Control.....	182
2.3.1	PC Programming.....	182
2.3.2	PT Programming	184
2.3.3	Automatic Time Adjustment	186
2.3.4	Feature Numbering	187
2.3.5	Automatic Configuration for Outside (CO) Line Type	193
2.3.6	Country Setting	194
2.3.7	Firmware Upgrade	195
2.4	Fault Recovery/Diagnostics	196
2.4.1	Power Failure Transfer.....	196
2.4.2	Power Failure Restart.....	197
3	Programming Instructions.....	199
3.1	Introduction	200
3.1.1	Introduction	200
3.2	PC Programming.....	201
3.2.1	Installing and Starting KX-TE Maintenance Console	201
3.3	PT Programming	202
3.3.1	Programming Instructions	202
3.3.2	Programming Procedures	207
	Date & Time [000].....	207

System Speed Dialling Number [001].....	207
System Password [002].....	208
DSS Console Jack Assignment [003].....	209
Console Paired Telephone [004].....	209
One-touch Transfer Using a DSS Button [005].....	209
Time Service Switching Mode [006].....	210
Time Service Start Time [007].....	210
Operator Assignment [008].....	210
Extension Number [009].....	211
LCD Time Display [010].....	211
System Speed Dialling Name [011].....	212
Second Feature Numbering Plan [012].....	212
KX-T7710 One-touch Dialling [013].....	213
Hunting Group Set [100].....	213
Hunting Type [101].....	213
DTMF Integration Port [102].....	214
DTMF Integration [103].....	214
SLT Hold Mode [104].....	214
Conference Tone [105].....	214
External Pager Access Tone [106].....	215
DTMF Receiver Check [107].....	215
Flash/Recall Mode for a Locked Extension [108].....	215
CO Indicator [109].....	215
Flash/Recall Key Mode [110].....	216
Music on Hold [111].....	216
DSS Lamp Mode [112].....	216
Automatic Redial Repeat Count [113].....	216
Automatic Redial Interval [114].....	217
Extension Ring Tone Pattern [115].....	217
Conference Pattern [116].....	217
Call Pickup Tone [117].....	217
Pulse Restriction [118].....	218
Redialling after Pulse to Tone Conversion [119].....	218
Bell Frequency [120].....	218
Automatic Line Access [121].....	218
Automatic Rotation for CO Line Access [122].....	218
Break Ratio [123].....	219
TRS Check for * and # [125].....	219
DSS Off-hook Mode [126].....	219
Pickup Group [127].....	219
Ringback Tone Pattern [128].....	220
VM 1 APT Port [130].....	220
VM 2 APT Port [131].....	220
SLT Ring/Silence Ratio [142].....	221
SLT Ring Bell-on Time [143].....	221
SMS Centre Number for Receiving [145].....	221
SMS Routing Table—CO [146].....	221
SMS Routing Table—Extension [147].....	222
SLT Caller ID Signalling Type [150].....	222
SLT Caller ID Line Access Number [151].....	222
Automatic Time Adjustment [152].....	222
Incoming Reverse [153].....	223
CO Busy Out [154].....	223
CO Busy Out Check Time [155].....	223
Call Charge Calculation—Registering Leading Numbers [161].....	223
Call Charge Calculation—Time Table 1/2/3/4 [162/169/176/183].....	224
Call Charge Table 1/2/3/4—Peak Flat Charge and Duration [163/170/177/184].....	224
Call Charge Table 1/2/3/4—Peak Unit Charge and Duration [164/171/178/185].....	225
Call Charge Table 1/2/3/4—Off Peak Flat Charge and Duration [165/172/179/186].....	225
Call Charge Table 1/2/3/4—Off Peak Unit Charge and Duration [166/173/180/187].....	225

Call Charge Table 1/2/3/4—Economy Flat Charge and Duration [167/174/181/188]	226
Call Charge Table 1/2/3/4—Economy Unit Charge and Duration [168/175/182/189].....	226
Decimal Places [190].....	226
Hold Recall Time [200]	226
Transfer Recall Time [201].....	227
Call Forwarding Start Time [202].....	227
Hot Line Waiting Time [203]	227
Call Duration Counter Start [204]	227
CO-to-CO Line Call Duration [205].....	227
Dialling Start Time [206].....	228
Hookswitch Flash Timing Range [207]	228
Inter-digit Time [208].....	228
DTMF Time [210].....	228
No Dial Disconnection [211]	229
Extension-to-CO Line Call Duration [212]	229
Bell-off Detection [213]	229
BV Recording Time [214]	229
Common/Personal BV OGM Recording Time [215]	229
Carrier Exception Code [300]	230
TRS—System Speed Dialling Class [301].....	230
TRS—COS 2-5 Denied Code [302-305].....	230
TRS—Exception Code [306]	230
Emergency Number [309].....	231
Account Code [310].....	231
Automatic Pause Insertion Code [311]	231
TRS—Extension Lock Class [312]	232
ARS Selection [350]	232
Route 1-4 Selection Code [351-354]	232
Route 1-4 Exception Code [355-358]	232
1st Carrier Selection Code [359]	233
ARS Modification—Removed Digits [360]	233
ARS Modification—Added Number [361]	233
ARS Dial Tone [362]	233
ARS Inter-digit Time [363]	234
ARS CO Line Group [364].....	234
Route 1-4 Authorisation Code [381-384].....	234
Route 1-4 Itemised Billing [385-388]	235
Itemised Billing Code [389].....	235
Authorisation and Itemised Billing Code Order [390].....	235
CO Line Connection [400]	236
Dial Mode [401]	236
Pulse Speed [402].....	237
Host PBX Access Code [403].....	237
CO Line Group Number [404].....	238
Flexible Outward Dialling—Day/Night/Lunch [405-407].....	238
Flexible Ringing—Day/Night/Lunch [408-410].....	239
Delayed Ringing—Day/Night/Lunch [411-413].....	239
CO Line Mode—Day/Night/Lunch [414-416]	240
Pause Time [417]	241
Flash/Recall Time [418].....	241
Automatic Designated Line Access [419]	242
CPC Signal Detection—Incoming [420].....	242
CPC Signal Detection—Outgoing [421].....	242
Disconnect Time [422].....	243
CO Line Ring Tone Pattern [423].....	243
Polarity Reverse Detection [424]	244
Collect Call Block [425] (Brazil only).....	244
Distinctive Ring Detection (DRD) [426] (New Zealand only)	244
DRD Ring Pattern 2 Extension Assignment—Day/Night/Lunch [427-429] (New Zealand only).....	245
DRD Ring Pattern 3 Extension Assignment—Day/Night/Lunch [430-432] (New Zealand only).....	245

DRD Pattern 2 and 3 Ring Tone [433-434] (New Zealand only)	246
DISA IRNA to BV—Day/Night/Lunch [438-440]	246
Call Charge Calculation [441]	246
Call Charge Table Assignment [442]	247
DISA Incoming Call Dial Mode [500]	247
DISA Built-in AA [501]	247
FAX Connection [503]	248
DISA Delayed Answer Time [504]	248
DISA Wait Time after OGM [505]	248
DISA Busy Mode [506]	248
DISA Intercept Mode [507]	248
DISA Ring Time before Intercept [508]	249
DISA Ring Time after Intercept [509]	249
DISA No Dial Mode [510]	249
DISA Security Mode [511]	249
DISA Security Code [512]	250
Cyclic Tone Detection [513]	250
FAX Tone Detection [514]	251
Intercept Time for Internal DISA [515]	251
DISA Incoming Assignment [516]	251
DISA AA Wait Time [517]	251
DISA Tone after Security Code [518]	251
OGM Mute Time [519]	252
UCD Group [520]	252
UCD Busy Waiting Time [521]	252
UCD OGM Message Interval Time [522]	252
UCD Busy Mode [523]	252
UCD Intercept Mode [524]	253
UCD Ring Time before Intercept [525]	253
UCD Ring Time after Intercept [526]	253
UCD Waiting Message [527]	253
DISA Security Code Digits [530]	253
DISA Ringback Tone [531]	254
3-level AA Assignment [540-549]	254
Clear All OGMs of DISA/UCD [599]	254
Extension Group [600]	255
TRS-COS—Day/Night/Lunch [601-603]	255
Extension Name [604]	255
Account Code Mode [605]	256
Call Transfer to CO Line [606]	256
Call Forwarding to CO Line [607]	256
Executive Busy Override [608]	257
DND Override [609]	257
Paralleled Telephone [610]	257
TAM Extension [611]	258
Room Monitor [612]	258
CO Line Call Duration Limitation [613]	258
Internal Pulse Detection [614]	259
LCD Language [615]	259
Extension Name in Cyrillic [616]	259
Message Waiting for Another Extension [618]	260
SLT Message Waiting [619]	260
LCS Recording Mode Set [620]	261
BV Resource [621]	261
BV for Extension [622]	261
BV Access Code through CO Line [625]	262
BGM Control for APT [626]	262
SLT Ring Wait Time for New Call [627]	262
SLT Caller ID [628]	263
SLT Fixed Bell Pattern [629]	263

LCD Display Mode [630].....	263
Doorphone Ringing—Day/Night/Lunch [700-702]	264
Door Opener—Day/Night/Lunch [703-705]	264
Doorphone Ring Tone Pattern [706]	265
Doorphone Access Tone [707]	265
Doorphone Ring Time [708]	266
Door Open Duration [709]	266
Doorphone Ring/Chime [710].....	266
Doorphone Chime Assignment [711]	267
Doorphone Chime Pattern [712].....	267
SMDR RS-232C Parameter [800].....	268
SMDR Parameter [801]	268
Incoming/Outgoing Call Selection for Printing [802].....	269
Secret Number SMDR Print Suppression [803]	269
System Data Dump [804]	269
SMDR Account Code [805]	270
SMDR Language [806].....	270
BV Total Recording Time [807].....	270
BV Card Initialisation [808]	271
Caller ID [900].....	271
Caller ID Area Code [901]	271
Caller ID Modification for Local Calls [902].....	272
Caller ID Modification for Long-distance Calls [903].....	272
Caller ID Log Priority [904]	272
Caller ID Automatic 0 Addition [905].....	273
Caller ID SMDR Format [906].....	273
Caller ID SMDR Printout [907]	273
Common Area Call Log Check [909]	273
Caller ID Type [910].....	274
Currency [921].....	274
Call Charge Information SMDR Format 1 [922].....	274
Call Charge Information SMDR Format 2 [923].....	274
Secret Printing [924].....	275
Budget Management [925]	275
Budget Limit Selection [926].....	275
Call Log Next Page [927]	275
SMDR Mode for Printing [929]	276
Call Forwarding Selection [963].....	276
TRS Check after Answering [966]	276
TRS Check Time after Answering [967]	277
KX-T7700 Series Incoming Lamp Control [968].....	277
Country [995].....	277
Firmware Version [998].....	277
System Data Clear [999]	278
4 Appendix	279
4.1 Capacity of System Resources.....	280
4.1.1 Capacity of System Resources	280
4.2 Tones/Ring Tones.....	282
4.2.1 Tones/Ring Tones.....	282
4.3 Revision History.....	288
4.3.1 Version 2.0	288
Index	291

Section 1

Call Handling Features

1.1 Incoming Call Features

1.1.1 Incoming Outside (CO) Line Call Features

1.1.1.1 Direct In Line (DIL)

Description

Directs incoming outside (CO) line calls to a preprogrammed destination based on the outside (CO) line carrying the call. Each outside (CO) line can have a different destination for each time service mode.

[Programming Example]

The table can be programmed for each outside (CO) line.

Outside (CO) Line No.	Distribution method and destination*					
	Day		Lunch		Night	
1	DIL	101	DIL	102	DIL	102
2	DIL	103	DIL	103	DIL	103
(Cont.) :	:	:	:	:	:	:
:	:	:	:	:	:	:
8	Normal	–	Normal	–	Normal	–

* → CO Line Mode—Day/Night/Lunch [414-416]

In this example:

If an outside (CO) line call is received on outside (CO) line 1:

- a) In day mode: Direct In Line (DIL) distribution is assigned. The call is routed to its DIL destination, extension 101.
- b) In lunch/night mode: DIL distribution is assigned. The call is routed to its DIL destination, extension 102.

Conditions

- To use this feature, "DIL" must be selected as the distribution method for the desired outside (CO) line port. When "Normal" is selected, an incoming outside (CO) line call is received at the extensions assigned in Flexible Ringing—Day/Night/Lunch [408-410].
- This outside (CO) line can be used by multiple extension users to make calls, but can only be used by a single extension to receive calls.
- If a DIL destination is an extension within an extension group that has enabled the Idle Extension Hunting feature and it is busy, the Idle Extension Hunting feature becomes active (→ 1.2.1 Idle Extension Hunting).

Feature Guide References

2.2.3 Time Service

1.1.1.2 Intercept Routing

Description

Redirects incoming outside (CO) line calls via the Direct Inward System Access (DISA) or Uniform Call Distribution (UCD) feature to a preprogrammed destination when the original destination does not, or cannot, answer the call. There are 2 types of Intercept Routing, described below.

Type	Description
No Dial	While or after hearing a DISA outgoing message (OGM) or after hearing a dial tone (short beep), if the caller does not dial anything or enters an unrecognised input, the call is redirected to preprogrammed intercept destinations in the following priority: DISA IRNA to BV—Day/Night/Lunch [438-440] → Flexible Ringing—Day/Night/Lunch [408-410]
Intercept Routing—No Answer (IRNA)	If a called party does not answer a call within a preprogrammed time period (→ DISA Ring Time before Intercept [508], UCD Ring Time before Intercept [525]), the call is redirected to preprogrammed intercept destinations in the following priority: DISA IRNA to BV—Day/Night/Lunch [438-440] → Flexible Ringing—Day/Night/Lunch [408-410]

Feature Guide References

- 1.2.2 Uniform Call Distribution (UCD)
- 1.15.6 Direct Inward System Access (DISA)
- 1.15.7 Built-in Voice Message (BV)

1.1.2 Internal Call Features

Description

There are 2 types of internal calls, described below.

Feature	Description	Details in
Intercom Call	A call from one extension to another.	• 1.5.1.1 Intercom Call
Doorphone Call	A call made from a doorphone to its preprogrammed destination for the current time service mode, assigned to the doorphone's port (→ 2.2.3 Time Service).	• 1.15.1 Doorphone Call

1.1.3 Incoming Call Indication Features

1.1.3.1 Incoming Call Indication Features—OVERVIEW

Description

Extension telephones can indicate an incoming call in various ways, described below.

Indication Type	Feature	Description	Details in
Ring/No Ring	Outside (CO) Line Ringing Selection	Each extension can be programmed to ring or not ring when receiving an outside (CO) line call.	• 1.1.3.2 Outside (CO) Line Ringing Selection
Ring Tone	Ring Tone Pattern Selection	A telephone rings when receiving a call. A different ring tone pattern can be assigned to each incoming call type.	• 1.1.3.3 Ring Tone Pattern Selection
Voice-calling	Alternate Receiving—Ring/Voice	Proprietary telephone (PT) users can choose how their telephones receive intercom calls, by selecting to hear ring tones or the caller's voice.	• 1.5.1.1 Intercom Call
LED (Light Emitting Diode)	LED Indication	The LED indicators on a PT can indicate the status of different lines using light patterns and colours.	• 1.18.3 LED Indication
Display (Caller Information)	Display Information	A user's PT can show a variety of information on the display, such as the outside (CO) line number, the caller's name and number, the extension number and name of the calling extension after the call is forwarded, etc.	• 1.18.4 Display Information
Tone During a Conversation	Call Waiting	When an extension user is in the middle of a call, the user can be alerted to a new call by a call waiting tone.	• 1.1.3.5 Call Waiting

1.1.3.2 Outside (CO) Line Ringing Selection

Description

An extension user can select whether the telephone will ring or not when receiving call(s) from assigned or all outside (CO) lines through personal programming.

Conditions

- System programming determines which extension(s) will ring for incoming outside (CO) line calls in each time service mode (→ Flexible Ringing—Day/Night/Lunch [408-410]).
- If an outside (CO) line call reaches a user's extension, but the extension is set to not ring, the CO button will flash. The outside (CO) line call can be answered by pressing the flashing CO button.

User Manual References

3.1.2 Changing Personal Settings Using Programming Mode

1.1.3.3 Ring Tone Pattern Selection

Description

A different ring tone pattern can be assigned to each incoming call type, such as intercom calls (→ Extension Ring Tone Pattern [115]), calls from each doorphone (→ Doorphone Ring Tone Pattern [706]), and calls from each outside (CO) line (→ CO Line Ring Tone Pattern [423]).

Available ring tone patterns are as follows:

[Ring Tone Patterns]

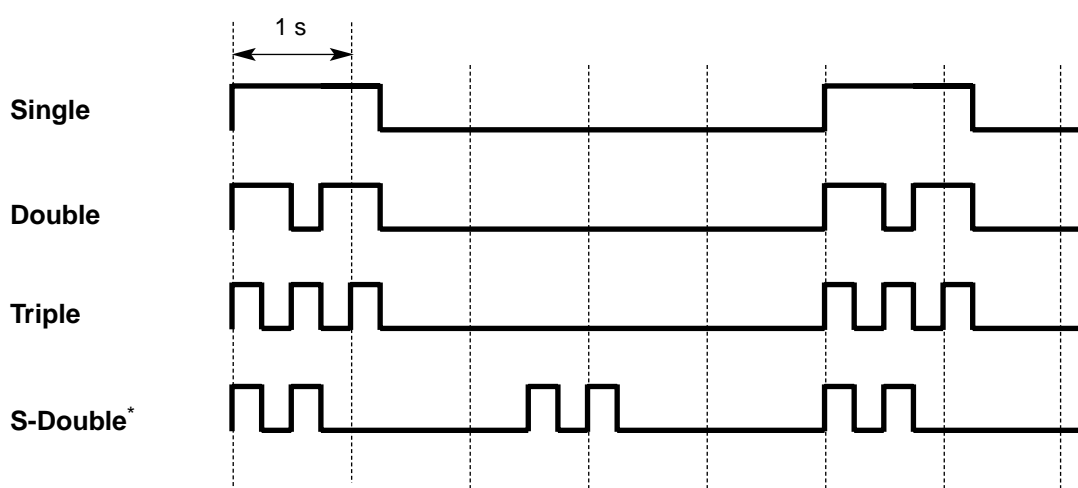

* S-Double is available for doorphone calls only.

Conditions

- The ring tone pattern for incoming calls (intercom calls and outside (CO) line calls) to a single line telephone (SLT) can be fixed to "Single" or "Double" for each extension through system programming (→ SLT Fixed Bell Pattern [629]). The length of the ring tone pattern depends on the preprogrammed length of the bell-on signal (→ SLT Ring Bell-on Time [143]), combined with the ratio between the bell signals of the SLT (→ SLT Ring/Silence Ratio [142]). Depending on the type of SLT being used, the SLT may not ring properly, if the ring tone pattern of the SLT is set differently from that used by the telephone company.

Feature Guide References

- 1.1.3.2 Outside (CO) Line Ringing Selection
- 4.2.1 Tones/Ring Tones

1.1.3.4 Distinctive Ring Detection (DRD) for New Zealand

Description

Distinctive Ring Detection (DRD) is only available in New Zealand.

The PBX can detect the following 4 ring tone patterns sent from the telephone company for each outside (CO) line. When the PBX detects one of the ring tone patterns, the call will be transferred to the preprogrammed destination(s) automatically according to system programming. In addition, the extension ring tone pattern for the detected call can be assigned through system programming as shown below.

[Ring Tone Patterns Sent from the Telephone Company]

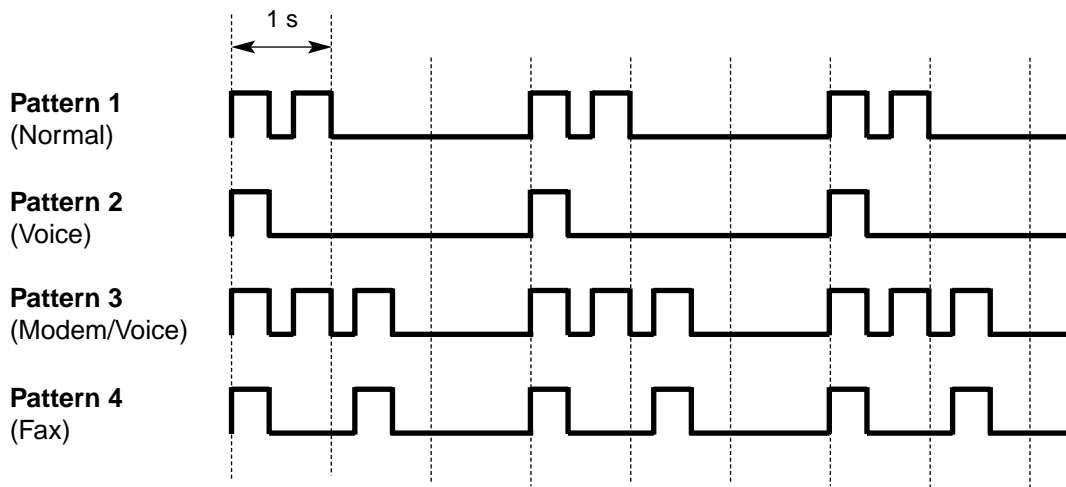

Pattern	Destination assigned in	Ring Tone Pattern assigned in
1	Flexible Ringing—Day/Night/Lunch [408-410], or sent to the Direct Inward System Access (DISA) line or Uniform Call Distribution (UCD) group	CO Line Ring Tone Pattern [423]
2	DRD Ring Pattern 2 Extension Assignment—Day/Night/Lunch [427-429] (New Zealand only)	DRD Pattern 2 and 3 Ring Tone [433-434] (New Zealand only)
3	DRD Ring Pattern 3 Extension Assignment—Day/Night/Lunch [430-432] (New Zealand only)	DRD Pattern 2 and 3 Ring Tone [433-434] (New Zealand only)
4	FAX Connection [503]	CO Line Ring Tone Pattern [423]

Conditions

- To use this feature, "UCD", "DISA", or "Normal" must be selected as the distribution method for the desired outside (CO) line port (→ CO Line Mode—Day/Night/Lunch [414-416]) and DRD must be enabled (→ Distinctive Ring Detection (DRD) [426] (New Zealand only)).

Feature Guide References

1.2.2 Uniform Call Distribution (UCD)

1.15.6 Direct Inward System Access (DISA)

4.2.1 Tones/Ring Tones

1.1.3.5 Call Waiting

Description

A busy extension user can be alerted to a new call by Call Waiting. The busy extension user can then answer the second call either by disconnecting the current call or placing it on hold.

If Call Waiting is enabled, a call waiting tone will be sent to the user under the following conditions:

- a) When an outside (CO) line call or a doorphone call is received, or
- b) When another extension executes the Busy Station Signalling (BSS) feature.

If disabled, a reorder tone will be sent to the extension that executed the BSS feature.

Call Waiting from the Telephone Company

Besides the Call Waiting feature provided by the PBX, you can also subscribe to your telephone company's Call Waiting service and receive call waiting tones through the telephone company's lines. This feature is available when an extension is in a conversation with an outside party, and a call is received from another outside party on the same outside (CO) line. The external call waiting tone will alert an extension user of the incoming outside (CO) line call that is waiting. The user can answer the second call by disconnecting the current call or placing it on hold. If a call waiting tone is heard but the corresponding CO button does not flash, this tone is an external call waiting tone from the telephone company. For details, consult your telephone company.

Conditions

- **Data Line Security**
When an extension user activates Data Line Security, Call Waiting is turned off (→ 1.10.5 Data Line Security).
- **Call Waiting Tone**
A proprietary telephone (PT) user can select the preferred call waiting tone through personal programming (Call Waiting Tone Type Selection).
- **Caller ID Information**
When an extension receives a call waiting tone, the caller's information will flash on the display for 5 seconds at 15-second intervals.

Feature Guide References

- 1.7.3 Call Waiting Tone
- 4.2.1 Tones/Ring Tones

User Manual References

- 1.2.4 When the Dialed Party is Busy or There is No Answer
- 1.4.4 Answering Call Waiting
- 1.7.3 Receiving Call Waiting
- 3.1.2 Changing Personal Settings Using Programming Mode

1.2 Receiving Group Features

1.2.1 Idle Extension Hunting

Description

If a called extension is busy, Idle Extension Hunting redirects the call to an idle member of the same extension group, if that group has been assigned as an idle extension hunting group through system programming (→ Hunting Group Set [100]). Idle extensions are automatically searched for according to a preprogrammed hunting type (→ Hunting Type [101]).

This feature is also known as Station Hunting.

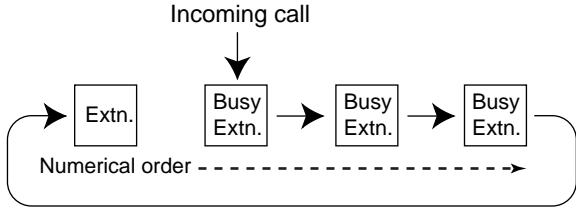
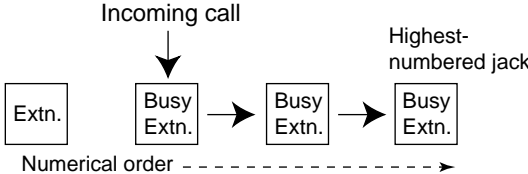
Type	Description
Circular Hunting	<p>An idle extension is searched for in a circular fashion one time according to the numerical order of the jacks.</p> 
Terminated Hunting	<p>An idle extension is searched for in the numerical order of the jacks, until reaching the extension that is connected to the highest-numbered jack in the group.</p> 

Conditions

- **Idle Extension Hunting applies to:**
Intercom calls and outside (CO) line calls directed to a single extension.
- An extension can belong to only one extension group (→ Extension Group [600]). One hunting type can be programmed for each extension group.
- If all the searched extensions in an idle extension hunting group are busy, a busy tone will be heard at the extension that made the intercom call (including Direct Inward System Access [DISA] calls).
- A user can leave an idle extension hunting group temporarily by logging out of the group, and rejoin the group by logging back in (→ 1.2.4 Log-in/Log-out).
- **FWD/DND Mode**
When searching for an idle extension within an idle extension hunting group, any extension that has set FWD, DND, or Log-out will be skipped (→ 1.3.1 Call Forwarding (FWD)/Do Not Disturb (DND)). However, if the extension that receives the call first has set FWD or DND, Idle Extension Hunting will

1.2 Receiving Group Features

not function and the call will be forwarded to the preprogrammed destination (when FWD is set) or will not be received at all (when DND is set).

- **Message Waiting**

A message waiting indication will not be sent to an idle extension hunting destination.

The MESSAGE button light or Message/Ringer Lamp turns on at the original destination only (→ 1.17.1 Message Waiting).

Feature Guide References

2.2.2 Group

[Flowchart]

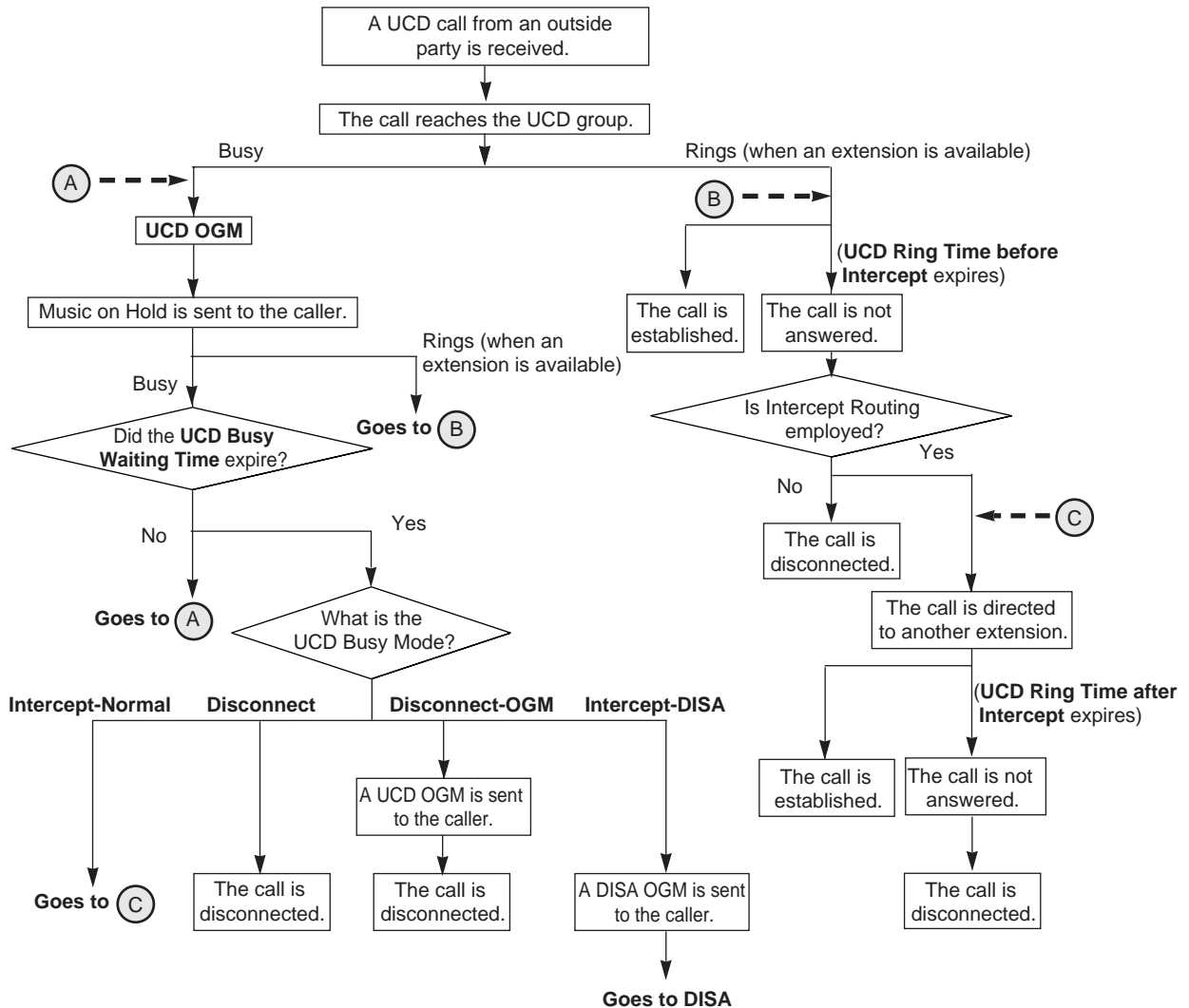

UCD Busy Mode

When all extensions in a UCD group are busy, a call will wait for a preprogrammed length of time (→ UCD Busy Waiting Time [521]). If this timer expires, the PBX will handle the call in one of the following ways according to system programming (→ UCD Busy Mode [523]):

- a) **Disconnect:** The call is disconnected immediately.
- b) **Disconnect-OGM:** The call is disconnected after a UCD outgoing message (OGM) plays (e.g., "We are still handling other calls. Please call back later.").
- c) **Intercept-Normal:** The call is directed to preprogrammed destinations (→ Flexible Ringing—Day/Night/Lunch [408-410]).
- d) **Intercept-DISA:** The call is directed to the DISA feature (→ 1.15.6 Direct Inward System Access (DISA)) and the caller hears a DISA OGM (e.g., "Thank you for calling Company A. Press 1 to speak to Sales. Press 2 to speak to Support.").

UCD Intercept Mode

When extensions in a UCD group are available but do not answer an outside (CO) line call within a preprogrammed length of time (→ UCD Ring Time before Intercept [525]), the PBX will handle the call in one of the following ways according to system programming (→ UCD Intercept Mode [524]):

- a) **Disconnect:** The call is disconnected. If a UCD OGM is not played, the call will not be disconnected until the caller goes on-hook.
- b) **Intercept:** The call is directed to preprogrammed destinations (→ Flexible Ringing—Day/Night/Lunch [408-410]). The extensions that receive the redirected call ring for a preprogrammed time period (→ UCD Ring Time after Intercept [526]). When the timer expires, the call is disconnected. If a UCD OGM is not played, the call will not be disconnected until the caller goes on-hook.

Conditions

- To use this feature, "UCD" must be selected as the distribution method for the desired outside (CO) line port (→ CO Line Mode—Day/Night/Lunch [414-416]).
- **UCD OGM**
It is possible to select the UCD OGM sent to the caller when a call arrives at a UCD group and all extensions in the group are busy (→ UCD Waiting Message [527]).
- The Log-in or Log-out status can be set for each extension (→ 1.2.4 Log-in/Log-out). The last member of a group cannot log out.
- **FWD/DND Mode**
When searching for an available extension, any extension that has set FWD—All Calls, FWD—Busy/No Answer, or DND will be skipped (→ 1.3.1 Call Forwarding (FWD)/Do Not Disturb (DND)).
- **UCD Busy Waiting Time**
It is possible to assign the length of time (→ UCD Busy Waiting Time [521]) the PBX holds an incoming outside (CO) line call via the UCD feature when all extensions in the UCD group are busy, and to assign the interval time between the repeated UCD OGMs (→ UCD OGM Message Interval Time [522]).

Feature Guide References

- 1.1.1.2 Intercept Routing
- 1.12.4 Music on Hold
- 2.2.2 Group

1.2.3 Direct Inward System Access (DISA) Ring

Description

A Direct Inward System Access (DISA) ring group is a specific extension group that receives DISA calls directed to the group. All extensions in the DISA ring group assigned as an Automated Attendant (AA) destination (→ DISA Built-in AA [501]) ring simultaneously.

Delayed Ringing

Each extension can be programmed for Delayed Ringing (→ Delayed Ringing—Day/Night/Lunch [411-413]), which allows extensions to be alerted to calls by flashing buttons only. Received calls can be answered by pressing the flashing button even if the extension is not ringing.

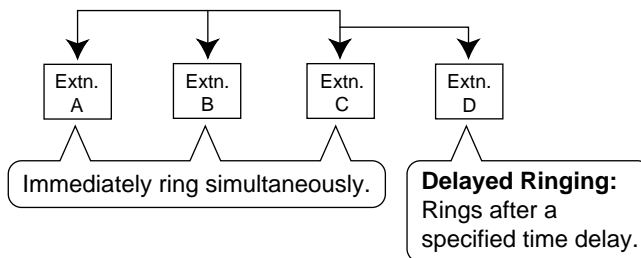

Conditions

- To use this feature, "DISA" must be selected as the distribution method for the desired outside (CO) line port (→ CO Line Mode—Day/Night/Lunch [414-416]), and DISA AA service must be assigned as the destination of incoming outside (CO) line calls via the DISA feature (→ DISA Incoming Call Dial Mode [500]).
- The Log-in or Log-out status can be set for each extension (→ 1.2.4 Log-in/Log-out). The last member of a group cannot log out.
- The Delayed Ringing feature does not apply to DISA or Direct In Line (DIL) calls. If the destination is a DISA ring group, this feature will function.

Feature Guide References

- 1.15.6 Direct Inward System Access (DISA)
- 2.2.2 Group

1.2.4 Log-in/Log-out

Description

Members of an idle extension hunting group, Direct Inward System Access (DISA) ring group, or Uniform Call Distribution (UCD) group can join (Log-in) or leave (Log-out) groups manually. Group members can log in at the beginning of a work shift when they are ready to answer calls, and log out at the end of the work shift.

Conditions

- The last member of a group cannot log out.
- While logged out from a group, a member extension will not receive calls to that group via the DISA, UCD, or Idle Extension Hunting features.
- **Log-in/Log-out Button**
A flexible CO button can be customised as a Log-in/Log-out button. It shows the current status as follows:

Light Pattern	Status
Red on	Logged out
Off	Logged in

Feature Guide References

- 1.2.1 Idle Extension Hunting
- 1.2.2 Uniform Call Distribution (UCD)
- 1.2.3 Direct Inward System Access (DISA) Ring
- 1.18.2 Flexible Buttons

User Manual References

- 1.5.4 Leaving a Group (Log-in/Log-out)

1.3 Call Forwarding (FWD)/Do Not Disturb (DND) Features

1.3.1 Call Forwarding (FWD)/Do Not Disturb (DND)

1.3.1.1 Call Forwarding (FWD)/Do Not Disturb (DND)—OVERVIEW

Description

When an extension user cannot answer calls (is on a call, out of the office, etc.), it is possible to forward or refuse calls directed to that extension using the following features:

1. Call Forwarding (FWD)
2. Do Not Disturb (DND)

1. FWD

Extension users can forward their incoming calls to preset destinations (→ 1.3.1.2 Call Forwarding (FWD)).

2. DND

An extension user can send a DND tone to let the caller know that he or she is not available (→ 1.3.1.3 Do Not Disturb (DND)).

Conditions

- **FWD/DND Button**

If a proprietary telephone (PT) does not have an FWD/DND button, a flexible CO button can be customised as an FWD/DND button.

[Button Status]

The FWD/DND button shows the current status as follows:

Light Pattern	Status
Red on	DND on
Slow red flashing	FWD on
Off	FWD/DND off

- Setting a new FWD mode, such as All Calls or Busy/No Answer, or the DND feature, clears the status of the previous FWD mode or DND feature.

Feature Guide References

1.18.1 Fixed Buttons

1.18.2 Flexible Buttons

1.3.1.2 Call Forwarding (FWD)

Description

Extension users can forward their calls to preset destinations. There are 4 Call Forwarding (FWD) modes, described below.

Mode	Description
All Calls	All calls are forwarded to another extension.
Busy/No Answer	All calls are forwarded to another extension when the extension user's line is busy, or when the user does not answer within a preprogrammed time period (→ Call Forwarding Start Time [202]).
To Outside (CO) Line	All calls are forwarded to an outside party, provided this feature is enabled for each extension through system programming (→ Call Forwarding to CO Line [607]).
Follow Me	When an extension user fails to set this feature before leaving his or her desk, this feature can be set from the destination extension.

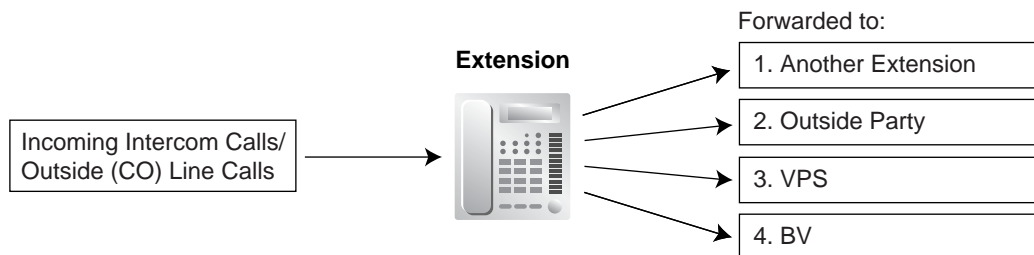

[Available Destinations]

Destination	Availability
Extension (proprietary telephone [PT]/single line telephone [SLT])	–
Automatic Line Access no. + Phone no.	Only available when FWD to Outside (CO) Line is enabled for the extension through system programming (→ Call Forwarding to CO Line [607]).
Outside (CO) Line Group Access no. + Outside (CO) Line Group no. + Phone no.	Only available when FWD to Outside (CO) Line is enabled for the extension through system programming (→ Call Forwarding to CO Line [607]).
Voice Processing System (VPS)	–
Built-in Voice Message (BV) feature no.	Only available when the BV feature is enabled for the extension through system programming (→ BV for Extension [622]).

Conditions

[General]

- This feature does not apply to calls from Hold Recall, Camp-on Recall, and Timed Reminder.

1.3 Call Forwarding (FWD)/Do Not Disturb (DND) Features

- The types of calls that are forwarded by this feature are:

Call Type	
Outside (CO) line calls	Normal except for FWD to Outside (CO) Line; Direct In Line (DIL); Direct Inward System Access (DISA)
Intercom calls	Extension, Transfer

- Uniform Call Distribution (UCD)**

When searching for an available extension within a UCD group, any extension that has set FWD will be skipped. However, if the last extension that can receive a call has set FWD, the call will be forwarded to that extension's call forwarding destination. The last member of a UCD group cannot log out.

- When a call is forwarded, the corresponding message waiting indication is not forwarded. The MESSAGE button light or Message/Ringer Lamp turns on only at the originally called extension (→ 1.17.1 Message Waiting).
- It is programmable whether the calls received on outside (CO) lines programmed as "Normal" (→ CO Line Mode—Day/Night/Lunch [414-416]) are forwarded for each extension or not (→ Call Forwarding Selection [963]). If FWD is enabled for an extension whose FWD destination is a VPS or Telephone Answering Machine (TAM) and the extension has been assigned to ring with other extensions, the VPS or TAM may answer the call before other extensions can answer it. To prevent this, disable FWD.
- A call can only be automatically forwarded one time. In the example below, extension A's calls are being forwarded to extension B. If extension B tries to set FWD to extension C, the extension B user hears a reorder tone and the setting is denied. If extension B has already set FWD to extension C, and extension A tries to set FWD to extension B, the setting is also denied.

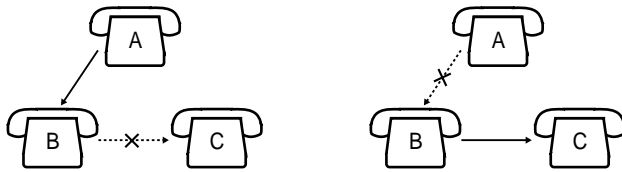

- The destination of an extension's forwarded calls can call or transfer calls to the original extension.

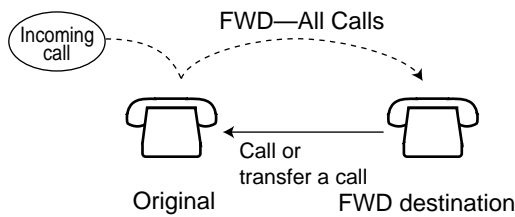

[Busy/No Answer]

- No Answer Time**

The length of time before calls are forwarded is programmable (→ Call Forwarding Start Time [202]).

[To Outside (CO) Line]

- FWD to Outside (CO) Line**

System programming determines the extensions that can forward all intercom calls and certain outside (CO) line calls to an outside party (→ Call Forwarding to CO Line [607]). These outside (CO) line calls must arrive on outside (CO) lines whose programming (→ CO Line Mode—Day/Night/Lunch [414-416]) is one of the following:

- DIL

- b)** DISA (only when the call is directly sent to an extension, not intercepted)
- c)** UCD (when only one member belongs to the group)
- **Outside (CO) Line Call Duration**

If a call between 2 outside parties is established, the call duration will be restricted by a system timer (→ CO-to-CO Line Call Duration [205]). Both parties will hear a warning tone 15 seconds before the timer expires. When the timer expires, the call is disconnected (→ 1.10.8 Outside (CO) Line Call Limitation).
- If a CPC (Calling Party Control) signal or reverse signal is received from an outside (CO) line, the corresponding call between 2 outside parties will be disconnected.

User Manual References

- 1.5.1 Forwarding Your Calls (Call Forwarding [FWD])
- 1.5.5 Using Voice Messaging (Built-in Voice Message [BV])
- 1.8.3 If a Voice Processing System is Connected

1.3.1.3 Do Not Disturb (DND)

Description

Extension users can use this feature to prevent calls from ringing at their extension. The calling extension will hear a Do Not Disturb (DND) tone.

Conditions

- **DND Override**
An extension in DND mode can be called by extensions that are allowed to override DND through system programming (→ DND Override [609]).
- This feature does not apply to calls from Hold Recall, Camp-on Recall, and Timed Reminder.
- Calls from outside (CO) lines programmed as "Normal" or "DIL" (→ CO Line Mode—Day/Night/Lunch [414-416]) can be received at a user's extension, but the telephone will not ring. The corresponding CO button will flash when an outside (CO) line call is received, and the user can answer the call by pressing this button.

User Manual References

- 1.2.4 When the Dialed Party is Busy or There is No Answer
- 1.7.2 Refusing Incoming Calls (Do Not Disturb [DND])

1.4 Answering Features

1.4.1 Answering Features

1.4.1.1 Answering Features—OVERVIEW

Description

An extension user can answer incoming calls using the following methods:

Called Extension	Feature	Description	Details in
A user's own extension (proprietary telephone [PT])	Line Preference—Incoming	A user can select the method to answer incoming calls.	• 1.4.1.2 Line Preference—Incoming
	Direct One-touch Answering	A user can answer an incoming call simply by pressing the flashing CO or INTERCOM button.	—
	Hands-free Answerback	A user can answer calls automatically and establish a hands-free conversation.	• 1.4.1.4 Hands-free Answerback
A user's own extension (single line telephone [SLT])	Receiving Calls	A user can answer an incoming call simply by going off-hook.	—
Another extension	Call Pickup	A user can pick up a call to a specific extension, a call within the user's extension group, or a call received by a Telephone Answering Machine (TAM) extension.	• 1.4.1.3 Call Pickup

1.4.1.2 Line Preference—Incoming

Description

A proprietary telephone (PT) user can select the method used to answer incoming calls from the following 3 line preferences.

Each of these line preferences can be selected by each extension through personal programming (Line Preference—Incoming).

Type	Description
No Line	A user can select a line by pressing the desired Outside (CO) Line Access button to answer an incoming call after going off-hook.
Prime Line	A user can answer a call arriving at a flexible CO button (assigned as the "Prime Line") simply by going off-hook.
Ringling Line (default)	A user can answer a call ringing at one's own telephone simply by going off-hook.

Conditions

- Ringing methods can be selected from among immediate, delayed, no ringing, or no incoming calls (disable) through system programming (→ Flexible Ringing—Day/Night/Lunch [408-410], Delayed Ringing—Day/Night/Lunch [411-413]).
- A single line telephone (SLT) user can select "Ringling Line" mode only.
- A flexible CO button should be assigned as an Outside (CO) Line Access button (Single-CO [S-CO], Group-CO [G-CO] or Other-CO [O-CO]) before selecting a line preference.
- Setting a new line preference clears the previous line preference.
- In "Prime Line" mode, if a PT user receives an incoming call on a line other than the "Prime Line", the user must go off-hook and then press the corresponding flashing CO button to answer the call.

User Manual References

3.1.2 Changing Personal Settings Using Programming Mode

1.4.1.3 Call Pickup

Description

An extension user can answer a call ringing at another extension by entering the appropriate feature numbers.

The following types of Call Pickup are available:

Type	Description
Directed Call Pickup	A call to a specific extension is answered.
Group Call Pickup	A call to an extension in the same extension group (→ Extension Group [600]) is answered.
Call Retrieving from a Telephone Answering Machine (TAM)	A call received by a preprogrammed TAM extension (→ TAM Extension [611]) is answered.

Call Pickup Deny

An extension user can prevent other extensions from picking up calls ringing at his or her own extension. If this feature is enabled, other users will hear a reorder tone when trying to pick up calls.

Conditions

[Directed/Group Call Pickup]

- **Call Pickup applies to:**
Intercom calls, outside (CO) line calls, and doorphone calls.
- An extension user will hear a confirmation tone when he or she picks up the call with the Directed Call Pickup or Group Call Pickup feature. It is possible to eliminate the tone through system programming (→ Call Pickup Tone [117]).
- Calls from Hold Recall and Camp-on Recall cannot be picked up with the Directed/Group Call Pickup feature.

[Group Call Pickup]

- By setting system programming (→ Pickup Group [127]) in advance, an extension user can pick up a call to another extension in the same extension group simply by going off-hook, even if his or her extension is not ringing.

User Manual References

1.3.3 Answering a Call Ringing at Another Telephone (Call Pickup)

1.4.1.4 Hands-free Answerback

Description

A user with a speakerphone-equipped proprietary telephone (PT) can answer intercom calls automatically without lifting the handset. When a call is received at an extension that is in Hands-free Answerback mode, the caller hears a confirmation tone and the called extension hears a beep tone. Then the conversation is automatically established.

Conditions

- **Hands-free Answerback applies to:**
Intercom calls (not including outside (CO) line calls or doorphone calls)
- When an intercom call/outside (CO) line call is transferred to an extension, this feature is overridden and a ring tone is heard.

Feature Guide References

1.5.1.1 Intercom Call

User Manual References

1.3.2 Answering Hands-free (Hands-free Answerback)

1.5 Making Call Features

1.5.1 Intercom Call Features

1.5.1.1 Intercom Call

Description

An extension user can call another extension user.

Conditions

- Extension Number/Name Assignment**
 Extension numbers (→ Extension Number [009]) and names (→ Extension Name [604], Extension Name in Cyrillic [616]) can be assigned to all extensions. During intercom calls, the number and name of the other extension are shown on the displays of proprietary telephones (PTs).
- DSS Button**
 It is possible to call another extension simply by pressing the corresponding Direct Station Selection (DSS) button (→ DSS Off-hook Mode [126]). A flexible CO/DSS/MESSAGE button can be customised as a DSS button.
 The DSS buttons on a DSS Console can also be used.
- Alternate Receiving—Ring/Voice**
 A PT user can select to receive intercom calls by ring tone or by voice, through personal programming (Alternate Receiving—Ring/Voice). If a user selects voice-calling, the calling party can talk to the user immediately after hearing a confirmation tone.
- Alternate Calling—Ring/Voice**
 A caller can change the called party's preset call receiving method (ring tone or voice). By doing so, ring-calling is switched to voice-calling, or vice versa, at the called party. This setting is active for the current call only, after which it reverts to the called party's previous setting.
- The extension ring tone pattern for incoming intercom calls can be selected through system programming (→ Extension Ring Tone Pattern [115]). The ringback tone pattern for outgoing intercom calls and for incoming outside (CO) line calls can also be selected through system programming (→ Ringback Tone Pattern [128]).
- Tone after Dialling**
 After dialling an extension number, a user will hear one of the following:

Type	Description
Ringback Tone	Indicates the call is being received at the called party's extension.
Confirmation Tone	Indicates the called party has set voice-calling.
Busy Tone	Indicates the called party's extension is busy.
DND Tone	Indicates the called party has set Do Not Disturb (DND).

Feature Guide References

- 1.18.2 Flexible Buttons
- 4.2.1 Tones/Ring Tones

User Manual References

1.2.1 Basic Calling

1.2.5 Switching the Calling Method (Alternate Calling—Ring/Voice)

3.1.2 Changing Personal Settings Using Programming Mode

1.5.2 Outside (CO) Line Call Features

1.5.2.1 Outside (CO) Line Call Features—OVERVIEW

Description

An extension user can use the following features when making an outside (CO) line call:

Feature	Description	Details in
Emergency Call	A user can dial preprogrammed emergency numbers regardless of the restrictions imposed on the extension.	• 1.5.2.2 Emergency Call
Account Code Entry	A user can enter an account code to identify outgoing calls for accounting and billing purposes.	• 1.5.2.3 Account Code Entry
Pulse to Tone Conversion	A user can temporarily switch from Pulse mode to DTMF (Dual Tone Multi-Frequency) mode if necessary.	• 1.5.2.4 Dial Type Selection
Pause Insertion	A dialling pause can be manually inserted by pressing the PAUSE button, or can be automatically inserted after a user-dialled code, such as a Host PBX Access code or Automatic Pause Insertion code. The length of the pause can be specified through system programming.	• 1.5.2.7 Pause Insertion • 1.5.2.8 Host PBX Access Code (Access Code to the Telephone Company from a Host PBX)

1.5.2.2 Emergency Call

Description

An extension user can dial preprogrammed emergency numbers (→ Emergency Number [309]) after seizing an outside (CO) line regardless of the restrictions imposed on the extension.

Conditions

- If the PBX is installed behind an existing host PBX, an extension user must dial the Host PBX Access code after the Outside (CO) Line Access number.
- This feature will function even when:
 - In Account Code—Verify-All/Verify-Toll/Forced mode (→ 1.5.2.3 Account Code Entry)
 - Restricted by the current class of service (COS) (→ 1.8.1 Toll Restriction (TRS))
 - The total of call charges has reached a specified budget limit (→ 1.8.3 Budget Management)
 - In Extension Lock (→ 1.8.4 Extension Lock)

1.5.2.3 Account Code Entry

Description

An account code is used to identify outgoing outside (CO) line calls for accounting and billing purposes. Account codes are appended to SMDR call records (→ 1.20.1 Station Message Detail Recording Feature), and have several uses. For example, a firm can use an account code for each client to determine which calls were made for which client, and can submit a bill to the client according to the client's account code as shown on the SMDR call record.

There are 4 methods of entering account codes, explained below. One method is assigned to each extension through system programming (→ Account Code Mode [605]).

Mode	Description
Option	An extension user can (but is not required to) enter a 4-digit account code during a conversation or within 30 seconds after a conversation ends when a record is needed.
Forced	An extension user must always enter a 4-digit account code within 5 seconds after seizing an outside (CO) line. This method ensures that extension users will not forget to enter account codes.
Verify-All	An extension user must always enter a preprogrammed account code (→ Account Code [310]) within 5 seconds after seizing an outside (CO) line. If the entered code does not match any preprogrammed code, the user will hear a reorder tone.
Verify-Toll	An extension user can enter a preprogrammed account code (→ Account Code [310]) within 5 seconds after seizing an outside (CO) line to override TRS (→ 1.8.2 Toll Restriction (TRS) Override by Account Code). Classes of service (COSs) 3 through 5 will be changed temporarily to COS 2. COSs 1 and 2 will not be affected. If the entered account code is also registered as an extension password, the extension password feature will be given priority. The COS of the corresponding extension will be applied.

Conditions

- An account code can be stored in Memory Dialling (One-touch Dialling, Hot Line, Speed Dialling—System/Personal, Call Forwarding (FWD) to Outside (CO) Line, etc.). In this case, the Account Code feature number and specified account code must be entered after the Outside (CO) Line Access number.
- An extension user does not need to enter an account code for incoming outside (CO) line calls.
- Even in Forced/Verify-All/Verify-Toll mode, emergency calls can be made without an account code (→ 1.5.2.2 Emergency Call).

User Manual References

1.2.1 Basic Calling

1.5.2.4 Dial Type Selection

Description

The dialling mode can be selected for each outside (CO) line through system programming (→ Dial Mode [401]) regardless of the originating extension (dependent on the contract with the telephone company).

Mode	Description
DTMF (Dual Tone Multi-Frequency)	Numbers dialled by an extension user are transmitted to the outside (CO) line using tones. If this PBX is installed behind an existing host PBX, select this mode as necessary. If your telephone company or a host PBX can receive both DTMF and Pulse signals but the contract specifies DTMF lines, select this mode.
Pulse (Rotary)	Numbers dialled by an extension user are transmitted to the outside (CO) line using pulses.
Call Blocking	If your telephone company or a host PBX can receive both DTMF and Pulse signals but the contract specifies Pulse lines, select this mode. When dialling with a touch-tone telephone, only Pulse signals will be sent to the telephone company.

Conditions

- **Automatic Configuration for Outside (CO) Line Type***
The dialling mode of connected outside (CO) lines is automatically assigned after restarting the PBX using the System Clear Switch or through system programming (→ System Data Clear [999]). No system programming in Dial Mode [401] and Pulse Speed [402] is required unless the dialling mode of the connected outside (CO) lines is Call Blocking. If your telephone company can receive both DTMF and Pulse signals, the PBX selects an outside (CO) line type according to the following priority:
DTMF → Pulse (High) → Pulse (Low)
- **Pulse to Tone Conversion***
It is possible for an extension user to temporarily switch from Pulse mode to DTMF mode in order to access special services such as computer-accessed long-distance calling or voice mail services. To switch to DTMF mode, wait for a preprogrammed time period after the outside (CO) line is connected, or press the "*#" key. This feature functions only on outside (CO) lines set to "Pulse" or "Call Block" mode (→ Dial Mode [401]). DTMF mode cannot be changed to Pulse mode.
- The pulse rate for outside (CO) lines that have been set to "Pulse" or "Call Block" mode (→ Dial Mode [401]) should be selected depending on your telephone company or a host PBX. There are 2 pulse rates: Low (10 pps) and High (20 pps) (→ Pulse Speed [402]).
- It is possible to assign the minimum duration of the DTMF signal sent to outside (CO) lines that have been set to "DTMF" mode (→ DTMF Time [210]).
- It is programmable whether DTMF dialling is sent to the telephone company when an extension user redials after changing from Pulse mode to DTMF mode by pressing the "*#" key (→ Redialling after Pulse to Tone Conversion [119]).
- * These features are not available for the AL (Australia) model.

User Manual References

1.4.9 Changing the Dialling Mode (Pulse to Tone Conversion)

1.5.2.5 Reverse Circuit

Description

The PBX can detect the reverse signal sent from the telephone company when an extension user tries to make an outside (CO) line call. This detects the start (the called party goes off-hook) and end (the called party goes on-hook) of an outgoing outside (CO) line call. The duration of the call can be verified with SMDR using this feature (→ 1.20.1 Station Message Detail Recording Feature).

This feature is also known as Polarity Reverse Detection.

Conditions

- If Reverse Signal Detection is enabled for an outside (CO) line (→ Polarity Reverse Detection [424]), the PBX will start the call duration counter (→ Call Duration Counter Start [204]) immediately after the outside party answers the call.

1.5.2.6 CO Busy Out

Description

The PBX can monitor the loop current sent through outside (CO) lines, preventing users from seizing lines where a loop current is not detected. When loop currents are not detected, outside (CO) lines are set to Busy Out status, and cannot be used to make calls (→ CO Busy Out [154]). An outside (CO) line in Busy Out status cannot be selected for making a call by Automatic Line Access or Outside (CO) Line Group Access, or by using the Other-CO (O-CO) button. If a user tries to seize an outside (CO) line set to Busy Out status, the user will hear a reorder tone and a message is shown on the display of the Proprietary Telephone (PT).

This is useful if some or all outside (CO) lines are occasionally unavailable because of problems with the external telecommunications environment.

Conditions

- Loop current detection is performed on active outside (CO) lines whenever the line is seized and/or at a preprogrammed time every day.
- By performing loop current detection at a preprogrammed time every day (→ CO Busy Out Check Time [155]), or pressing the corresponding Single-CO (S-CO) button on a PT, an outside (CO) line can be returned to in-service status once a loop current is detected. Also, selecting "Disable" in CO Busy Out [154] returns all outside (CO) lines to in-service status.
- Incoming calls can be received on outside (CO) lines set to Busy Out status. In this case, Busy Out status is cleared.
- Busy Out status is maintained even when the PBX is restarted.

1.5.2.7 Pause Insertion

Description

A dialling pause of a preprogrammed length can be inserted manually or automatically when dialling.

Manual Pause Insertion: A pause can be manually inserted by pressing the PAUSE button.

Automatic Pause Insertion: A pause will be automatically inserted after the user dials any one of the following numbers:

- a) Outside (CO) Line Access number
- b) Automatic Pause Insertion code
- c) Host PBX Access code (→ 1.5.2.8 Host PBX Access Code (Access Code to the Telephone Company from a Host PBX))

Conditions

- The pause length is programmable for each outside (CO) line (→ Pause Time [417]).
- When a dialled telephone number matches one of the Automatic Pause Insertion codes assigned through system programming (→ Automatic Pause Insertion Code [311]), a pause will be automatically inserted after the code. This is particularly convenient if a second dial tone is sent from your telephone company.
- This feature functions for Speed Dialling, One-touch Dialling, Last Number Redial, Saved Number Redial, Hot Line, and Call Forwarding (FWD)—To Outside (CO) Line, as well as for normal calls.

1.5.2.8 Host PBX Access Code (Access Code to the Telephone Company from a Host PBX)

Description

This PBX can be installed behind an existing host PBX. This is performed by connecting extension jacks of the host PBX to outside (CO) line ports of this PBX. A Host PBX Access code, assigned through system programming (→ Host PBX Access Code [403]), is required to access the telephone company from the host PBX. The Outside (CO) Line Access number (9/0*1, or 81 through 88) of the host PBX should be stored as a Host PBX Access code for each outside (CO) line of this PBX. A pause of a preprogrammed length (→ Pause Time [417]) will be automatically inserted after the user-dialed Host PBX Access code.

[Example]

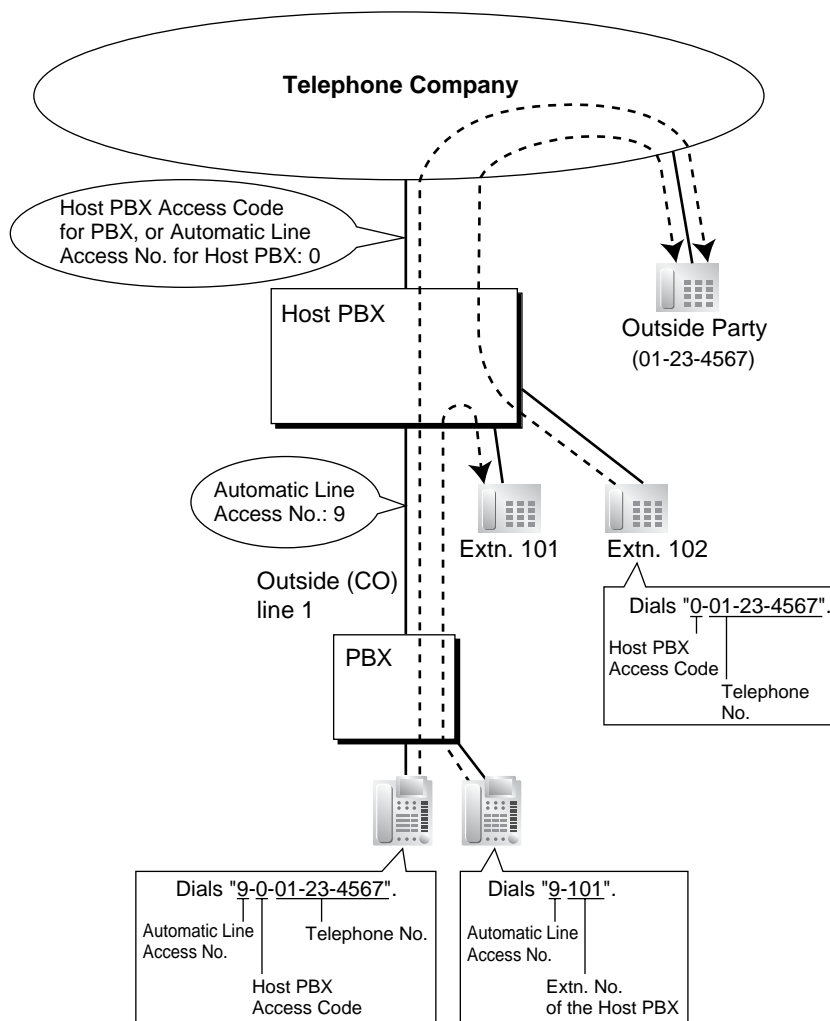

Note

In this example, "0" should be assigned as the Host PBX Access code for outside (CO) line 1 of this PBX.

*1 For New Zealand, the Automatic Line Access number may be either 1 or 9.

Conditions

- Access to the host PBX during a conversation is also possible (→ 1.10.7 External Feature Access (EFA)).
- **TRS**
TRS checks only the dialled telephone number, excluding the Host PBX Access code, when accessing the telephone company through the host PBX (→ 1.8.1 Toll Restriction (TRS)).
- **SMDR**
The Host PBX Access code can be logged by SMDR along with the dialled number when accessing the telephone company through the host PBX (→ 1.20.1 Station Message Detail Recording Feature).

1.5.3 Seizing a Line Features

1.5.3.1 Seizing a Line Features—OVERVIEW

Description

A proprietary telephone (PT) user can select the line that is seized in order to make a call, using one of the following features:

Feature	Description	Details in
Line Preference—Outgoing	A user can select the line to be seized when going off-hook.	• 1.5.3.2 Line Preference—Outgoing
Outside (CO) Line Access	A user can select the Outside (CO) Line Access method used when making outside (CO) line calls.	• 1.5.3.3 Outside (CO) Line Access

1.5.3.2 Line Preference—Outgoing

Description

Through personal programming, a proprietary telephone (PT) user can select the preferred method of seizing a line (Line Preference—Outgoing) to be used each time the user goes off-hook.

Method	Description
Idle Line	When a user goes off-hook, an idle outside (CO) line is selected automatically from among the assigned outside (CO) lines (→ Automatic Designated Line Access [419]).
No Line	When a user goes off-hook, no line is selected. In order to make a call, the user must select the desired line manually.
Prime Line	When a user goes off-hook, the preset line is selected automatically.

Conditions

- A flexible CO button should be assigned as an Outside (CO) Line Access button (Single-CO [S-CO], Group-CO [G-CO], or Other-CO [O-CO]) before selecting a line preference.
- Setting a new line preference clears the previous line preference.
- **Line Preference Override**
A user can override the preset line preference temporarily by pressing the desired Outside (CO) Line Access button or INTERCOM button before going off-hook.
- System programming determines the extension users that can make outside (CO) line calls in each time service mode (→ Flexible Outward Dialling—Day/Night/Lunch [405-407]).
- It is possible to specify which outside (CO) lines are connected to the PBX (→ CO Line Connection [400]). This prevents extension users from trying to select or making calls using outside (CO) lines that are not connected.

User Manual References

3.1.2 Changing Personal Settings Using Programming Mode

1.5.3.3 Outside (CO) Line Access

Description

There are 3 methods of accessing an outside (CO) line.

Method	Description	Operation
Automatic Line Access (Local Access)	Selects an idle outside (CO) line automatically from the assigned outside (CO) lines (→ Automatic Designated Line Access [419]). If Idle Line Preference (→ 1.5.3.2 Line Preference—Outgoing) is set on the extension through personal programming, the user can access an idle line simply by going off-hook.	Dial the Automatic Line Access number (9/0)* (→ Automatic Line Access [121]). Note * For New Zealand, the Automatic Line Access number may be either 1 or 9.
Outside (CO) Line Group Access	Selects an idle outside (CO) line from the corresponding outside (CO) line group.	Dial the Outside (CO) Line Group Access number and an outside (CO) line group number, or press a Group-CO (G-CO) button.
S-CO Line Access	Selects the desired outside (CO) line directly.	Press the Single-CO (S-CO) button.

Line Access Using the Other-CO (O-CO) Button

To select an idle outside (CO) line from among the outside (CO) lines that are not assigned to S-CO or G-CO buttons, the proprietary telephone (PT) user can press the O-CO button.

Conditions

- The PBX waits for a preprogrammed length of time (→ Dialling Start Time [206]) after seizing an outside (CO) line before dialling.
- Button Assignment**

A flexible CO button can be customised as an S-CO, G-CO, or O-CO button as follows:

Type	Assignable parameter
Single-CO (S-CO)	A specified outside (CO) line is assigned (Default: CO 1–CO 8).
Group-CO (G-CO)	An outside (CO) line group is assigned (→ CO Line Group Number [404]).
Other-CO (O-CO)	Outside (CO) lines that are not assigned to S-CO or G-CO buttons are assigned.

The same outside (CO) line group can be assigned to more than one G-CO button on the same PT. The same outside (CO) line can be assigned to an S-CO button and a G-CO button. Dialling the Outside (CO) Line Access number selects a CO button according to the following priority:
S-CO → G-CO → O-CO

Once a flexible CO button is assigned as an Outside (CO) Line Access button, it indicates line status with a variety of light patterns (→ 1.18.3 LED Indication).

- Direct Outside (CO) Line Access**

If a PT user is on-hook when pressing an idle CO button, the PT automatically enables hands-free

operation mode. The user can dial without lifting the handset or pressing the SP-PHONE or MONITOR button.

- **Outside (CO) Line Hunting Order for Automatic Line Access**
The outside (CO) line hunting sequence (from highest-numbered outside (CO) line, or in rotation) for Automatic Line Access can be determined through system programming (→ Automatic Rotation for CO Line Access [122]).
- System programming determines the extension users that can make outside (CO) line calls in each time service mode (→ Flexible Outward Dialling—Day/Night/Lunch [405-407]).
- It is possible to specify which outside (CO) lines are connected to the PBX (→ CO Line Connection [400]). This prevents extension users from trying to select or making calls using outside (CO) lines that are not connected.

Feature Guide References

1.18.2 Flexible Buttons

User Manual References

1.2.1 Basic Calling

1.6 Memory Dialling Features

1.6.1 Memory Dialling Features

1.6.1.1 Memory Dialling Features—OVERVIEW

Description

An extension user can store frequently dialled numbers in the PBX. A stored number can be dialled by a simple operation.

1. Features

Feature		Storage Method	Details in
One-touch Dialling		Personal Programming	• 1.6.1.2 One-touch Dialling
KX-T7710 One-touch Dialling		System Programming	• 1.6.1.3 KX-T7710 One-touch Dialling
Redial	Last Number	The last or most recently dialled number is automatically stored.	• 1.6.1.4 Redial
	Saved Number	While in a conversation with an outside party or while hearing a busy tone, the current telephone number can be manually stored and redialled afterwards.	
Speed Dialling	Personal	Personal Programming with the Feature Number	• 1.6.1.5 Speed Dialling—Personal/System
	System	System Programming	
Quick Dialling		System Programming	• 1.6.1.6 Quick Dialling
Hot Line		Personal Programming with the Feature Number	• 1.6.1.7 Hot Line
Incoming Call Log		Caller ID information is automatically stored.	• 1.16.2 Incoming Call Log

2. Valid Input

Input	Displayed while Entering	Description
0–9/*/#	0–9/*/#	Store digits, *, and # by pressing the corresponding buttons.
PAUSE (Pause)	P	Store a dialling pause by pressing the PAUSE button (→ 1.5.2.7 Pause Insertion).

Input	Displayed while Entering	Description
FLASH/RECALL (Hooking)* ¹	F	Store an EFA signal (EFA mode) by pressing the FLASH/RECALL button at the beginning of the number (→ 1.10.7 External Feature Access (EFA)).
INTERCOM (Secret)* ¹	[or]	Prevent all or part of a System Speed Dialling number or One-touch Dialling number from being displayed when a call is made, by pressing the INTERCOM button at the beginning and at the end of the number to be hidden (Secret Dialling). It is programmable whether the hidden part will be shown on SMDR (→ 1.20.1 Station Message Detail Recording Feature).
CONF (Hyphen)* ²	-	Store a hyphen by pressing the CONF button.

*¹ Available only when in system/personal programming mode

*² Available only when in system programming mode

[Example of Secret Dialling]

When storing the number "91234567890", to prevent the telephone number "1234567890" from being displayed when making a call:

Enter → → → .

Notes

- The characters for secret code, "[" and "]" (entered by pressing the INTERCOM button), are counted as one digit each.
- It is not possible to hide the Outside (CO) Line Access number (9/0*, or 81 through 88) by pressing the INTERCOM button before dialling it.

* For New Zealand, the Automatic Line Access number may be either 1 or 9.

Conditions

- **Outside (CO) Line Access by Memory Dialling (One-touch Dialling/System Speed Dialling)**
A specific Outside (CO) Line Access number can be stored along with the telephone number in Memory Dialling. However, if Memory Dialling is performed after selecting an outside (CO) line, the stored Outside (CO) Line Access number is ignored and the telephone number is sent using the selected outside (CO) line.

1.6.1.2 One-touch Dialling

Description

A proprietary telephone (PT) user can make a call or access a feature with a one-touch operation. This is possible by storing the number (up to 24 digits), such as an extension number, telephone number, account code, or feature number, as a One-touch Dialling button.

Conditions

- **One-touch Dialling Button**
A flexible CO/Direct Station Selection (DSS)/Programmable Feature (PF)/MESSAGE button can be customised as a One-touch Dialling button.
- A number consisting of 25 digits or more can be stored by dividing it and storing it as 2 separate One-touch Dialling buttons. In this case, the Outside (CO) Line Access number should be stored in the first button.
- Speed Dialling, One-touch Dialling, and manual dialling can be used in combination.
- Personal Speed Dialling numbers (0 through 9) correspond to the numbers (F1 through F10) of the PF buttons assigned as One-touch Dialling numbers.
Assigning a One-touch Dialling number to PF button "F1" will override Personal Speed Dialling number "0", and vice versa.

Feature Guide References

1.18.2 Flexible Buttons

User Manual References

1.2.2 Easy Dialling

1.6.1.3 KX-T7710 One-touch Dialling

Description

The MESSAGE button and each of the 8 One-touch buttons on the KX-T7710 single line telephone (SLT) can be customised to dial an extension number, telephone number, or feature number (up to 24 digits) when the user presses that button. To allow easy configuration of multiple extensions, every KX-T7710 connected to the PBX can be customised with the same settings at once, through system programming (→ KX-T7710 One-touch Dialling [013]). This is useful for hotel room extensions or similar applications.

The KX-T7710 has 2 modes, "NORMAL" mode and "PBX" mode, selected by a switch on the telephone. This feature is available only when the KX-T7710 is in "PBX" mode.

[Programming Example: KX-T7710 One-touch Dialling]

Location No.	Button	Desired Number
1	One-touch Dial 01	100 (Front Desk)
2	One-touch Dial 02	76XX (Wake-up Call)
3	One-touch Dial 03	102 (Restaurant)
(Cont.) :	:	:
:	:	:
9	MESSAGE	784#

Conditions

- System programming determines the SLTs that can receive the message waiting notifications left by another extension (→ SLT Message Waiting [619]).
- If a user goes off-hook with an SLT that has messages waiting, a special dial tone (dial tone 3) will be heard. The user can call a caller back or listen to the message simply by pressing the MESSAGE button because the button includes the default value of Message Waiting Answer feature number.
- Any feature number can be stored in a One-touch button. However, the feature numbers for Personal Speed Dialling, System Speed Dialling, and Quick Dialling do not function.
- KX-T7710 One-touch Dialling is available to users while hearing a dial tone.
- KX-T7710 One-touch Dialling is not available to users when the KX-T7710 is connected in parallel with a proprietary telephone (PT).
- Please refer to the Quick Reference Guide of the KX-T7710 for additional information.

Feature Guide References

1.18.2 Flexible Buttons

1.6.1.4 Redial

Description

There are 2 types of Redial, described below.

Type	Description
Last Number Redial	Every extension automatically saves the last external telephone number dialled, allowing the same number to be easily redialled.
Saved Number Redial	A proprietary telephone (PT) user can save a telephone number while in a conversation with an outside party or while hearing a busy tone, and then easily redial the number later. The saved number is kept until a new number is stored.

Automatic Redial

If Last Number Redial or Saved Number Redial is performed in hands-free mode and the called party is busy, the number will be automatically redialled a preprogrammed number of times (→ Automatic Redial Repeat Count [113]) at a preprogrammed interval (→ Automatic Redial Interval [114]). This feature is only available on PT models that have an SP-PHONE or MONITOR button.

Conditions

[General]

- Up to 64 digits plus the Outside (CO) Line Access number can be stored and redialled for each Redial type.
- Automatic Redial is cancelled if any other number is dialled, or if an incoming call is answered.
- Headset users cannot use the Automatic Redial feature.
- Automatic Redial is not available for some countries/areas.

[Last Number Redial]

- The stored telephone number is replaced whenever a new number is dialled.

[Saved Number Redial]

- **Save Button**
A flexible CO button can be customised as a Save button.

Feature Guide References

1.18.2 Flexible Buttons

User Manual References

1.2.3 Redialling

1.6.1.5 Speed Dialling—Personal/System

Description

An extension user can use short numbers to frequently dialled numbers that are stored in the PBX, either in the extension's Personal Speed Dialling or in System Speed Dialling.

Personal Speed Dialling is also known as Station Speed Dialling.

Conditions

[General]

- Any number, such as a telephone number or feature number, can be stored in Personal Speed Dialling (up to 24 digits) and System Speed Dialling (up to 32 digits).
- This feature is not available on rotary single line telephones (SLTs).

[Personal Speed Dialling]

- Personal Speed Dialling numbers (0 through 9) correspond to the numbers (F1 through F10) of the Programmable Feature (PF) buttons assigned as One-touch Dialling numbers. Assigning a One-touch Dialling number to PF button "F1" will override Personal Speed Dialling number "0", and vice versa.
- An SLT user can check the stored number by exchanging the SLT with a PT. PF buttons (F1 through F10) correspond to Personal Speed Dialling numbers (0 through 9). Press the desired PF button to check the number.

[System Speed Dialling]

- **TRS for System Speed Dialling** (→ TRS—System Speed Dialling Class [301])
Calls made using System Speed Dialling are restricted depending on the class of service (COS) of System Speed Dialling numbers and the COS assigned to each extension (→ 1.8.1 Toll Restriction (TRS)).
- System Speed Dialling numbers (→ System Speed Dialling Number [001]) and names (→ System Speed Dialling Name [011]) can be assigned through system programming. The assigned name will be shown on the display of a proprietary telephone (PT) when an extension user makes calls using this feature.
- **Caller's Name**
If the dialled number matches a number stored in the System Speed Dialling table with an assigned name, the assigned name will be shown on the display (→ 1.16.1 Caller ID).
- System Speed Dialling, One-touch Dialling, and manual dialling can be used in combination.

User Manual References

1.2.2 Easy Dialling

3.3.2 System Programming

1.6.1.6 Quick Dialling

Description

Using Quick Dialling, an extension user can make a call or access a feature easily. This is possible by storing the number (up to 10 digits), such as extension number, telephone number, or feature number, for Quick Dialling through system programming (→ Second Feature Numbering Plan [012]).

[Programming Example: Quick Dialling]

Code No.	Desired Number
50	#34
51	#43
(Cont.) :	:
:	:
59	912345678

In this example:

- a) The feature number for Paging—External, "#34", is stored with the code number "50". Users can make paging announcements by going off-hook and then dialling "50".
- b) The feature number for Paging—Answer, "#43", is stored with the code number "51". Users can answer paging announcements by going off-hook and then dialling "51".
- c) A telephone number, "912345678", is stored with the code number "59". Users can call this outside number by going off-hook and then dialling "59".

Conditions

- This feature is available when "Plan 2" or "Plan 3" is selected in Extension Number [009] (→ 2.3.4 Feature Numbering).

User Manual References

1.2.2 Easy Dialling

1.6.1.7 Hot Line

Description

A single line telephone (SLT) user can make an outgoing call to a previously stored telephone number (up to 32 digits) simply by going off-hook. If the Hot Line feature is set and the user goes off-hook, a special dial tone (dial tone 2) is generated for a preprogrammed time period (→ Hot Line Waiting Time [203]), and then dialling starts. During this waiting time, the user can dial another party, overriding the Hot Line feature.

This feature is also known as Pickup Dialling.

Conditions

- This feature cannot be programmed on rotary SLTs.
- This feature will not function when the extension user goes off-hook to answer an incoming call or retrieve a call on hold.

User Manual References

1.2.2 Easy Dialling

1.7 Busy Line/Busy Party Features

1.7.1 Automatic Callback Busy (Camp-on)

Description

If the dialled extension or outside (CO) line is busy when a call is made, the caller can choose to be informed by a callback ring (Camp-on Recall) when the extension or outside (CO) line becomes free.

When the user answers the callback ring:

For an intercom call: The called extension starts ringing without the user having to redial.

For an outside (CO) line call: The line is seized.

Conditions

- If the callback ring is not answered within 10 seconds (4 rings), the callback is cancelled.
- More than one extension user can set this feature to monitor the same destination extension or outside (CO) line at the same time.

User Manual References

1.2.4 When the Dialled Party is Busy or There is No Answer

1.7.2 Executive Busy Override

Description

An extension user can interrupt an existing call to establish a 3-party conference call.

Executive Busy Override Deny

It is possible for extension users to prevent their calls from being interrupted by another extension user.

Conditions

- System programming determines extension users who can use Executive Busy Override (→ Executive Busy Override [608]).
- This feature will not function when the busy extension has set Executive Busy Override Deny or Data Line Security (→ 1.10.5 Data Line Security).
- When a 2-party conversation is changed to a 3-party conference call, a confirmation tone will be sent to all parties (→ 1.13.1.2 Conference). It is possible to eliminate the tone through system programming (→ Conference Tone [105]).

User Manual References

1.2.4 When the Dialed Party is Busy or There is No Answer

1.7.4 Preventing Other People from Joining Your Conversation (Executive Busy Override Deny)

1.7.3 Call Waiting Tone

Description

When an extension user attempts to call a busy extension (i.e., an extension that is ringing or having a conversation), a call waiting tone will be sent to the called extension to indicate another call is waiting.

Conditions

- This feature functions only if the called extension has activated Call Waiting. If it is activated, the calling extension will hear a ringback tone.
- One of 2 call waiting tones (Tone 1 or Tone 2) can be selected through personal programming (Call Waiting Tone Type Selection). For doorphone calls, Tone 1 is used as a call waiting tone (not changeable). Tone 2 depends on the assignments in CO Line Ring Tone Pattern [423] for outside (CO) line calls and in Extension Ring Tone Pattern [115] for intercom calls.

Feature Guide References

- 1.1.3.5 Call Waiting
- 4.2.1 Tones/Ring Tones

User Manual References

- 3.1.2 Changing Personal Settings Using Programming Mode

1.8 Toll Restriction (TRS) Features

1.8.1 Toll Restriction (TRS)

Description

Toll Restriction (TRS) can prohibit certain extension users from making unauthorised outside (CO) line calls. Every extension is assigned to one of 5 classes of service (COSs) for each time service mode (→ TRS—COS—Day/Night/Lunch [601-603]); COS 1 grants the highest level of authorisation, allowing all outside (CO) line calls to be made, and COS 5 grants the lowest level of authorisation. COSs 2 through 5 are used to restrict calls with a combination of preprogrammed Denied and Exception Code Tables, explained below.

Denied Code Tables (→ TRS—COS 2-5 Denied Code [302-305])

Denied Code Tables are preprogrammed lists containing the telephone numbers that are restricted. All outgoing outside (CO) line calls made by COS 2 through 5 users are compared to the applicable Denied Code Table(s), and when the leading number of a dialled telephone number (not including the Outside (CO) Line Access number) matches an entry found in an applicable table, the call is denied.

Up to a total of 80 denied codes, each consisting of up to 11 digits, can be stored.

Exception Code Tables (→ TRS—Exception Code [306])

Exception Code Tables are preprogrammed lists of leading digits or complete telephone numbers that are checked against every dialled number prohibited by a Denied Code Table. When a dialled number is prohibited by a Denied Code Table, it is compared to the applicable Exception Code Table(s). If the dialled number matches an entry found in an applicable Exception Code Table, the call is permitted.

Up to 80 exception codes, each consisting of up to 11 digits, can be stored. The available number of codes depends on the COS assigned to each extension.

Applicable tables by COS

The Denied Code Tables and Exception Code Tables that apply to each COS are listed below.

COS No.	Denied Code Tables	Exception Code Tables
1	No restriction. (Not Programmable)	No restriction. (Not Programmable)
2	20 denied codes programmed in [302]. (Table for Class 2)	80 exception codes (code numbers 01–80) programmed in [306]. (Tables for Classes 2 through 5)
3	40 denied codes programmed in [302] and [303]. (Tables for Classes 2 and 3)	60 exceptions codes (code numbers 01–60) programmed in [306]. (Tables for Classes 3 through 5)
4	60 denied codes programmed in [302] through [304]. (Tables for Classes 2 through 4)	40 exception codes (code numbers 01–40) programmed in [306]. (Tables for Classes 4 and 5)
5	80 denied codes programmed in [302] through [305]. (Tables for Classes 2 through 5)	20 exception codes (code numbers 01–20) programmed in [306]. (Table for Class 5)

1.8 Toll Restriction (TRS) Features

COS 1	All outside (CO) line calls permitted.	
COS 2	Class 2 restriction	Class 2 – 5 exceptions
COS 3	Class 2 – 3 restrictions	Class 3 – 5 exceptions
COS 4	Class 2 – 4 restrictions	Class 4 – 5 exceptions
COS 5	Class 2 – 5 restrictions	Class 5 exception

Calls are restricted
 Calls are permitted

TRS for System Speed Dialling (→ TRS—System Speed Dialling Class [301])

Calls made using System Speed Dialling are restricted depending on the COS of System Speed Dialling numbers and the COS assigned to each extension. If, for example, the COS of System Speed Dialling numbers is assigned as "2", the PBX will allow System Speed Dialling calls for the extensions with COSs 1 and 2, but not allow System Speed Dialling calls for the extensions with COSs 3, 4, and 5 according to TRS as follows:

COS No.	System Speed Dialling Class				
	1	2	3	4	5
1	✓	✓	✓	✓	✓
2		✓	✓	✓	✓
3			✓	✓	✓
4				✓	✓
5					✓

✓ Permitted

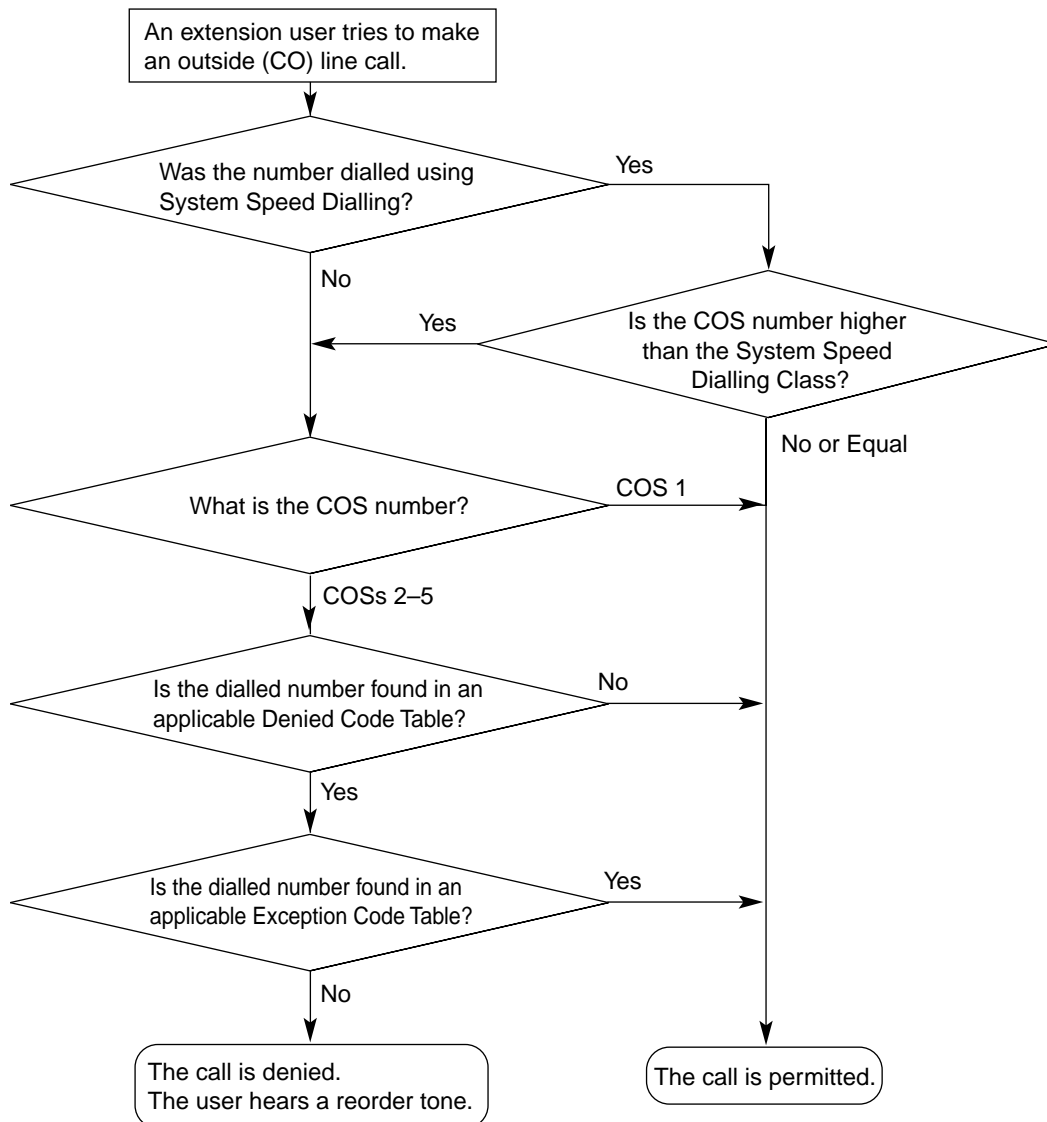
[Flowchart]**Conditions****WARNING**

The software contained in the TRS feature to allow user access to the network must be upgraded to recognise newly established network area codes and exchange codes as they are placed into service.

Failure to upgrade the on-premise PBXs or peripheral equipment to recognise the new codes as they are established will restrict the customer and users of the PBX from gaining access to the network and to these codes.

KEEP THE SOFTWARE UP TO DATE WITH THE LATEST DATA.

- Emergency numbers, such as the police or fire services, should be stored (→ Emergency Number [309]) so that they are not barred by TRS.
- **Host PBX Access Code/Carrier Exception Code**
TRS checks can be carried out on telephone numbers dialled using a Host PBX Access code (→

1.8 Toll Restriction (TRS) Features

1.5.2.8 Host PBX Access Code (Access Code to the Telephone Company from a Host PBX) or Carrier Exception code.

Access Code Type	Access Code is stored in the PBX		Access Code is not stored in the PBX
	Access Code is dialled	Access Code is not dialled	
Host PBX Access Code *1	TRS ignores the code and checks the remaining digits.	Number dialled is not an outside (CO) line call, so TRS does not check the number.	TRS checks the entire number.
Carrier Exception Code *2	TRS ignores the code and checks the remaining digits.	TRS checks the entire number.	TRS checks the entire number.

*1 → Host PBX Access Code [403]

*2 → Carrier Exception Code [300]

- The inter-digit timer (→ Inter-digit Time [208]) applies until the TRS check is completed. When the timer expires, the outgoing outside (CO) line call is disconnected while dialling, if enabled through system programming (→ No Dial Disconnection [211]). For a single line telephone (SLT), an outgoing outside (CO) line call will be released from the DTMF (Dual Tone Multi-Frequency) receiver when the inter-digit timer expires.
- **TRS—Extension Lock Class**
The COS of extensions locked by the Extension Lock or Remote Extension Lock feature (→ 1.8.4 Extension Lock) can be assigned (→ TRS—Extension Lock Class [312]) so that even a locked extension can make outside (CO) line calls. The higher COS number will take precedence. If, for example, COS 3 is assigned to an extension (→ TRS-COS—Day/Night/Lunch [601-603]) and the COS of locked extensions is assigned as "4", when the extension is locked, the PBX allows the extension user to make outside (CO) line calls using COS 4.
- The PBX can also be programmed to perform a TRS check for numbers that contain nondigits (* or #) (→ TRS Check for * and # [125]). If TRS check is disabled, the PBX ignores any nondigits that are dialled when checking, which is useful in preventing some unauthorised calls.

Feature Guide References

1.6.1.5 Speed Dialling—Personal/System

2.2.1 Class of Service (COS)

1.8.2 Toll Restriction (TRS) Override by Account Code

Description

An extension user can override TRS temporarily to make a toll call from a toll-restricted telephone (→ 1.8.1 Toll Restriction (TRS)). The extension user can carry out this feature by entering the appropriate account code before dialling the telephone number (→ Account Code [310]).

[Flowchart]

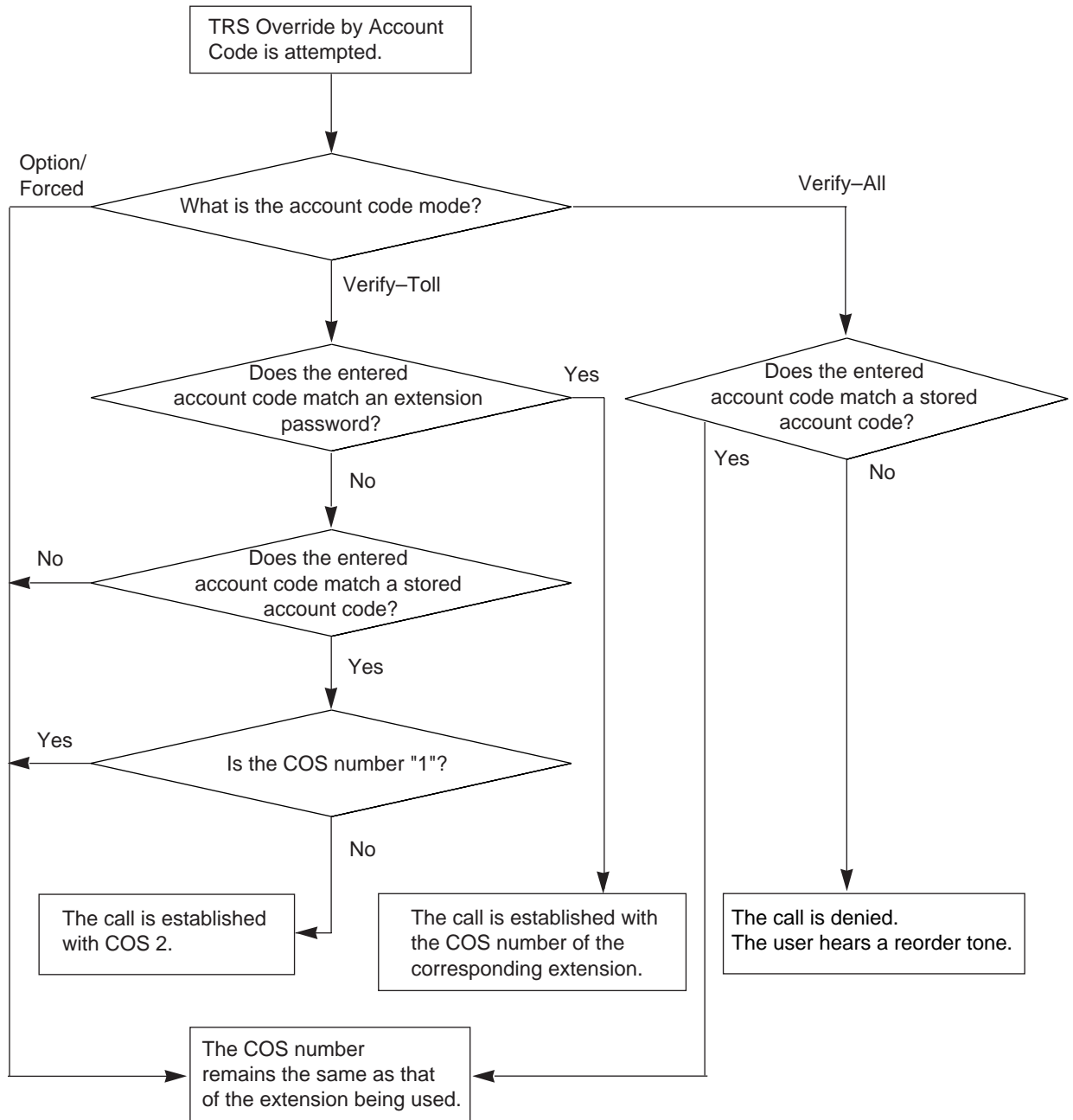

Conditions

- This feature functions only for extensions whose:
 - Account code mode is set to "Verify-Toll" (→ Account Code Mode [605]).
 - Class of service (COS) number is set to 3 through 5.
- If the extension user does not enter an account code or enters an invalid account code, an ordinary TRS check is performed.
- System programming determines whether SMDR (→ 1.20.1 Station Message Detail Recording Feature) logs the 4-digit account code or the 2-digit index of the account code when an extension user makes a call using this feature (→ SMDR Account Code [805]).
- It is also possible to override TRS at another extension using the Walking COS feature (→ 1.8.5 Walking COS).

Feature Guide References

1.5.2.3 Account Code Entry

1.8.3 Budget Management

Description

Limits telephone usage to a preprogrammed budget on each extension (→ Budget Management [925]). If the total of call charges reaches the limit, the extension user cannot make further outside (CO) line calls. An extension assigned as the manager can increase the limit or clear the previous call charges through manager programming.

Conditions

- **Budget Limit Selection**
The method of limiting calls can be selected through system programming (→ Budget Limit Selection [926]):
 - a) Enable (Disconnect the call after the beeps):** 3 sets of 3 beeps will be heard before an outside (CO) line call is disconnected due to budget limitation. The first set of beeps will be heard when the call reaches the last 3 units of remaining time. The call is disconnected as soon as the budget limit is reached, at the start of the final unit of time.
 - b) Disable (From the next call):** The current call is not disconnected but other outside (CO) line calls cannot be made once the call has finished.
- Even when the call charge is set to "0" (→ 1.20.2 Call Charge Calculation), calls cannot be made if the budget limit of an extension has been reached. However, any numbers programmed as Emergency Numbers can be dialed regardless of this (→ Emergency Number [309]).
- When an extension user makes an outside (CO) line call with multiple outside parties simultaneously (for example, using the conference call feature), the extension's total remaining budget will not be divided by each outside (CO) line call. This may cause the total of call charges to exceed the budget limit.

Feature Guide References

1.20.2 Call Charge Calculation

User Manual References

3.2.2 Managing Call Logs and Call Charges

1.8.4 Extension Lock

Description

Extension users can lock their telephones to prevent unauthorised use. This is useful for situations when extension users must leave their desks temporarily. Any 4-digit code can be used to lock and unlock an extension.

This feature is also known as Electronic Station Lockout.

Conditions

- **Remote Extension Lock**
An extension assigned as the operator or manager extension can remotely lock or unlock an extension using a Direct Station Selection (DSS) Console. This feature functions only if the operator or manager has set the extension password. When the operator or manager locks an extension remotely, the extension's user cannot unlock it. When a user locks an extension, the operator or manager extension can override the lock and unlock the extension.
This feature is also known as Remote Station Lock Control.
- **TRS—Extension Lock Class**
The class of service (COS) of extensions locked by the Extension Lock or Remote Extension Lock feature can be assigned (→ TRS—Extension Lock Class [312]) so that even a locked extension can make outside (CO) line calls. The higher COS number will take precedence. If, for example, COS 3 is assigned to an extension (→ TRS-COS—Day/Night/Lunch [601-603]) and the COS of locked extensions is assigned as "4", when the extension is locked, the PBX allows the extension user to make outside (CO) line calls using COS 4.
- **Extension Lock—CANCEL ALL**
The operator or manager can cancel this feature for all extensions simultaneously.
- **Extension Lock Button**
A flexible DSS button on a DSS Console can be customised as an Extension Lock button.
- This feature also functions as Incoming Call Log Display Lock (→ 1.16.2 Incoming Call Log).
The Incoming Call Log for the common area can only be locked or unlocked by the operator or manager.
- This feature will not block Emergency Calls (→ 1.5.2.2 Emergency Call).

Feature Guide References

- 1.8.1 Toll Restriction (TRS)
- 1.18.2 Flexible Buttons

User Manual References

- 1.5.3 Preventing Other People from Using Your Telephone (Extension Lock)
- 2.1.1 Locking Other Extensions (Remote Extension Lock)
- 2.1.7 Changing System Settings Using Programming Mode
- 3.1.3 Customising the Buttons

1.8.5 Walking COS

Description

Extension users can temporarily assign their own class of service (COS) to another extension, allowing them to make calls as if from their own telephones.

This feature is useful when a manager or supervisor needs to borrow another employee's telephone to make a call. The superior enters the extension password followed by the Walking COS feature number and his or her extension number, and then makes the call. The same privileges and restrictions normally applied to a user are applied when using Walking COS.

Conditions

- When making a call with Walking COS, the extension number of the Walking COS user's extension is also logged by SMDR (→ 1.20.1 Station Message Detail Recording Feature).

Feature Guide References

2.2.1 Class of Service (COS)

User Manual References

1.2.6 Using Your Calling Privileges at Another Extension (Walking COS)

2.1.7 Changing System Settings Using Programming Mode

1.9 Automatic Route Selection (ARS) Features

1.9.1 Automatic Route Selection (ARS)

Description

The PBX automatically selects the least expensive route (carrier) available at the time a long-distance call is made on an outside (CO) line that has Automatic Route Selection (ARS) enabled. In order to use ARS effectively, various ARS-related tables must be preprogrammed to tell the PBX which calls should be placed using which carriers.

[Flowchart]

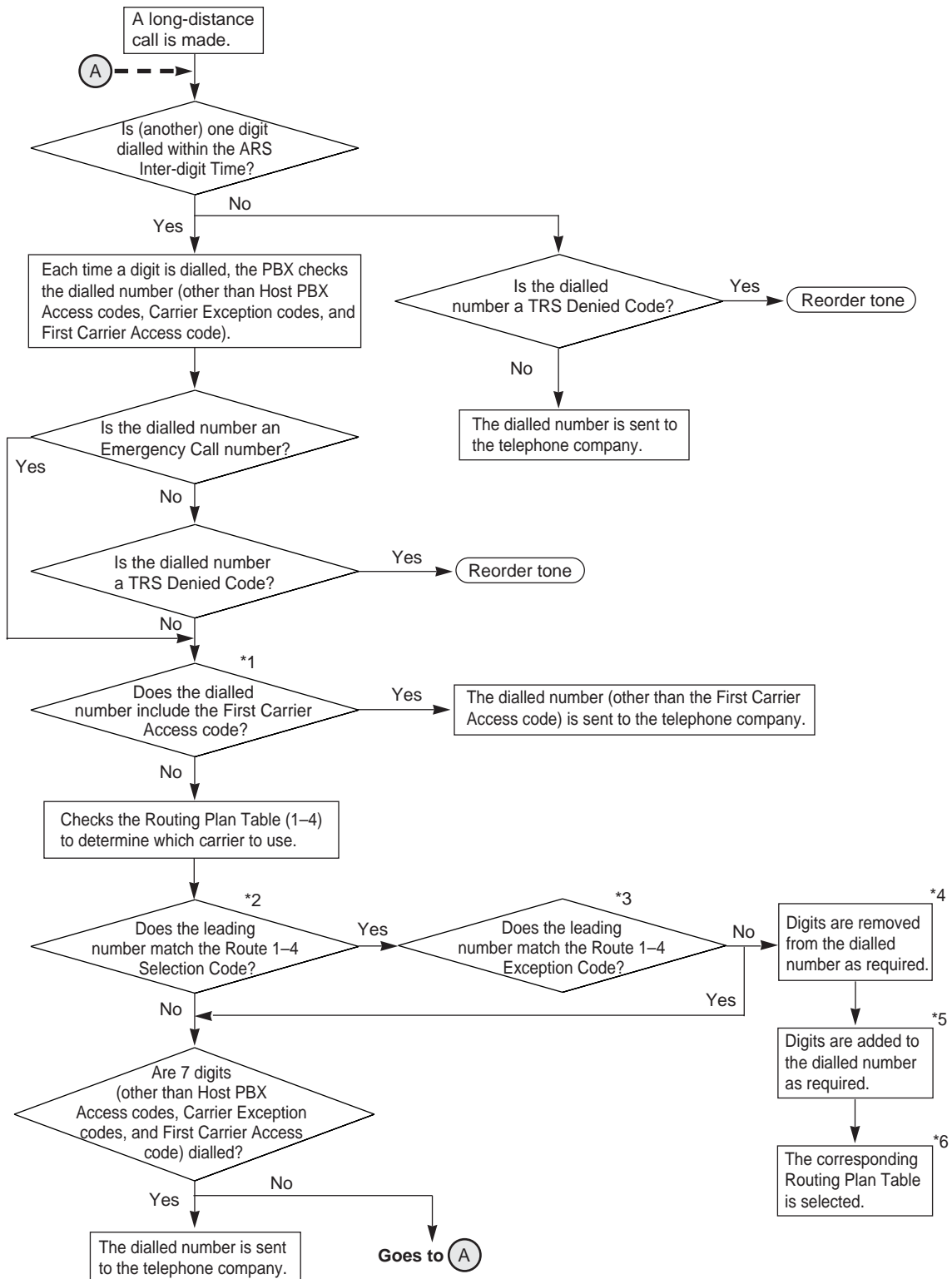

1.9 Automatic Route Selection (ARS) Features

[Programming Procedures]

1. ARS Mode (→ ARS Selection [350])

Turn on ARS for each outside (CO) line.

2. First Carrier Access Code*¹

Enter the carrier's access code, such as the Host PBX Access code (→ Host PBX Access Code [403]), Carrier Exception code (→ Carrier Exception Code [300]), or First Carrier Access code (→ 1st Carrier Selection Code [359]). For example, if the dialled number is "000-93-425-9477" and the First Carrier Access code is assigned as "000", the modified number is "93-425-9477". Consult your carrier for more information.

3. Routing Plan Table

Leading Number*² (→ Route 1-4 Selection Code [351-354])

Store the leading numbers of telephone numbers that should be routed by ARS.

Leading Number Exception*³ (→ Route 1-4 Exception Code [355-358])

Store the telephone numbers that will bypass ARS here.

Note that the Outside (CO) Line Access number is always ignored by ARS and does not need to be programmed here.

Calls that are exempt from ARS are connected via the default carrier for that line.

Removed Number of Digits*⁴ (→ ARS Modification—Removed Digits [360])

There may be circumstances where the user-dialled number must be modified in order for the carrier to connect the call. In this case, store the number of digits to be removed automatically from the beginning of the dialled number here.

Added Number*⁵ (→ ARS Modification—Added Number [361])

Store the number to be added automatically to the beginning of the dialled number here.

ARS Outside (CO) Line Group*⁶ (→ ARS CO Line Group [364])

When making outside (CO) line calls using the Automatic Line Access number (9/0)*, assign the outside (CO) line group(s) for each Routing Plan number here.

An outside (CO) line belonging to the assigned outside (CO) line group(s) is automatically seized when making calls using the Automatic Line Access number, and the dialled number is applied to one of the Routing Plan numbers.

Note

* For New Zealand, the Automatic Line Access number may be either 1 or 9.

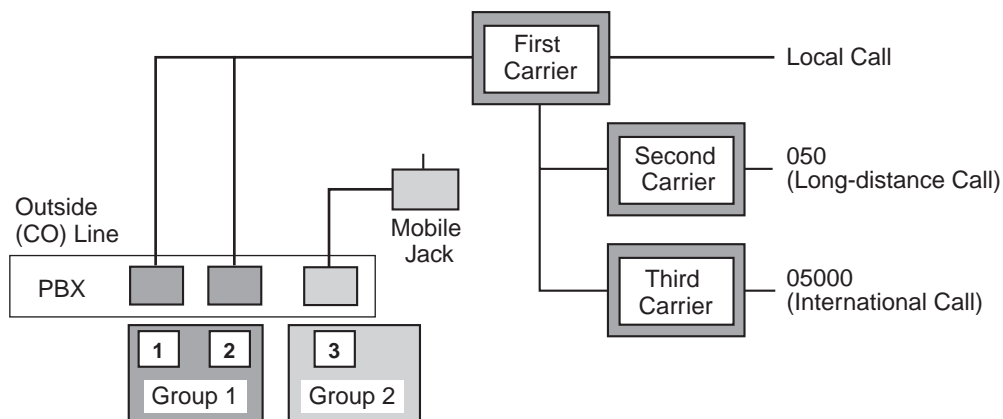

[Programming Example: Routing Plan Table]

Routing Plan No.	Leading No.*1	Leading No. Exception*2	Modification		ARS Outside (CO) Line Group*5
			Removed No. of Digits*3	Added No.*4	
1	4,5	07	0	050	All
2	9,0	07	0	050	1
3	07	Not Stored	2	05000	1
4	6	Not Stored	0	Not Stored	2

*1 → Route 1-4 Selection Code [351-354]

*2 → Route 1-4 Exception Code [355-358]

*3 → ARS Modification—Removed Digits [360]

*4 → ARS Modification—Added Number [361]

*5 → ARS CO Line Group [364]

In this example:

Dialled Number	Modified Number	Description
9-43-425-9477	050-43-425-9477	A long-distance call is made using Routing Plan 1 when the Automatic Line Access number is assigned to "9".
9-54-123-4567	050-54-123-4567	A long-distance call is made using Routing Plan 1 when the Automatic Line Access number is assigned to "9".
9-93-425-9477	050-93-425-9477	A long-distance call via outside (CO) line group 1 is made using Routing Plan 2.
9-04-123-4567	050-04-123-4567	A long-distance call via outside (CO) line group 1 is made using Routing Plan 2.
9-07-81-92-477-1450	050-00-81-92-477-1450	An international call via outside (CO) line group 1 is made using Routing Plan 3.
9-6-123456	6-123456	A mobile telephone call via outside (CO) line group 2 is made using Routing Plan 4.

4. Authorisation Code & Itemised Billing Code Table

Authorisation Code (→ Route 1-4 Authorisation Code [381-384])

An Authorisation code for each carrier can be assigned for each outside (CO) line, if required by the carrier. The registered codes are not shown on proprietary telephone (PT) displays or System Data Dump printouts (→ System Data Dump [804]) after programming, but "Already set" will be shown instead.

Itemised Billing Code (→ Itemised Billing Code [389])

An Itemised Billing code can be assigned for each extension. It is possible to add the Itemised Billing code assigned to an extension to the Authorisation code for the carrier for each outside (CO) line through system programming (→ Route 1-4 Itemised Billing [385-388]).

1.9 Automatic Route Selection (ARS) Features

Sequence of Transmitted Code (→ Authorisation and Itemised Billing Code Order [390])

The sequence of transmitted codes (C: Carrier Access Code; A: Authorisation Code; I: Itemised Billing Code; H: Telephone Number) can be selected. When "C.I.A.H" is selected, the dialled numbers of Itemised Billing Code (I) and Authorisation Code (A) are shown on the displays of PTs and SMDR (→ 1.20.1 Station Message Detail Recording Feature).

[Programming Example: Authorisation & Itemised Billing Code Table]

Routing Plan No.	Leading No.	Modification		Authorisation Code*1	Itemised Billing*2
		Removed No. of Digits	Added No.		
1	8	0	11223344	0123456789 (on CO 1/2)	Enable (on CO 1/2) (Itemised Billing Code: Extn. 101)
2	5	0	11223344PPPP *#012345 (PPPP: 6 s, *#: Pulse to Tone Conversion (→ 1.5.2.4 Dial Type Selection))	67890123456 789 (on CO 1)	Enable (on CO 1) (Itemised Billing Code: Extn. 101)

*1 → Route 1-4 Authorisation Code [381-384]

*2 → Route 1-4 Itemised Billing [385-388]

In this example:

Dialled Number	Modified Number	Description
9-893-425-9477 (Extn. 101)	<p>11223344-P*2-0123456789-101-893-425-9477</p> <p>Added No. Authorisation Code Itemised Billing Code Telephone No.</p> <p>Pulse*1 (→ Dial Mode [401]) P (Pause)*2 (→ Pause Time [417])</p>	<p>A call via provider access is made using Routing Plan 1 when the Automatic Line Access number is assigned to "9".</p> <p>The Authorisation code and the Itemised Billing code are transmitted in tone mode.</p> <p>The pause time is automatically inserted before entering the Authorisation code.</p>
9-593-425-9477 (Extn. 101)	<p>11223344-PPPP-012345-P-67890123456789-101-593-425-9477</p> <p>Added No. Authorisation Code Itemised Billing Code Telephone No.</p>	<p>A call via provider access is made using Routing Plan 2 when the Automatic Line Access number is assigned to "9".</p>

Conditions

WARNING

The software contained in the ARS feature to allow user access to the network must be upgraded to recognise newly established network area codes and exchange codes as they are placed into service.

Failure to upgrade the on-premise PBXs or peripheral equipment to recognise the new codes as they are established will restrict the customer and users of the PBX from gaining access to the network and to these codes.

KEEP THE SOFTWARE UP TO DATE WITH THE LATEST DATA.

- **ARS Inter-digit Time**

The inter-digit time used while the PBX is checking the dialled number for the ARS feature can be specified through system programming (→ ARS Inter-digit Time [363]).

- **TRS**

TRS checks are performed before ARS number modification, so programme TRS Denied Code Tables and Exception Code Tables accordingly (→ 1.8.1 Toll Restriction (TRS)).

- If an extension user makes calls using the Automatic Line Access number, and the leading number of a dialled telephone number does not match any entries found in the Leading Number, an outside (CO) line enabled in Automatic Designated Line Access [419] is automatically seized.
- The PBX checks the number repeatedly until 7 digits have been dialled.
- If an extension user makes an outside (CO) line call by directly pressing a Single-CO (S-CO), Group-CO (G-CO), or Other-CO (O-CO) button or by dialling an assigned Outside (CO) Line Group Access number, and the seized outside (CO) line has been enabled in ARS Selection [350], the call is made with the ARS feature.

1.10 Conversation Features

1.10.1 Hands-free Operation

Description

A proprietary telephone (PT) user can talk to another party without lifting the handset. Pressing specific buttons automatically activates hands-free mode.

Conditions

- **PTs with the MONITOR Button**
PTs with the MONITOR button can dial in hands-free mode but cannot have hands-free conversations.
- Hands-free mode is cancelled if an extension user does not start dialling within 10 seconds.
- This feature can be used by pressing the following buttons when the indicator of the SP-PHONE/MONITOR button is off:
 - SP-PHONE button
 - MONITOR button
 - INTERCOM button
 - CO button

User Manual References

1.4.8 Talking to Another Party without Lifting the Handset (Hands-free Operation)

1.10.2 Room Monitor

Description

An extension user can monitor a room or a door through another proprietary telephone (PT) or a doorphone without the destination party knowing.

Conditions

- To monitor using this feature, an extension must have a PT with an AUTO ANS/MUTE button or a single line telephone (SLT) with a MUTE button. To be monitored using this feature, an extension must have a PT with an AUTO ANS/MUTE button.
- System programming determines the extensions that can be monitored using this feature (→ Room Monitor [612]).
- A doorphone access tone will be sent to a monitored doorphone before monitoring starts (→ 1.15.1 Doorphone Call). If an extension user wants to monitor a doorphone without informing the other party, it is possible to eliminate the tone through system programming (→ Doorphone Access Tone [707]).
- Access tones will not be sent to a monitored PT. Paging tones will also not be received by a monitored PT.

User Manual References

1.7.9 Monitoring a Room (Room Monitor)

1.10.3 Microphone Mute

Description

During a conversation, a proprietary telephone (PT) user can disable the built-in microphone to consult privately with others in the room while listening to the other party on the phone through the built-in speaker. When Microphone Mute is active, the user can hear the other party's voice, but the user's voice is muted.

Conditions

- This feature is only available on PTs that have an AUTO ANS/MUTE button.

User Manual References

1.4.6 Muting a Microphone (Microphone Mute)

1.10.4 Headset Operation

Description

This PBX supports headset-compatible proprietary telephones (PTs). A PT user can talk to another party without lifting the handset by using an optional headset.

For connection and operation, refer to the Operating Instructions for the headset.

This feature is also known as Handset/Headset Selection.

Conditions

- Headset users cannot use the Automatic Redial feature (→ 1.6.1.4 Redial).
- To set headset mode on a PT, use the handset/headset selector located on the telephone and/or on the headset.
- If headset mode is on, pressing the SP-PHONE button activates the headset, not the built-in speaker.

User Manual References

1.4.7 Using the Headset (Headset Operation)

1.10.5 Data Line Security

Description

Once Data Line Security is set on an extension, communication between the extension and the other party is protected from signals such as Call Waiting, Hold Recall, and Executive Busy Override. Extensions that have devices such as modems, fax machines, or Voice Processing Systems (VPSs) connected to them may set this feature to maintain secure data transmission, by blocking tones or other interruptions during communication.

User Manual References

1.7.6 Protecting Your Line against Notification Tones (Data Line Security)

1.10.6 Flash/Recall

Description

A proprietary telephone (PT) user can use the FLASH/RECALL button to disconnect the current call and start another call without hanging up. For example, if this button is used to disconnect an outside (CO) line, the extension user will hear a new dial tone from the same outside (CO) line.

Conditions

- **FLASH/RECALL Button Mode**
One of the following modes can be selected through system programming (→ Flash/Recall Key Mode [110]):
 - a) **MODE 1: EFA mode** (→ 1.10.7 External Feature Access (EFA))
An EFA signal is sent for the specified duration (→ Flash/Recall Time [418]).
 - b) **MODE 2: Flash/Recall mode**
A flash/recall signal is sent when the FLASH/RECALL button is pressed if the length of time that the button is pressed is longer than the specified duration (→ Flash/Recall Time [418]). If the length of time that the button is pressed is shorter than the specified duration, an EFA signal will be sent for the specified duration.
- This feature functions only if the FLASH/RECALL button is set to "MODE 2: Flash/Recall mode".
- **Disconnect Time**
The amount of time between successive accesses to the same outside (CO) line is programmable for each outside (CO) line (→ Disconnect Time [422]).
- Pressing the FLASH/RECALL button restarts the conversation duration, outputs an SMDR call record (→ 1.20.1 Station Message Detail Recording Feature) and checks the Toll Restriction (TRS) class of service (COS) number again. The notation "F/" will be logged along with the new dial number on SMDR.

1.10.7 External Feature Access (EFA)

Description

An extension user can access features of a host PBX or the telephone company, such as Call Waiting. An EFA (External Feature Access) signal is sent to the host PBX or the telephone company. This feature is only available during outside (CO) line calls, including Host PBX Access (→ 1.5.2.8 Host PBX Access Code (Access Code to the Telephone Company from a Host PBX)).

Conditions

- This feature functions only if the FLASH/RECALL button is set to "MODE 1: EFA mode" (→ 1.10.6 Flash/Recall). It is also possible to perform this feature by entering the EFA feature number when the current call is placed on consultation hold (→ 1.12.5 Consultation Hold).
- **Flash/Recall Time**
The length of an EFA signal can be selected for each outside (CO) line (→ Flash/Recall Time [418]).

User Manual References

1.8.2 If a Host PBX is Connected

1.10.8 Outside (CO) Line Call Limitation

Description

Outside (CO) line calls are limited by the following features:

Feature	Description
Extension-to-Outside (CO) Line Call Duration	When a call between an extension user and an outside party is established, the call duration is restricted by a timer (→ Extension-to-CO Line Call Duration [212]). Both parties will hear a warning tone at 5-second intervals 15 seconds before the timer expires. When the timer expires, the call is disconnected. System programming determines which extensions have calls limited by this feature (→ CO Line Call Duration Limitation [613]). This timer applies to outside (CO) line calls that are made via the PBX.
Outside-to-Outside (CO-to-CO) Line Call Duration	When a call between 2 outside parties is established, the call duration is restricted by a timer (→ CO-to-CO Line Call Duration [205]). Both parties will hear a warning tone 15 seconds before the timer expires. When the timer expires, the call is disconnected.
Budget Management	When the total of call charges reaches a specified limit, an extension user hears an alarm (3 sets of 3 beeps) and the user cannot make further outside (CO) line calls. Whether the call is disconnected after the alarm is programmable (→ 1.8.3 Budget Management).

Conditions

- **Lockout**
If one party in a conversation goes on-hook, the call between both parties will be disconnected. A reorder tone is sent to the off-hook party before the call is disconnected. No operation is necessary.
- When an extension user seizes an outside (CO) line and then transfers the call to another extension user who can use this feature, the Extension-to-Outside (CO) Line Call Duration timer starts after the transferred call is answered by the outside party.
- The Outside-to-Outside (CO-to-CO) Line Call Duration feature applies to the following calls:
 - Calls forwarded by the FWD to Outside (CO) Line feature (→ 1.3.1.2 Call Forwarding (FWD))
 - Calls transferred by the Call Transfer to Outside (CO) Line feature (→ 1.11.1 Call Transfer)
 - Calls using the DISA feature (→ 1.15.6 Direct Inward System Access (DISA))
 - Calls using the Unattended Conference feature (→ 1.13.1.2 Conference)

1.10.9 Paralleled Telephone

Description

Any proprietary telephone (PT) can be connected in parallel with a single line device, such as a single line telephone (SLT), fax machine, or modem.

When parallel mode is used, the 2 telephones function as follows:

- Both share one extension number.
- Either telephone or device can make or answer calls.

Conditions

- System programming determines the SLTs that can be connected in parallel with a PT (→ Paralleled Telephone [610]).
- When the SLT is in operation, the display and LED (Light Emitting Diode) indicator on the paired PT will function in the same way as when the PT is in operation.
- The following features cannot be used with an SLT connected in parallel with a PT:
 - Call Splitting
 - Conference
 - Door Open while connected to the doorphone
 - External Feature Access (EFA)
 - Hot Line
- An SLT connected in parallel with a PT will not ring if the PT is:
 - In Hands-free Answerback mode (→ 1.4.1.4 Hands-free Answerback).
 - In Voice-calling mode (Alternate Receiving—Ring/Voice) (→ 1.5.1.1 Intercom Call).
- An extension user cannot make a call from the SLT if the PT is:
 - Playing background music (BGM)
 - Receiving a paging announcement over the built-in speaker
 - In programming mode
- Both the PT and the SLT will ring for incoming calls (if the ringer is turned on).
- If one telephone goes off-hook while the other telephone is having a call, a 3-party conference call will be established. If one telephone goes on-hook, the other telephone will continue with the call.

Installation Manual References

2.5.2 Connecting Extensions in Parallel

1.10.10 Calling Party Control (CPC) Signal Detection

Description

A CPC (Calling Party Control) signal is an on-hook indication (disconnect signal) sent from an outside (CO) line when the other party hangs up. To maintain efficient utilisation of outside (CO) lines, the PBX monitors each line's status and when a CPC signal is detected on a line, the PBX disconnects the line and alerts the extension with a reorder tone.

Conditions

- CPC Signal Detection is programmable for incoming outside (CO) line calls (→ CPC Signal Detection—Incoming [420]) and for outgoing outside (CO) line calls (→ CPC Signal Detection—Outgoing [421]).
- If a CPC signal is detected during a call between a caller using the DISA feature (→ 1.15.6 Direct Inward System Access (DISA)) and an extension or an outside party, the call will be disconnected.
- It is possible to select whether the PBX detects the reverse signal from incoming outside (CO) line calls for the duration (→ CPC Signal Detection—Incoming [420]) specified through system programming (→ Incoming Reverse [153]).

1.11 Transferring Features

1.11.1 Call Transfer

Description

An extension user can transfer a call to another extension or to an outside party. The following features are available:

Feature	Transferring method
With Announcement	Transfer is completed after announcing the transfer to the destination party.
Without Announcement	Transfer is completed without an announcement. After dialling the destination extension number and hearing a ringback tone or busy tone, the originator can replace the handset.

Call Transfer with Announcement is also known as Call Transfer—Screened.

Call Transfer without Announcement is also known as Call Transfer—Unscreened.

Conditions

- System programming determines the extensions that are able to transfer calls to an outside party (→ Call Transfer to CO Line [606]). Single line telephone (SLT) users cannot transfer calls to an outside party.
- **Transfer Recall for Call Transfer without Announcement**
If the transfer destination extension does not answer within a preprogrammed time period (→ Transfer Recall Time [201]), the call will return to the extension that transferred the call. If there is no answer for 30 minutes after Transfer Recall starts, the call will be disconnected.
- **Camp-on Transfer for Call Transfer without Announcement**
Call Transfer without Announcement is possible while hearing a busy tone, or while hearing a ringback tone after executing Busy Station Signalling (BSS). When the destination extension becomes idle, the transferred call starts ringing automatically at that extension. This is called Camp-on Transfer.
- **One-touch Transfer**
Direct Station Selection (DSS) Console users and proprietary telephone (PT) users can hold an outside (CO) line call and quickly transfer it to an extension by pressing the DSS button directly (→ One-touch Transfer Using a DSS Button [005]).
A flexible CO/DSS/MESSAGE button can also be customised as a DSS button.
- Music, if available, is sent to the held outside party while the call is being transferred (→ 1.12.4 Music on Hold). An internal audio source, external audio source, or tone can be selected as the Music on Hold through system programming (→ Music on Hold [111]).
- **Outside (CO) Line Call Duration**
If an outside (CO) line call is transferred to an outside party, the call duration will be restricted by a system timer (→ CO-to-CO Line Call Duration [205]). Both parties will hear a warning tone 15 seconds before the timer expires (→ 1.10.8 Outside (CO) Line Call Limitation). The extension that transferred the call will also hear a ring tone or an alarm tone 50 seconds before the timer expires (→ 1.12.1 Call Hold). When the timer expires, the call is disconnected unless the extension joins the conversation again.
- If a CPC (Calling Party Control) signal or reverse signal is received from an outside (CO) line, the corresponding call between 2 outside parties will be disconnected.

- **Consultation Hold**

When a transferring party presses the TRANSFER button on a PT or the Recall/hookswitch on an SLT, the transferred party is automatically placed on consultation hold (→ 1.12.5 Consultation Hold).

Feature Guide References

1.18.2 Flexible Buttons

User Manual References

1.4.1 Transferring a Call (Call Transfer)

1.12 Holding Features

1.12.1 Call Hold

Description

An extension user can put a call on hold. The following Call Hold features are available:

Feature	Description
General Call Hold	Any extension user can retrieve a held call.
Exclusive Call Hold	Only the proprietary telephone (PT) user who held the call can retrieve it.

Pressing the HOLD button multiple times alternates between General and Exclusive Call Hold.

Conditions

- Using the Call Hold feature, a PT user can have one intercom call and multiple outside (CO) line calls on hold at the same time. To hold multiple intercom calls, the user should use the Call Park feature (→ 1.12.2 Call Park). Using the Call Hold feature, a single line telephone (SLT) user can have either one intercom call or one outside (CO) line call on hold. To hold multiple calls, the user should use the Call Park feature.
- If an outside party is placed on hold and the call is not retrieved within 30 minutes, the call is automatically disconnected.
- Music on Hold**
Music, if available, is sent to the outside party on hold (→ 1.12.4 Music on Hold). An internal audio source, external audio source, or tone can be selected as the Music on Hold through system programming (→ Music on Hold [111]).
- Doorphone calls cannot be put on hold.
- Hold Recall**
If a call on hold is not retrieved within a preprogrammed time period (→ Hold Recall Time [200]), a ring tone will be heard at the extension that put the call on hold. If the extension is engaged in a call when the timer expires, an alarm tone will be heard. If the hold recall time is set to "Disable", no tone will be heard. Going off-hook after the hold recall time has expired automatically re-establishes the conversation with the call on hold.
- SLT Hold Mode**
It is possible to choose how to hold and transfer a call with an SLT, if the length of time that the Recall/hookswitch is pressed is shorter than a specified duration (→ Hookswitch Flash Timing Range [207]). The following methods (→ SLT Hold Mode [104]) are available:

Mode	Hold	Transfer to Extension
Hold-1	Pressing the Recall/hookswitch + Going on-hook	Pressing the Recall/hookswitch + Extension No.

Mode	Hold	Transfer to Extension
Hold-2	Pressing the Recall/hookswitch + Call Hold Feature No. + Going on-hook	Pressing the Recall/hookswitch + Extension No.
Hold-3	Pressing the Recall/hookswitch + Call Hold Feature No. + Going on-hook	Pressing the Recall/hookswitch + Call Hold Feature No. + Extension No.

In some cases, a call is not disconnected when an SLT user goes on-hook. Instead, the call is mistakenly placed on hold. After a specified time expires, the Hold Recall tone is heard. When the SLT user answers this, the user hears a cyclic tone (like a reorder tone). To avoid this problem, select "Hold-2" or "Hold-3". In either of these modes, all calls are disconnected when going on-hook, unless the Call Hold feature number is entered after pressing the Recall/hookswitch.

It is possible to set each SLT not to receive pulse signals through system programming (→ Internal Pulse Detection [614]). This setting helps the PBX to avoid mistaking pulse signals sent by dialling "1" for hooking, in the countries/areas where the length of time that the Recall/hookswitch is pressed is set to "MODE 1: 50–180 ms" in Hookswitch Flash Timing Range [207].

Feature Guide References

4.2.1 Tones/Ring Tones

User Manual References

1.4.2 Holding a Call

1.12.2 Call Park

Description

An extension user can hold a call by placing it into a common parking zone of the PBX. A parked call can be retrieved by any extension user. This feature is useful when an extension user wants to hold more than one intercom call with a proprietary telephone (PT), or more than one intercom call or outside (CO) line call with a single line telephone (SLT).

Conditions

- **Call Park Recall**
If a parked call is not retrieved within a preprogrammed time period (→ Hold Recall Time [200]), a ring tone will be heard at the extension that parked the call. If the destination is engaged in a call when the timer expires, an alarm tone will be heard.
- If a parked call is not retrieved within 30 minutes, it is automatically disconnected.
- **Retry**
If the specified parking zone is occupied, the extension user will hear a busy tone. While hearing a busy tone, the user can retry by selecting another parking zone.

User Manual References

1.4.2 Holding a Call

1.12.3 Call Splitting

Description

An extension user can speak alternately with 2 parties. Placing the current call on hold allows the user to speak with the other party.

Conditions

- This feature does not apply to calls from doorphones or paging announcements.
- **Consultation Hold**
When the extension user presses the HOLD button on a proprietary telephone (PT) or the Recall/hookswitch on a single line telephone (SLT), the held party is automatically placed on consultation hold (→ 1.12.5 Consultation Hold).

User Manual References

1.4.3 Talking to 2 Parties Alternately (Call Splitting)

1.12.4 Music on Hold

Description

An outside party on hold will hear audio to inform the party that the call is still on hold. The following types of audio are available depending on the user's country/area:

- a) Internal audio source
- b) External audio source
- c) Tone

The audio sources (internal and external) can also be used for BGM (→ 1.15.4 Background Music (BGM)).

Conditions

- **Hardware requirement:** A user-supplied audio device, such as a CD player or radio for External audio source.
- The audio can be selected through system programming (→ Music on Hold [111]).
- Operations such as Call Hold (→ 1.12.1 Call Hold) and Call Transfer (→ 1.11.1 Call Transfer) activate Music on Hold.

Installation Manual References

2.8.1 Connecting Peripherals

1.12.5 Consultation Hold

Description

When an extension user is on a call and performs Call Transfer (→ 1.11.1 Call Transfer), Call Splitting (→ 1.12.3 Call Splitting), or tries to establish a conference call (→ 1.13.1.2 Conference), the call is automatically placed on consultation hold. When the operation is completed or cancelled, the consultation hold is released.

1.13 Conference Features

1.13.1 Conference Features

1.13.1.1 Conference Features—OVERVIEW

Description

The following features are available to establish a conference call:

Feature	Description	Details in
Conference	An extension user can establish a 3-party or 5-party conference call.	• 1.13.1.2 Conference
Executive Busy Override	An extension user can interrupt an existing call to establish a 3-party conference call.	• 1.7.2 Executive Busy Override

1.13.1.2 Conference

Description

An extension user can establish a conference call. The following Conference features are available:

Feature	Description
3-party Conference	During a 2-party conversation, an extension user can add a third party to the conversation, thereby establishing a 3-party conference call. Unattended Conference: The proprietary telephone (PT) user who originated a conference with 2 outside parties can leave the conference and allow the other parties to continue the conversation. The user may return to the conference at any time, if he or she desires.
5-party Conference	A PT user can establish a 3-party to 5-party conference call by entering the 5-party Conference feature number.

Conditions

[General]

- **Conference call arrangement**
The following configurations of 3-party or 5-party conference calls are possible at the same time through system programming (→ Conference Pattern [116]):
 - 3-party conference calls between 3 extensions: Up to 3
 - 3-party conference calls between one extension and 2 outside parties: Up to 4
 - 3-party conference calls between 2 extensions and one outside party: Up to 4
 - 5-party conference call with up to 5 extensions or with a combination of extensions and up to 2 outside parties: One
- **Conference Button**
On a PT that does not have a CONF (Conference) button, a flexible CO button can be customised as a Conference button.
- **Consultation Hold**
When an extension user tries to establish a conference call, the current call is automatically placed on consultation hold until the conference is established (→ 1.12.5 Consultation Hold).

[3-party Conference]

- A confirmation tone will be sent to all parties when a 2-party conference call is changed to a 3-party conference call. It is possible to eliminate the tone through system programming (→ Conference Tone [105]).
- **Unattended Conference Recall**
The duration of unattended conferences is restricted by a system timer (→ CO-to-CO Line Call Duration [205]).
A ring tone or an alarm tone is heard at the conference originator's extension 50 seconds before the timer expires.
A warning tone starts to be heard by parties in the unattended conference 15 seconds before the timer expires.
If the originator returns to the conference before the unattended conference call is disconnected, the timer will be cancelled. If not, the ring tone or alarm tone and the warning tone will continue to be heard until the unattended conference call is disconnected (→ 1.10.8 Outside (CO) Line Call Limitation).

1.13 Conference Features

- An unattended conference cannot be established unless the extension is allowed to transfer a call to an outside party through system programming (→ Call Transfer to CO Line [606]).

[5-party Conference]

- The following features will not function during a 5-party conference call:
 - Call Hold
 - Call Park
 - Call Splitting
 - Call Transfer
 - Executive Busy Override
 - Unattended Conference
- A confirmation tone will be sent to all parties when a 5-party conference call is established and when a 5-party conference call is changed to a 4-party conference call or vice versa. It is possible to eliminate the tone through system programming (→ Conference Tone [105]).

Feature Guide References

1.18.1 Fixed Buttons

1.18.2 Flexible Buttons

User Manual References

1.4.5 Talking to Multiple Parties (Conference)

1.14 Paging Features

1.14.1 Paging

Description

An extension user can make a paging announcement to several people at once. The announcement is heard through the built-in speakers of proprietary telephones (PTs) and/or an external pager (loudspeaker), depending on the type of Paging that is performed as follows:

Type	Paging method
All Extensions	The page is heard through the built-in speakers of all PTs.
External	The page is heard through an external pager.
Group	The page is heard through the built-in speakers of the PTs that belong to a certain extension group (→ Extension Group [600]).
All Extensions & External	The page is heard through the built-in speakers of all PTs and an external pager simultaneously.

The paged person can answer the page from a nearby telephone. It is possible to page with a call on hold in order to transfer the call.

Paging Deny

It is possible for each extension to deny being paged.

Conditions

- **Hardware Requirement:** A user-supplied external pager.
- A confirmation tone will be sent to the external pager before the paging announcement. It is possible to eliminate the tone through system programming (→ External Pager Access Tone [106]).
- Only one person can use this feature at a time.
- Extensions that cannot be paged are:
 - Ringing or busy PTs
 - PTs in Paging Deny mode
 - PTs in DND mode (→ 1.3.1.3 Do Not Disturb (DND))

Installation Manual References

2.8.1 Connecting Peripherals

User Manual References

1.6.1 Paging

1.6.2 Answering/Denying a Paging Announcement

1.15 Optional Device Features

1.15.1 Doorphone Call

Description

A visitor can use a doorphone to call its preprogrammed destination. Extension users can call a doorphone. Doorphones can also be used for the Room Monitor feature (→ 1.10.2 Room Monitor).

Conditions

- **Hardware Requirement:** An optional doorphone, and doorphone card.
- When an optional 4-port doorphone card is installed in the PBX, doorphones 1 and 2 (or doorphones 3 and 4) cannot be used at the same time. When one is in use, the user cannot have a conversation with the other.
- A doorphone access tone will be sent to a monitored doorphone before monitoring starts. If an extension user wants to monitor a doorphone without informing the other party, it is possible to eliminate the tone through system programming (→ Doorphone Access Tone [707]).
- **Ring Duration**
If an incoming doorphone call is not answered within a preprogrammed time period (→ Doorphone Ring Time [708]), ringing stops and the call is cancelled.
An extension user can choose the preferred ring tone pattern for doorphone calls through system programming (→ Doorphone Ring Tone Pattern [706]).
- **Call Destination**
System programming determines the extensions that can receive calls from each doorphone for each time service mode (→ Doorphone Ringing—Day/Night/Lunch [700-702]).
- **Door Open**
While on a doorphone call, an extension user can unlock the door to let the visitor in (→ 1.15.2 Door Open).
- When a doorphone call is received at a proprietary telephone (PT), a tone is heard instead of ringing.

Installation Manual References

- 2.3.6 2-Port Doorphone Card (KX-TE82460)
- 2.3.7 4-Port Doorphone Card (KX-TE82461)
- 2.6 Connecting Doorphones and Door Openers

Feature Guide References

- 4.2.1 Tones/Ring Tones

User Manual References

- 1.8.1 If a Doorphone/Door Opener is Connected

1.15.2 Door Open

Description

Using an extension telephone, an extension user can unlock a door for a visitor.

The door can be unlocked by extension users who are allowed through system programming to unlock the door for each time service mode (→ Door Opener—Day/Night/Lunch [703-705]). While on a doorphone call, any extension user can unlock a door to let a visitor in (→ 1.15.1 Doorphone Call).

Conditions

- **Hardware Requirement:** A user-supplied door opener installed on each door, optional doorphone, and doorphone card.
- A door opener can unlock a door even if no doorphone is installed.
- **Door Open Duration**
An opened door will remain unlocked for a preprogrammed length of time (→ Door Open Duration [709]).

Installation Manual References

- 2.3.6 2-Port Doorphone Card (KX-TE82460)
- 2.3.7 4-Port Doorphone Card (KX-TE82461)
- 2.6 Connecting Doorphones and Door Openers

User Manual References

- 1.8.1 If a Doorphone/Door Opener is Connected

1.15.3 Doorbell/Door Chime

Description

Extension users can choose how their telephones receive doorphone calls, by selecting to hear ringing, a chime, or both, provided a doorbell/door chime connected to a door opener is connected to the PBX. They can recognise which doorphone is ringing by selecting a different doorphone chime pattern for each doorphone.

[Programming Example]

In order for an extension connected to extension jack 01 (extension 101) to be able to receive a doorphone call from a doorbell/door chime connected to Relay 4, programme as follows:

Programming	Doorphone			
	1	2	3	4
Doorphone Ringing *1	Enable (extn. 101)	Enable (extn. 101)	Enable (extn. 101)	Enable (extn. 101)
Doorphone Ring/Chime *2	Chime	Chime	Chime	Chime
Doorphone Chime Assignment *3	Relay 4	Relay 4	Relay 4	Relay 4
Doorphone Chime Pattern *4	Pattern 1	Pattern 2	Pattern 3	Pattern 4

*1 → Doorphone Ringing—Day/Night/Lunch [700-702]

*2 → Doorphone Ring/Chime [710]

*3 → Doorphone Chime Assignment [711]

*4 → Doorphone Chime Pattern [712]

In this example

When a visitor presses the Call button of Doorphone 2:

- A doorbell/door chime, connected to Relay 4, chimes with Pattern 2.
- Because Doorphone Ring/Chime is set to "Chime", extension 101 does not ring.
- The extension user who is allowed to receive a call from Doorphone 2 can answer the doorphone call by going off-hook within a preprogrammed time period (→ Doorphone Ring Time [708]). If the user is allowed to unlock the door (→ Door Opener—Day/Night/Lunch [703-705]), he or she can then unlock the door by entering the Door Open feature number.
- If the called extension is busy and has set Call Waiting, the extension user hears a call waiting tone and the call information flashes on the display.

Conditions

- **Hardware Requirement:** A user-supplied doorbell/door chime connected to each door opener.

Installation Manual References

2.7 Connecting Doorbell or Door Chime

Feature Guide References

4.2.1 Tones/Ring Tones

User Manual References

1.8.1 If a Doorphone/Door Opener is Connected

1.15.4 Background Music (BGM)

Description

A proprietary telephone (PT) user can listen to background music (BGM) through the built-in speaker while on-hook and idle.

Conditions

- **Hardware requirement:** A user-supplied external audio device, such as a CD player or radio for External audio source.
- The music heard through the PT is interrupted when going off-hook, receiving a call, or receiving a paging announcement.
- The audio can be selected through system programming (→ Music on Hold [111]).
- This feature can be turned on and off by dialling "1" while the extension is on-hook and idle, if BGM is enabled through system programming (→ BGM Control for APT [626]).

Installation Manual References

2.8.1 Connecting Peripherals

User Manual References

1.7.5 Turning on the Background Music (BGM)

1.15.5 Outgoing Message (OGM) for DISA/UCD

Description

An extension assigned as the operator or manager extension can record outgoing messages (OGMs) for the following features:

Feature	Usage	Details in
Direct Inward System Access (DISA)	When a call arrives on a DISA line, the caller will hear a DISA OGM.	• 1.15.6 Direct Inward System Access (DISA)
3-level Automated Attendant (AA)	When the DISA AA service is active, the caller will hear a DISA OGM. The DISA AA service supports up to 3 levels of DISA OGMs.	• 1.15.6 Direct Inward System Access (DISA)
Uniform Call Distribution (UCD)	When a call arrives at a UCD group and all extensions in the group are busy, the caller will hear a UCD OGM (→ UCD Waiting Message [527]).	• 1.2.2 Uniform Call Distribution (UCD)

Conditions

- This feature functions differently from personal/common BV OGMs used by the BV feature (→ 1.15.7 Built-in Voice Message (BV)).
- To use this feature, "DISA" or "UCD" must be selected as the distribution method for the desired outside (CO) line port (→ CO Line Mode—Day/Night/Lunch [414-416]).
- The operator or manager can record a maximum of 32 messages (8 messages for DISA/UCD and 24 messages for 3-level AA). When an optional message expansion card for DISA/UCD OGMs is added, up to 2 messages can be played simultaneously for callers, and the total recording time of the PBX is increased from 3 to 6 minutes.
- After recording messages, the operator or manager can also play them back for confirmation. In addition, the operator or manager can erase messages for DISA/UCD.
- When the operator or manager tries to record or play back a message, he or she will hear an alarm tone if the message channel is in use.
- Prerecorded messages will not be cleared by a system restart. To clear them, use system programming (→ Clear All OGMs of DISA/UCD [599]).

Installation Manual References

2.3.8 Message Expansion Card for DISA/UCD OGMs (KX-TE82491)

User Manual References

2.1.7 Changing System Settings Using Programming Mode

1.15.6 Direct Inward System Access (DISA)

Description

Direct Inward System Access (DISA) allows outside callers to be connected to their desired PBX destinations without the use of the operator. Callers can listen to a DISA outgoing message (OGM) instructing them as to which numbers to dial to be connected to the person or department they would like to speak with. DISA can also give PBX users access to PBX features, such as making outside (CO) line calls, when they are outside the office.

This DISA OGM can guide callers and allow them to:

- Call an extension by dialling the extension number.
- Call another outside party via the outside (CO) lines of the PBX.
- Access the desired extension simply by dialling a single-digit number (DISA Automated Attendant [AA] number) using DISA AA service.

DISA OGM

When a call arrives on a DISA line, callers will hear a DISA OGM or a short beep. When the DISA AA service is active, this DISA OGM will direct callers to dial the appropriate digit (DISA AA number) to be connected to a specified destination. To access other PBX features, such as making intercom or outside (CO) line calls, the caller may dial the appropriate numbers while the DISA OGM is playing.

An extension assigned as the operator or manager extension can record a DISA OGM (→ 1.15.5 Outgoing Message (OGM) for DISA/UCD).

DISA AA Service

DISA AA service allows a caller to dial a single-digit number (DISA AA number) and be connected to the desired party automatically. The PBX can store up to 10 destinations that can be called by dialling a DISA AA number (0–9) for each DISA OGM (→ DISA Built-in AA [501]). These destinations can be an extension number (→ Extension Number [009]), an extension group number (→ Extension Group [600]), or the DISA AA number of a 3-level DISA OGM (→ 3-level AA Assignment [540-549]).

During or after the DISA OGM announcement (→ DISA Wait Time after OGM [505]), or after a short beep (→ Intercept Time for Internal DISA [515]), the caller may dial a DISA AA number as directed by the DISA OGM (e.g., "Press 1 to speak to Sales. Press 2 to speak to Support.").

Each DISA AA number directs the call to a preprogrammed location.

Since DISA AA numbers are single digits, if the caller dials a second digit within a preprogrammed time period (→ DISA AA Wait Time [517]), DISA AA service will be bypassed because the PBX will assume the caller is trying to access a specific feature.

When the DISA AA service is used, Incoming Dial Mode must be set to "With AA" through system programming (→ DISA Incoming Call Dial Mode [500]). When "With AA" is selected, the PBX regards caller-dialled digits "0" through "9" as DISA AA numbers. If no destination is assigned to "9" or "0", the PBX regards the number (9/0)* as the Automatic Line Access number (→ Automatic Line Access [121]) or Operator Call number.

Note

* For New Zealand, the Automatic Line Access number may be either 1 or 9.

[Programming Example: 1-level (DISA) AA Table]

In order for a caller to be able to access Mike Smith (extension 102) using 1-level (DISA) AA, programme as follows:

Outside (CO) Line No.	Distribution method* ¹		
	Day	Lunch	Night
1, 2	DISA OGM1	DISA OGM1	DISA OGM1
3–8	Normal	Normal	Normal

DISA AA No. for 1-level AA* ²									
0	1	2	3	4	5	6	7	8	9
–	Mike Smith (102)	Extn. 103	Extn. 104	Extn. 105	Extn. 106	Extn. 107	Extn. 108	Extn. Group 1	–

*¹ → CO Line Mode—Day/Night/Lunch [414-416]

*² → DISA Built-in AA [501]

[Programming Example: 3-level AA Table]

In order for a caller to be able to access Mike Smith of the Software Support Team (extension 102) using 3-level AA, programme as follows:

Outside (CO) Line No.	Distribution method* ¹		
	Day	Lunch	Night
1–4	DISA OGM1	DISA OGM2	DISA OGM3
5–8	Normal	Normal	Normal

1.15 Optional Device Features

1-level AA

DISA AA No.*2									
0	1	2	3	4	5	6	7	8	9
–	Extn. Group 1	Extn. Group 2	2-level AA*3	–	–	–	–	–	–

2-level AA

DISA AA No.*4						
0	1	2	3	4	5	6
–	Extn. Group 3	3-level AA*5	Extn. Group 4	–	–	–

3-level AA

DISA AA No.*4						
0	1	2	3	4	5	6
Extn. 101	Mike Smith (102)*6	–	–	–	–	–

*1 → CO Line Mode—Day/Night/Lunch [414-416]

*2 → DISA Built-in AA [501]

*3 2-level AA: Select "3-level AA" for AA number "3" in DISA Built-in AA [501]

*4 → 3-level AA Assignment [540-549]

*5 3-level AA: Select "3-level AA" for "second AA number 2" and for "third AA number ✕" in the [543] of 3-level AA Assignment [540-549]

*6 Mike Smith (102): Select "Jack 02" for "second AA number 2" and for "third AA number 1" in the [543] of 3-level AA Assignment [540-549]

In this example:

- 1) After or while listening to the AA first-level DISA OGM (e.g., "Press 1 to speak to Sales. Press 2 to speak to Service. Press 3 to speak to Support."), caller dials a DISA AA number, "3", as directed by the DISA OGM.
- 2) Next, the AA second-level DISA OGM (e.g., "Press 1 to speak to Hardware Team. Press 2 to speak to Software Team.") directs the caller to dial another DISA AA number. The caller dials "2".
- 3) Finally, the AA third-level DISA OGM (e.g., "Press 1 to speak to Mike Smith. Press 0 to speak to the Operator.") directs the caller to dial a DISA AA number, "1", to be connected to a specified destination, extension 102.

Note

When the type of a destination from 2-level AA or 3-level AA to another setting is changed, any associated DISA OGM will also be cleared. In addition, any items within the AA menu being removed will also be removed.

DISA Busy Mode

If the destination of a DISA call is busy, the call will be redirected to an idle extension (→ Hunting Group Set [100]) in the destination's idle extension hunting group (→ 1.2.1 Idle Extension Hunting). If no extension in the group is available, or if the destination of the DISA call is not a member of an idle extension hunting group, the call will be handled in one of the following ways, according to system programming (→ DISA Busy Mode [506]):

- a) **Disconnect:** The caller hears a busy tone and the call is disconnected.
- b) **Call Waiting:** The called extension hears a call waiting tone if the extension has set Call Waiting.
- c) **DISA:** The following procedure is performed:
 - 1) If the assigned DISA OGM (busy message) has been recorded, the caller hears the DISA OGM (e.g., "The party you called is unavailable..."). If the assigned DISA OGM has not been recorded, the caller hears a busy tone and the call is disconnected.
 - 2) After the busy message has been played, the DISA OGM that was sent before the busy message is sent to the caller again.
 - 3) The PBX waits for the caller to enter a new destination. In this case, the PBX does not accept any Outside (CO) Line Access number regardless of the security type.

If the destination is a member of a DISA ring group, DISA Busy Mode will not function for the call. The PBX regards it as unanswered.

DISA Intercept Mode

If the destination of a DISA call does not answer the call within a preprogrammed time period (→ DISA Ring Time before Intercept [508]), the call will be handled in one of the following ways, according to system programming (→ DISA Intercept Mode [507]):

- a) **Disconnect:** The call is disconnected.
- b) **Intercept:** The call is redirected to preprogrammed intercept destinations in the following priority: DISA IRNA to BV—Day/Night/Lunch [438-440] → Flexible Ringing—Day/Night/Lunch [408-410]. This is useful for business calls. For example, the call can be forwarded to the operator, a Voice Processing System (VPS) or Built-in Voice Message (BV) automatically.

DISA No Dial Mode

If the PBX does not receive either DTMF (Dual Tone Multi-Frequency) signals or a fax (CNG) tone within a preprogrammed time period (→ DISA Wait Time after OGM [505]), or if the PBX does not receive DTMF signals within a preprogrammed time period (→ Intercept Time for Internal DISA [515]), the call will be handled in one of the following ways, according to system programming (→ DISA No Dial Mode [510]):

- a) **Disconnect:** The call is disconnected.
- b) **Intercept:** The call is redirected to preprogrammed intercept destinations in the following priority: DISA IRNA to BV—Day/Night/Lunch [438-440] → Flexible Ringing—Day/Night/Lunch [408-410]

DISA Security Mode

Security can be enabled for the PBX to control the types of calls that can be made by callers using DISA. When the DISA security mode is set to "All Security" or "Trunk Security" (→ DISA Security Mode [511]), a caller is required to enter a DISA security code (→ DISA Security Code [512]) before making intercom and outside (CO) line calls, or outside (CO) line calls only, respectively. The DISA security code and the number of digits required for the DISA security code (→ DISA Security Code Digits [530]) can be assigned by the manager. After entering a DISA security code, if the code is the same as one of the preprogrammed security codes, the caller will hear a short beep. It is possible to eliminate the tone through system programming (→ DISA Tone after Security Code [518]).

If the DISA security code is entered incorrectly 3 times when using DISA, a reorder tone will be sent to the caller and the call will be disconnected.

1.15 Optional Device Features

Security Mode	Intercom Calls	Outside (CO) Line Calls
All Security		
Trunk Security	✓	
No Security	✓	✓

✓ Permitted

Outside-to-Outside (CO-to-CO) Line Calls through DISA

DISA callers can use DISA to make outside (CO) line calls when allowed by the DISA security mode.

If a call between 2 outside parties is established via DISA, the length of the call can be limited to a preprogrammed duration (→ CO-to-CO Line Call Duration [205]). A timer will activate when the call is connected, and a warning tone will be heard 15 seconds before the timer expires. When the timer expires, the call is disconnected (→ 1.10.8 Outside (CO) Line Call Limitation).

To detect the end of an outside-to-outside (CO-to-CO) line call, Calling Party Control (CPC) Signal Detection can be assigned through system programming (→ CPC Signal Detection—Incoming [420], CPC Signal Detection—Outgoing [421]).

[Flowchart]

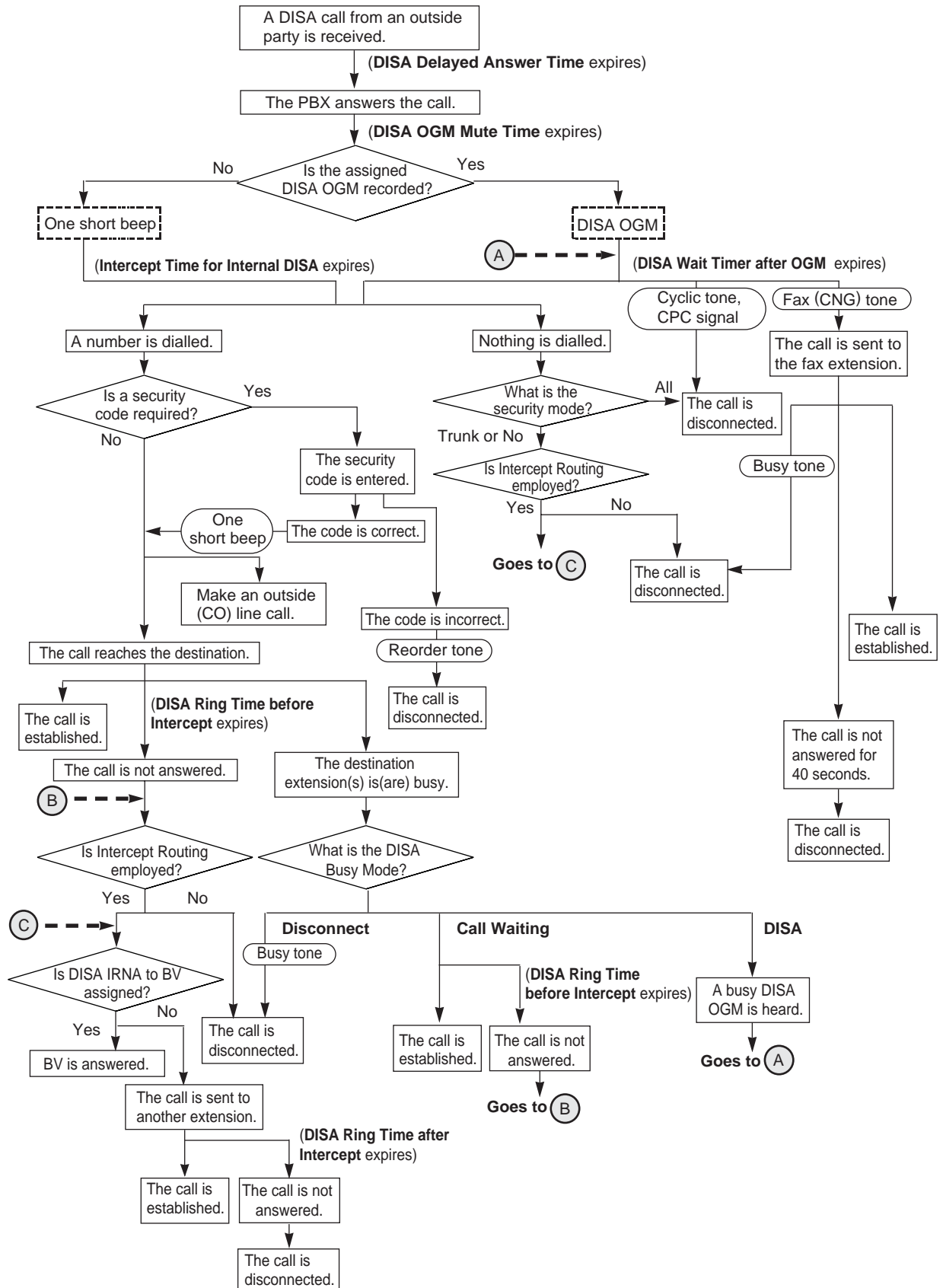

Conditions

WARNING

There is a risk that fraudulent telephone calls will be made using the Outside-to-Outside (CO-to-CO) Line Call feature of DISA.

The cost of such calls will be billed to the owner/renter of the PBX.

To protect the PBX from this kind of fraudulent use, we strongly recommend:

- a) Enabling DISA security (Trunk Security or All Security).**
- b) Maintaining the secrecy of passwords.**
- c) Selecting passwords that are complex and random, so that they cannot be easily guessed.**
- d) Changing passwords regularly.**

- The maximum recording time of each message is 3 minutes.
- The preinstalled DISA/UCD OGM card can play only one message at a time and the total recording time of the PBX for DISA/UCD OGMs is 3 minutes. When an optional message expansion card for DISA/UCD OGMs is added, up to 2 messages can be played simultaneously for callers, and the total recording time of the PBX is increased to 6 minutes.
- To use this feature, "DISA" must be selected as the distribution method for the desired outside (CO) line port (→ CO Line Mode—Day/Night/Lunch [414-416]).
- **DISA Delayed Answer Time**
It is possible to set the DISA Delayed Answer time (→ DISA Delayed Answer Time [504]) so that the caller will hear a ringback tone for a preprogrammed length of time before hearing a DISA OGM or a short beep.
- **Call Forwarding (FWD) to Outside (CO) Line**
When a DISA call is forwarded to an outside party, the caller is not required to enter a DISA security code regardless of the security mode.
- **DISA OGM Mute Time**
Certain DTMF signals, such as Caller ID information, may be sent from the telephone company when a call is first connected. Because these signals may interfere with DISA, the PBX can be programmed to ignore DTMF signals for a specified amount of time (→ OGM Mute Time [519]) after a call is connected. After the DISA OGM Mute Time passes, DTMF signals are recognised by the PBX and the DISA OGM begins playing or a short beep is sent.
- **SMDR**
The following are logged by SMDR for DISA calls (→ 1.20.1 Station Message Detail Recording Feature):
 - The destination of the DISA call
 - DISA security code status
- **Call Deny**
System programming determines which extensions can receive DISA calls (→ DISA Incoming Assignment [516]). If a DISA call is received at an extension that has Call Deny set, the caller will hear a reorder tone and the call will be disconnected automatically. If a DISA call is received by a DISA ring group, this programme does not function for extensions in that DISA ring group and these extensions will still ring.
- **Cyclic Tone Detection**
It is possible to select the number of times a cyclic tone must be detected while the DISA OGM is sent (→ Cyclic Tone Detection [513]). Cyclic Tone Detection can be used to disconnect an outside-to-outside (CO-to-CO) line call via DISA.
- **Fax Connection**
System programming determines the extensions that are able to receive fax data when the PBX receives a fax (CNG) tone via the DISA feature (→ FAX Connection [503]). The preprogrammed extension will automatically have the Data Line Security feature set.

- **Fax Tone Detection**

It is possible to select the number of times the fax (CNG) tone must be detected while the DISA OGM is sent before the PBX recognises the incoming signal as fax data (→ FAX Tone Detection [514]). If the DISA OGM is short (0–5 s), in some cases the fax (CNG) tone may not be detected. In this case, it is recommended to set the length of time the PBX continues to search for a fax (CNG) tone after completing a DISA OGM to "10 s" or "15 s" through system programming (→ DISA Wait Time after OGM [505]). If the assigned DISA OGM has not been recorded, it is recommended to set the length of time to "6 s" or "9 s" through system programming (→ Intercept Time for Internal DISA [515]).

- It is programmable whether a ringback tone (→ Ringback Tone Pattern [128]) or Music on Hold (→ Music on Hold [111]) is sent to the caller when a DISA call is received (→ DISA Ringback Tone [531]).

Installation Manual References

2.3.8 Message Expansion Card for DISA/UCD OGMs (KX-TE82491)

Feature Guide References

1.1.1.2 Intercept Routing

1.15.7 Built-in Voice Message (BV)

User Manual References

1.2.7 Accessing Another Party Directly from Outside (Direct Inward System Access [DISA])

3.3.1 Programming Information

1.15.7 Built-in Voice Message (BV)

Description

If an optional voice message card is installed in the PBX, a caller can leave a voice message in a user's personal message area or the PBX's common message area. Information on the recorded messages is automatically logged in the Incoming Call Log of the extension, where it can be viewed later or used to play back the original message (→ 1.16.2 Incoming Call Log). The optional voice message card has 2 voice message resources (Built-in Voice Message [BV] resource 1 and BV resource 2), and every extension must belong to one of these resources based on system programming (→ BV Resource [621]).

Extension users other than the operator or manager can access the following options:

- Personal BV outgoing messages (OGMs)
- Personal voice messages (left by callers via Call Forwarding [FWD] or Direct Message)

Messages can be recorded, played, and erased by that extension's user.

The operator or manager can access the following options:

- Personal BV OGMs for the operator or manager
- Personal voice messages (left by callers via FWD or Direct Message for the operator or manager)
- Common BV OGMs for the company
- Common voice messages (left by callers for the company)

Messages can be recorded, played, and erased by the operator or manager only.

Up to 125 voice messages with a total recording time of 60 minutes (→ BV Total Recording Time [807]) can be logged per BV resource. All personal/common message areas within each BV resource share the total space of the resource. For example, in BV resource 1, if the common message area currently has 10 messages, totalling 10 minutes, the personal and common message areas can jointly store up to 115 messages or 50 minutes.

[Example: Pattern A]

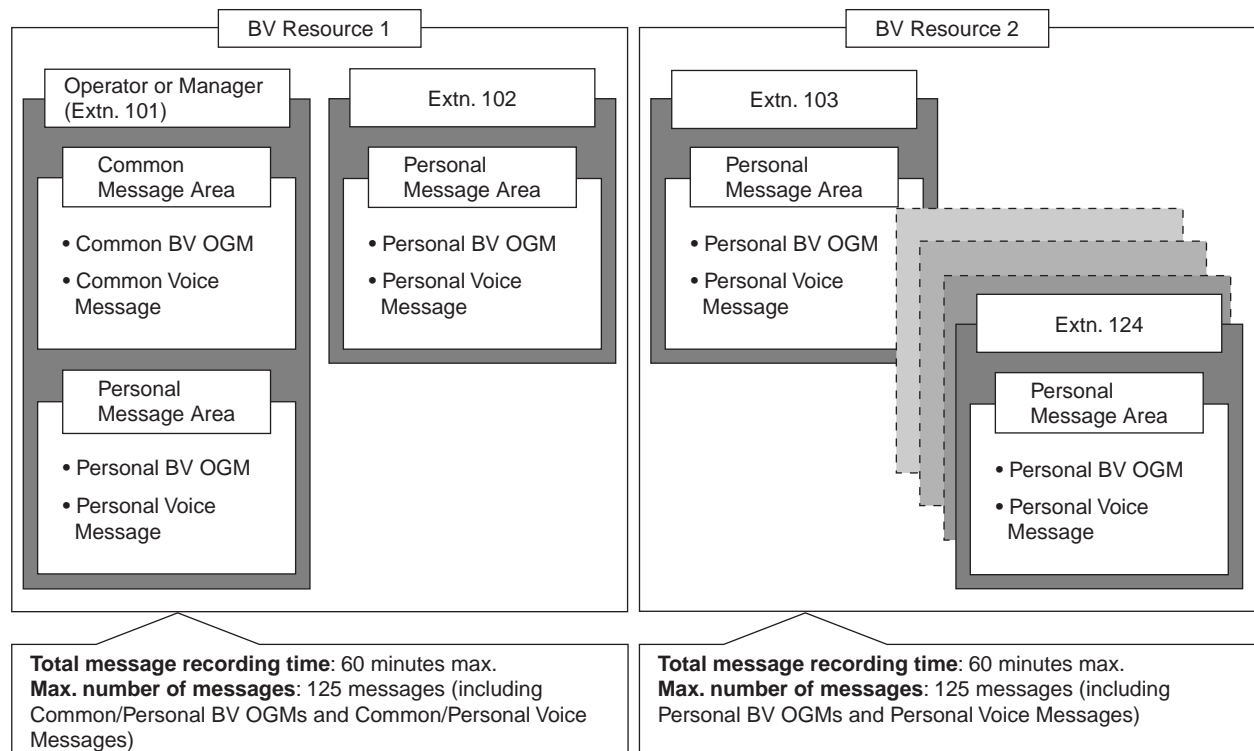

[Example: Pattern B]

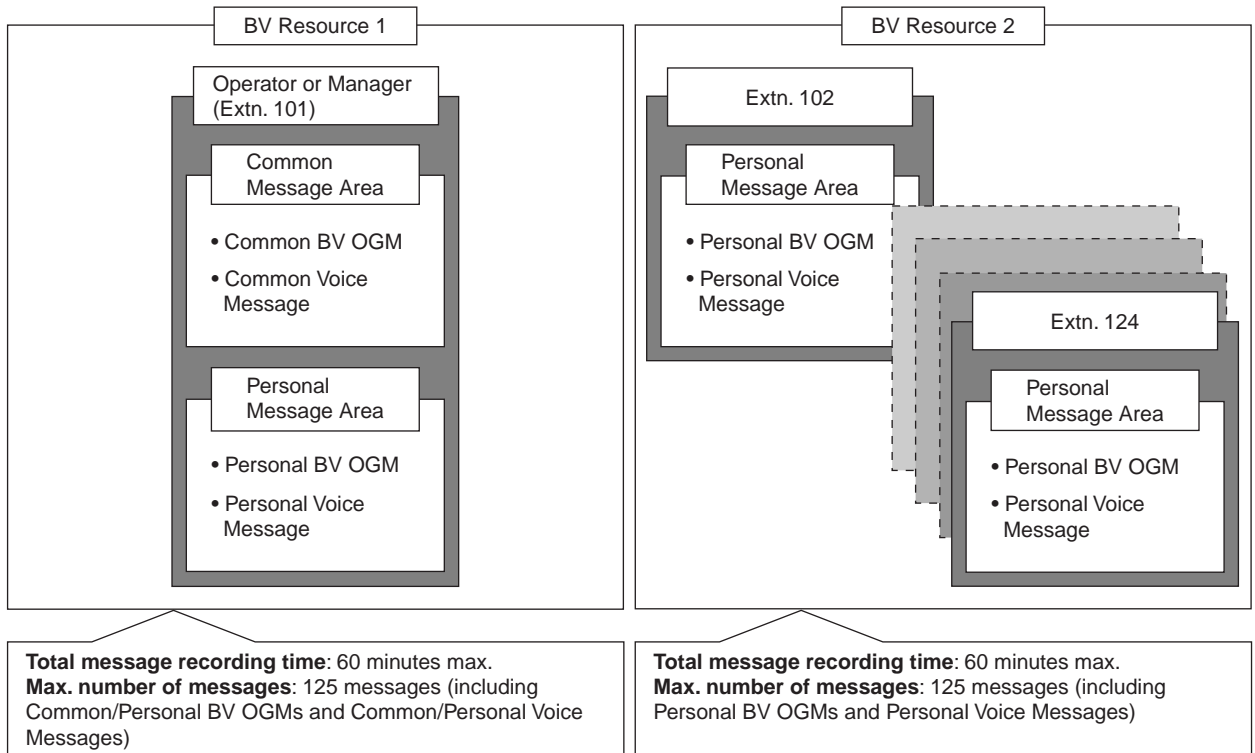

[Example: Pattern C]

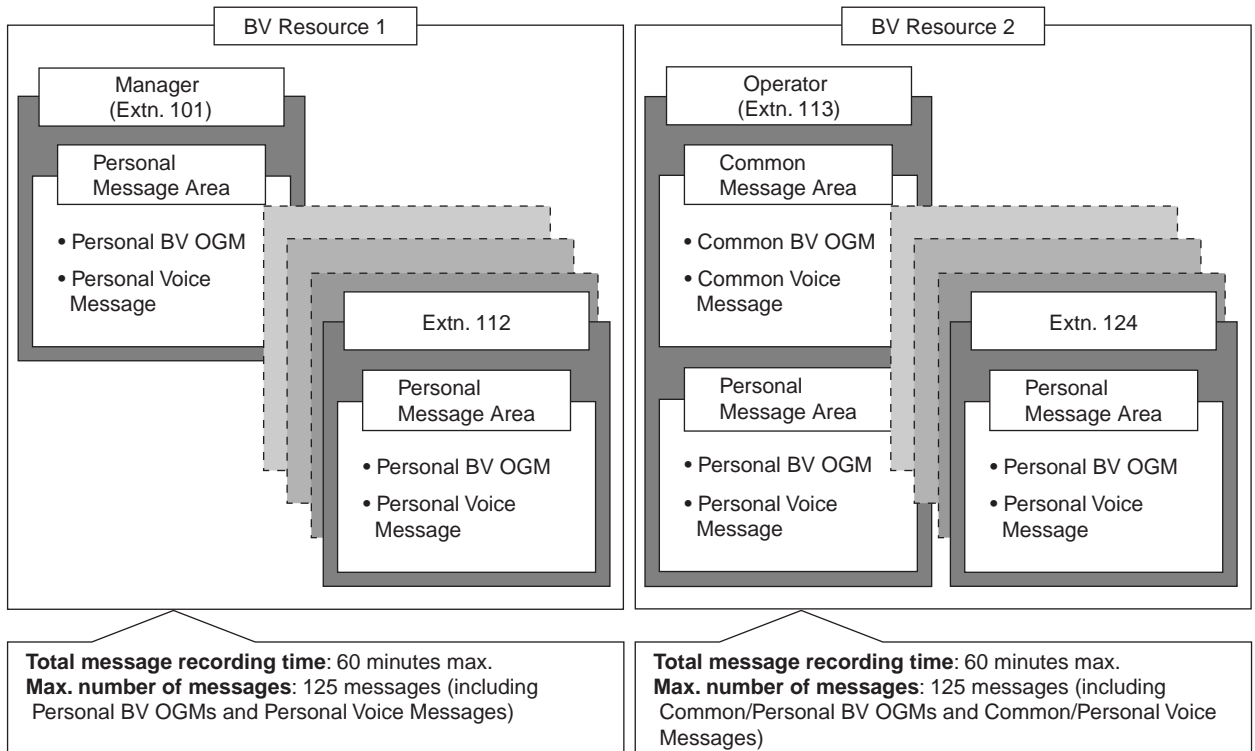

If there are new voice messages in a user's personal message area or the common message area (if accessible), the user will hear a special dial tone (dial tone 4) when going off-hook. In addition, if that user's telephone has a MESSAGE button or Message/Ringer Lamp, the corresponding button or lamp will light

1.15 Optional Device Features

when a message has been left. A MESSAGE button can be used to listen to the message after the user goes off-hook. Pressing the lit MESSAGE button on a display proprietary telephone (PT) while on-hook shows voice message information.

The BV feature allows users to also perform the following operations:

- If outside (CO) line calls are preprogrammed to be automatically directed to a common message area (→ CO Line Mode—Day/Night/Lunch [414-416]), or if Direct Inward System Access (DISA) calls are preprogrammed to be redirected to a common message area via Intercept Routing (→ DISA IRNA to BV—Day/Night/Lunch [438-440]), the caller will hear a common BV OGM and can leave a voice message directly in the common message area.

[Programming Example]

Outside (CO) Line No.	Distribution method*1			DISA IRNA to BV*2		
	Day	Night	Lunch	Day	Night	Lunch
1	BV01*3	BV02*3	BV02*3	Not Stored	Not Stored	Not Stored
2	DISA OGM3	DISA OGM4	Normal	BV20*3	BV21*3	Not Stored
(Cont.) :	:	:	:	:	:	:
:	:	:	:	:	:	:
8	Normal	Normal	Normal	Not Stored	Not Stored	Not Stored

*1 → CO Line Mode—Day/Night/Lunch [414-416]

*2 → DISA IRNA to BV—Day/Night/Lunch [438-440]

Note

This feature functions only when "DISA" is selected as the distribution method for the corresponding outside (CO) line port.

*3 BVxx (xx=01–24): Common BV OGM number followed by the Common BV OGM feature number "722"

In this example:

If an outside (CO) line call is received on outside (CO) line 1:

- In day mode: The common BV OGM to be played ("BV01") for BV distribution is assigned. The caller hears the specified common BV OGM and leaves a voice message in the common message area.
- In night/lunch mode: The common BV OGM to be played ("BV02") for BV distribution is assigned. The caller hears the specified common BV OGM and leaves a voice message in the common message area.

If an outside (CO) line call is received on outside (CO) line 2:

- In day mode: The DISA OGM to be played ("DISA OGM3") for DISA distribution and the common BV OGM to be played ("BV20") for DISA IRNA to BV are assigned. The call arrives on a DISA line and the caller hears the specified DISA OGM. When the destination does not answer the DISA call, the call is redirected to the common message area via Intercept Routing. The caller hears the specified common BV OGM and leaves a voice message in the common message area.
- In night mode: The DISA OGM to be played ("DISA OGM4") for DISA distribution and the common BV OGM to be played ("BV21") for DISA IRNA to BV are assigned. The call

arrives on a DISA line and the caller hears the specified DISA OGM. When the destination does not answer the DISA call, the call is redirected to the common message area via Intercept Routing. The caller hears the specified common BV OGM and leaves a voice message in the common message area.

- An extension user can set incoming calls to be forwarded to his or her personal message area, when he or she cannot answer them. If an incoming call, direct to the user's extension, or a call using the DISA AA service (→ CO Line Mode—Day/Night/Lunch [414-416]), is forwarded to the user's personal message area, the caller will hear a personal BV OGM and can leave a voice message.
- **Direct Message feature**
An extension user can leave a voice message directly in the personal message area of another extension, even if the extension has not been set to forward incoming calls to its personal message area, or even if no personal BV OGM has been recorded. When a caller leaves a voice message using this feature, the voice message is automatically linked to the caller information (including the extension number and name [if stored]) in the Incoming Call Log.
- An extension user can play and/or erase voice messages from the user's extension. In addition, a user or the operator/manager can remotely play and/or erase voice messages through an outside (CO) line. The relevant voice message area is accessed by entering a preprogrammed voice message access code (→ BV Access Code through CO Line [625]) while hearing a personal/common BV OGM or DISA OGM.

Note

If the Voice Mail Integration feature has been set, the BV feature will not function.

Conditions

- **Hardware Requirement:** An optional voice message card.
- The BV feature does not use OGMs for DISA/Uniform Call Distribution (UCD) on either the preinstalled DISA/UCD OGM card or the optional message expansion card for DISA/UCD OGMs (if present) (→ 1.15.5 Outgoing Message (OGM) for DISA/UCD).
- When an extension that belongs to BV resource 1 or BV resource 2 is reassigned to the other resource, the voice messages that were recorded prior to reassignment are erased, but the personal/common BV OGMs are not erased.
- Each resource can only be accessed by one extension at a time. When the resource an extension is assigned to is being used by another extension, the extension cannot use that resource, even if the other resource is available.
- The PBX can record a maximum of 125 voice messages per resource. The maximum recording time of each voice message (→ BV Recording Time [214]) and the total recording time of the PBX (→ BV Total Recording Time [807]) are programmable. The maximum recording time of each personal/common BV OGM (→ Common/Personal BV OGM Recording Time [215]) is also programmable.
- System programming determines the extension users that can use this feature (→ BV for Extension [622]).
- If a voice message channel (resource) is in use when an outside caller tries to leave a voice message, he or she will hear a ringback tone. The caller will hear a personal/common BV OGM as soon as a channel becomes available. Up to 8 outside (CO) line calls can be placed in a queue as they arrive.
- If a user performs System Data Clear by selecting "All para" through system programming (→ System Data Clear [999]), all voice messages except for personal/common BV OGMs are erased. To erase all voice messages and personal/common BV OGMs at once, initialise the voice message card through system programming (→ BV Card Initialisation [808]).
- Even if no flexible CO button is assigned as a Caller ID Indication—Personal button or a Caller ID Indication—Common button, a caller can leave a voice message in that personal/common message area and the Caller ID information, including associated voice messages will be logged.

1.15 Optional Device Features

- When the remaining recording time for the PBX is less than 5 minutes, the display informs both the extension users within the same resource and the manager that the voice message resource is full, and the users will hear a special dial tone (dial tone 5) when going off-hook. If the remaining recording time goes back to being 5 minutes or more, for example, when messages are erased, the display returns to the idle status display and the users will hear another dial tone instead of dial tone 5 when going off-hook.
- If the FWD feature is enabled for an extension whose FWD destination is the BV feature number (→ Call Forwarding Selection [963]) and the extension has been assigned as "Normal" (→ CO Line Mode—Day/Night/Lunch [414-416]), outside (CO) line calls to the extension will not be forwarded and the extension will not ring, even if the user has set the FWD feature. If FWD is disabled, outside (CO) line calls to the extension will not be forwarded and the extension will ring.
- Only the operator or the manager can access the common message area (including common BV OGM). The operator has higher priority than the manager as follows:
 - When the operator extension is reassigned, the common voice messages (except for the personal BV OGM of the operator) that were recorded prior to reassignment are erased. The new operator can record, play back, and erase the common BV OGM.
 - When the operator, who does not share an extension number with the manager, is newly assigned, the common voice messages (except for the personal BV OGM of the manager) that were recorded prior to reassignment are erased. The operator can record, play back, and erase the common BV OGM.
 - When the operator, who does not share an extension number with the manager, is deleted, the common voice messages (except for the personal BV OGM of the operator) that were recorded prior to reassignment are erased. In this case, the manager can record, play back, and erase the common BV OGM.
- A voice message area cannot be included as a member of a conference call.
- Even if a caller does not leave a voice message in either the personal or common message area, for example, by going on-hook while hearing a personal/common BV OGM, the information is still logged in the corresponding Incoming Call Log (common or personal area) and displayed by SMDR (→ 1.20.1 Station Message Detail Recording Feature).
- **Personal/Common BV OGM Mute Time**
Certain DTMF signals, such as Caller ID information, may be sent from the telephone company when a call is first connected. Because these signals may interfere with BV, the PBX can be programmed to ignore DTMF signals for a specified amount of time (→ OGM Mute Time [519]) after a call is connected. After the Personal/Common BV OGM Mute Time passes, DTMF signals are recognised by the PBX and the personal/common BV OGM begins playing.
- A PT user can listen to voice messages by entering the Message Waiting Answer feature number.

Installation Manual References

2.3.9 2-Channel Voice Message Card (KX-TE82492)

Feature Guide References

1.15.6 Direct Inward System Access (DISA)

4.2.1 Tones/Ring Tones

User Manual References

1.5.5 Using Voice Messaging (Built-in Voice Message [BV])

2.1.6 Recording, Playing, or Erasing Common BV Outgoing Messages

1.16 Caller ID Features

1.16.1 Caller ID

Description

The PBX can receive Caller ID information (telephone numbers and callers' names) from calls received on outside (CO) lines. This information can be shown on the displays of proprietary telephones (PTs) as well as some single line telephones (SLTs) when receiving calls. Additionally, Caller ID information is logged in the Incoming Call Log of the extension that received the call, allowing the caller to view a record of incoming calls or make a call to a person in the call log later.

The PBX can be programmed to modify a caller's telephone number when it is received by, for example, adding an Outside (CO) Line Access number or adding/deleting certain digits of incoming telephone numbers automatically. This allows an extension user to make a call later to a telephone number logged in his or her call log without worrying about Outside (CO) Line Access numbers, area codes, etc.

Notes

- The term "Caller ID" used in this Feature Guide refers to features that can receive caller information sent from the telephone company and received on outside (CO) lines. Your network provider may use a different name for this type of service.
- To receive Caller ID information, you must subscribe to the telephone company's Caller ID service and enable Caller ID for the appropriate outside (CO) lines through system programming (→ Caller ID [900]).
- Caller ID signalling type, FSK (Frequency Shift Keying) (Bell 202 or V.23) or DTMF (Dual Tone Multi-Frequency), can be selected to match the type used by your telephone company through system programming (→ Caller ID Type [910]).

Caller ID Display on SLT

This feature is available only for SLTs compatible with either FSK-type Caller ID or DTMF-type Caller ID.

Notes

- This feature complies with ETSI (European Telecommunications Standards Institute)-type FSK and Bellcore-type FSK.
- This feature does not comply with methods using DT-AS signal or line reversal signal.

1. Caller ID-Related Feature

Feature	Description	Details in
Incoming Call Log	Caller ID information is automatically recorded in the call log of the extension that received the call. This information can be used to view a record of incoming calls or make calls to any number in the call log.	• 1.16.2 Incoming Call Log

2. Caller ID Automatic 0 Addition

When a call containing Caller ID information is received, the PBX can add "0"¹ to the caller's telephone number as a leading number if it does not begin with "0", through system programming (→ Caller ID Automatic 0 Addition [905]).

¹ For New Zealand, "0" can be added to the received telephone number when the maximum length of a telephone number is 8, 9 or 10 digits, and "00" can be added to the received telephone number when the maximum length is 11 digits or more.

3. Automatic Caller ID Number Modification

When Caller ID information is checked, the PBX can automatically modify the caller's telephone number according to a preprogrammed set of rules (Caller ID Modification Table). This modified number allows the extension user to make a call to this number later without worrying about Outside (CO) Line Access numbers, area codes, etc.

[Programming Example: Caller ID Modification Table]

Call Type	Code No.	Area Code*1	Removed No. of Digits	Added No.
Local Call*2	1	212	3	Not Stored
	2	011	3	001
	(Cont.) :	:	:	:
	:	:	:	:
	5			
Long-distance Call*3	[Not programmable]		0	1

*1 → Caller ID Area Code [901]

*2 → Caller ID Modification for Local Calls [902]

*3 → Caller ID Modification for Long-distance Calls [903]

<Modification Flowchart>

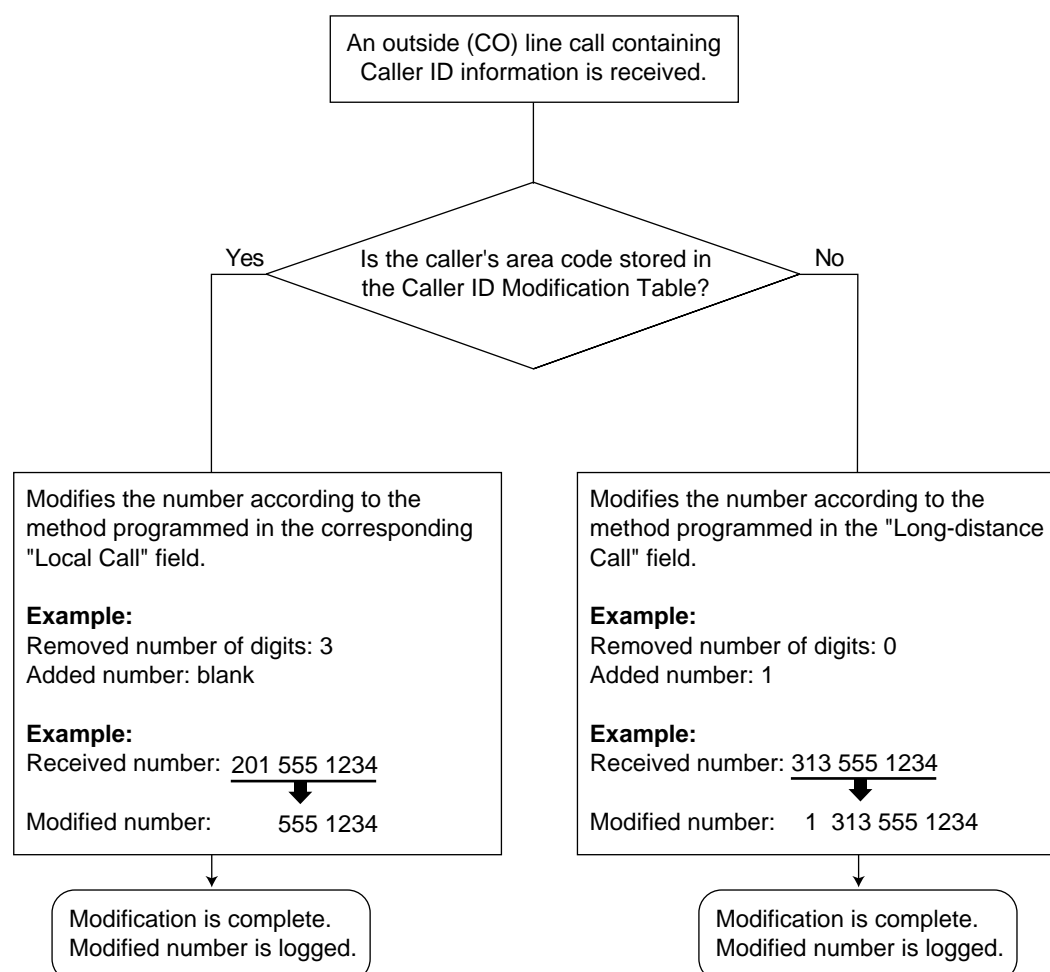
**4. Displaying the Caller's Name**

When a call containing Caller ID information is received, the PBX will search for the caller's name in the following order, then show that name on the display.

- 1) The System Speed Dialling Table
- 2) The Caller ID information received from the telephone company

If a caller's name is not stored in the PBX or sent from the telephone company, it will not be displayed.

Conditions**[General]**

- **Hardware Requirement:** An optional Caller ID card.

[Caller ID Display on SLT]

- **Caller ID Display on SLT feature applies to:**
Intercom calls and outside (CO) line calls.
Intercom calls include forwarded calls, calls from Transfer Recall and Hold Recall.
Outside (CO) line calls include calls directed to Uniform Call Distribution (UCD) or Direct Inward System

1.16 Caller ID Features

Access (DISA) ring groups, forwarded calls, intercepted calls, or calls from extensions that placed outside (CO) line calls on consultation hold.

- SLT Caller ID signalling type can be selected through system programming (→ SLT Caller ID Signalling Type [150]).
- Each SLT (including an SLT connected in parallel with a PT) can be programmed to receive Caller ID information through system programming (→ SLT Caller ID [628]).
- When the caller's telephone number is sent to an SLT, an Outside (CO) Line Access number can be automatically added to the telephone number through system programming (→ SLT Caller ID Line Access Number [151]), to be used when calling the caller back.
- If a call is transferred, forwarded, or intercepted via Intercept Routing to an SLT, the original caller's information will be shown on the SLT.
- During a conversation, Caller ID information will not be shown on the SLT.
- When FSK-type Caller ID information is received, the caller's telephone number (max. 20 digits), name (max. 16 characters), date and time, or the reason for nondisplay of Caller ID information such as "Private", "Out of Area", or "Long Distance" will be shown on the SLT. If the caller's telephone number exceeds 20 digits, the SLT receives only the first 20 digits. If the caller's name exceeds 16 characters, the SLT receives only the first 16 characters.
- When DTMF-type Caller ID information is received, the caller's telephone number (max. 16 digits) or the reason for nondisplay of Caller ID information will be shown on the SLT. If the caller's telephone number exceeds 16 digits, the SLT receives only the first 16 digits. However, when a value less than "1500 ms" is set through system programming (→ SLT Ring Bell-on Time [143]), the SLT receives only the first 10 digits.
- Depending on the type of SLT being used, caller names and the dates and times that calls were received may not be able to be shown on the SLT.
- If an outside caller disconnects a call to an SLT on which the call's Caller ID information is displayed, and the SLT receives another outside (CO) line call directly after, the SLT will wait until a preprogrammed time has passed (→ SLT Ring Wait Time for New Call [627]) before it starts to ring, and the new caller's Caller ID information will be shown on the SLT. A certain amount of time may be required between calls for an SLT to receive Caller ID information correctly.
- To enable the Caller ID feature, it may be necessary to set the same ring tone pattern (→ SLT Fixed Bell Pattern [629]) as used by the telephone company.
- When an SLT is programmed to receive Caller ID information, the ringing of calls with Caller ID on that SLT is delayed for a few seconds. Therefore, the length of time before calls are forwarded or intercepted, and the length of time that intercepted calls ring at the destination SLT, may be slightly shorter than the duration specified through system programming.

Installation Manual References

2.3.5 3-Port Caller ID Card (KX-TE82494)

Feature Guide References

1.6.1.5 Speed Dialling—Personal/System

1.20.1 Station Message Detail Recording Feature

4.2.1 Tones/Ring Tones

1.16.2 Incoming Call Log

Description

When a call containing Caller ID information is received by an extension, the information is shown on the telephone display, notifying the extension user of the caller's identity.

This information is also automatically logged in the Incoming Call Log of the extension, and can be viewed later or used to call that caller back.

There are 2 types of call log areas available in the PBX. One is the personal area, which stores logs of calls received by each extension when a call arrives at a certain proprietary telephone (PT).

The other is the common area, which stores a log of calls arriving at multiple PTs or via the Direct Inward System Access (DISA) Intercept Routing feature. Caller ID information can be logged by the following methods:

- Logged automatically when no one answers calls.
- Logged automatically if an extension user presets logging of the caller's information when answering calls.
- Logged manually by pressing the Caller ID Indication button during a conversation.
- Logged automatically when a caller leaves a voice message (→ 1.15.7 Built-in Voice Message (BV))

[Example]

If the information is stored in record "002",

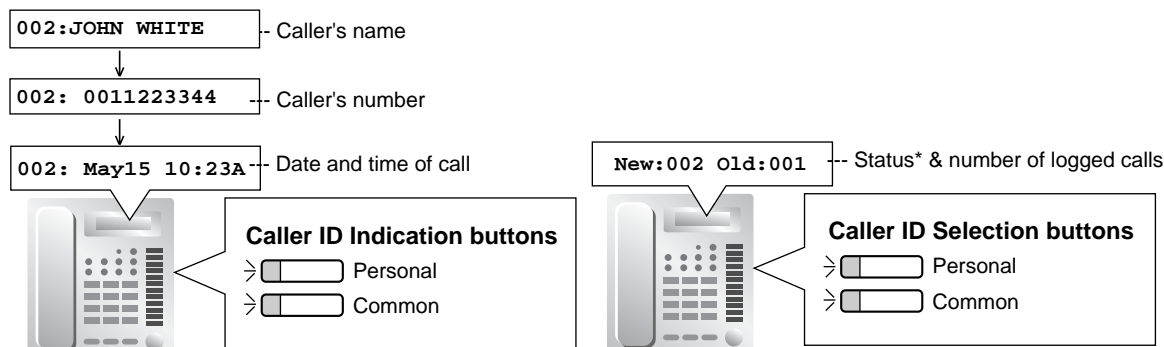

* "New" is displayed for call records that have not previously been viewed;
 "Old" is displayed for call records that have previously been viewed.
 Both new and old call records are stored in each personal and common area.

Conditions

• Caller ID Indication—Personal/Common Button

A flexible CO button can be customised as a Caller ID Indication—Personal/Common button, and will indicate the status of the Incoming Call Log for the extension, as shown below.

Light pattern	Status of the corresponding call log
Red on	There are new call records since the last time the call log was viewed.
Off	There are no new call records in the call log, or the call log has been already viewed.

The Caller ID Indication—Personal/Common button will alert an extension user to any missed (unanswered) calls.

The Caller ID Indication—Personal/Common button is also used to store the information of an incoming call during a conversation, and to view caller information while on-hook and then call back a caller. If a Caller ID Indication—Common button is not assigned to any PT, the calls will be logged in the personal area of the PT that is connected to the lowest-numbered jack, and its Caller ID Indication—Personal button light will turn red.

- **Caller ID Selection—Personal/Common Button**

A flexible CO button can be customised as a Caller ID Selection—Personal/Common button. The Caller ID Selection—Personal/Common button is used to display the number of logged calls while on-hook, to display and cycle through the information of an incoming call during a conversation, while receiving a call, or while viewing caller information, and to inform an extension user that the personal or common area call log is full. The user may also change the displayed information by pressing the "#" key instead of the Caller ID Selection—Personal/Common button while receiving a call, or while viewing caller information.

- It is programmable whether the user can view call logs stored in the common area or not (→ Common Area Call Log Check [909]). If this programme is enabled, the Caller ID Indication—Common button and Caller ID Selection—Common button can be assigned.

- **Incoming Call Log Memory**

The total number of incoming calls that can be logged by the PBX is limited (→ 4.1.1 Capacity of System Resources). When a call log is full (personal area: 20 calls, common area: 300 calls), the Caller ID Selection—Personal/Common button light will turn red. When a caller leaves a voice message, it is automatically linked to the Caller ID information in the Incoming Call Log. Up to 125 voice messages per BV resource are stored separately from the Incoming Call Logs mentioned above.

It is possible for an extension user (or the operator/manager) to select whether the oldest call in the personal area (or common area) will be replaced each time a call is received, or whether the new call information will be discarded, by entering the 21st Incoming Call Logged in the Personal Area (or 301st Incoming Call Logged in the Common Area) feature number.

Caller records for all call logs of an extension are numbered sequentially as they are received, regardless of which call log the information is stored in. For example, information on the first call received will be stored as record "001" (e.g., 001, logged in the personal area) and information on the second call received will be stored as record "002" (e.g., 002, logged in the common area), whether it is logged in the personal area, common area, or BV.

If the call log in the personal area becomes full when the 21st call (e.g., 110, logged in the personal area) has been set to overwrite the oldest call (001, logged in the personal area),

- The oldest call will be deleted and subsequent records will be moved one number down, if the 21st call is unanswered or if it is answered but has different information from the 20th call.
- The 21st call will be discarded and the previous call information will stay as it is, if the 21st call is answered and has the same information as the 20th call.

Common area call logs function in the same way.

- If a transferred call (unscreened) is not answered, the information is logged in the personal area of the final destination.
- Regardless of the telephone type being used, the recorded voice message is associated with the caller's information.
- Even if no flexible CO button is assigned as a Caller ID Indication—Personal button or a Caller ID Indication—Common button, a caller can leave a voice message in that personal/common message area and the Caller ID information, including associated voice messages will be logged.
- **Incoming Call Log Display Lock**

An extension user can lock the Incoming Call Log (including associated voice messages) stored in his or her personal area, preventing other users from viewing its contents (→ 1.8.4 Extension Lock). The operator or manager can cancel the lock in the case that the extension user forgets the lock code

(Extension Lock—CANCEL ALL).

The Incoming Call Log for the common area can only be locked or unlocked by the operator or manager.

- **Automatic Caller ID Number Modification**
If the PBX is programmed to automatically modify incoming telephone numbers, the modified numbers will be displayed when Caller ID information is checked. Extension users can also modify the incoming telephone numbers manually.
- **Initial Display Selection**
If the Caller ID service provides both the number and name, the user can select which is shown first on the display of the PT through system programming (→ Caller ID Log Priority [904]).
- While a user is viewing his or her extension's Incoming Call Log, if the caller whose information is being viewed also left a voice message, the Message/Ringer Lamp or the MESSAGE button light will turn on. The associated voice messages in that personal/common message area can be played or erased with the MESSAGE button or the TRANSFER button respectively.
- Even if there are message waiting indications left at a user's extension, the Message/Ringer Lamp or the MESSAGE button light that displays notifications from the Message Waiting feature (→ 1.17.1 Message Waiting) turns off while the user is viewing his or her extension's Incoming Call Log with the Caller ID Indication—Personal/Common button.
- If a user erases voice messages by any method (for example, by using BV or performing System Data Clear), the caller's information is erased from the extension's Incoming Call Log simultaneously.
- Even if a caller does not leave a voice message, for example, by going on-hook while hearing a personal/common BV outgoing message (OGM), the information is logged in the corresponding Incoming Call Log (common or personal area).
- During a conversation with an extension or outside party, an extension user can transfer the call to another extension that has set incoming calls to be forwarded to that extension's personal message area, or can transfer the call to the personal message area using the Direct Message feature of BV. If the transferring user performs Call Transfer with Announcement, there is a chance that both parties may be recorded in the same message. In this case, the information of the last extension or outside party that recorded the message is logged in the corresponding Incoming Call Log (personal area).

Feature Guide References

1.16.1 Caller ID

1.18.2 Flexible Buttons

User Manual References

1.9.1 Calling with the Incoming Call Log

2.1.4 Erasing All Caller Information in the Common Area (Incoming Call Log in the Common Area—CLEAR ALL)

2.1.5 Disregarding the Newest Call or Overwriting the Oldest Call in the Common Area Call Log (301st Incoming Call Logged in the Common Area)

1.17 Message Features

1.17.1 Message Waiting

Description

When an extension user calls another extension user who does not answer the call, he or she can leave a message waiting indication. The appropriate button or lamp on the called extension user's telephone will light, indicating that a call was missed, or a message recorded by the Voice Processing System (VPS) or Built-in Voice Message (BV) feature is waiting. A MESSAGE button can be used to call the caller back or listen to the message.

When a message is left for a proprietary telephone (PT), the MESSAGE button on it lights, or the Message/Ringer Lamp turns red. Pressing the lit MESSAGE button while on-hook shows the caller's information as shown below:

[Example]

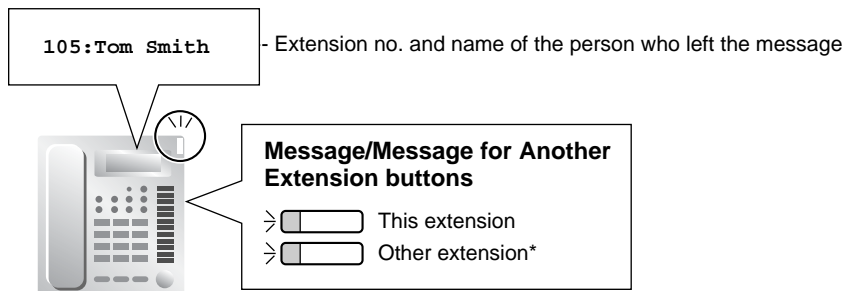

* This button is useful when, for example, the manager checks messages left for another extension.

Conditions

- System programming determines the single line telephones (SLTs) that can receive the message waiting notifications left by another extension (→ SLT Message Waiting [619]).
- If a user goes off-hook with an SLT that has messages waiting, a special dial tone (dial tone 3) will be heard. The user can call a caller back or listen to the message by entering the Message Waiting Answer feature number.
- **Message for Another Extension Button**
A flexible CO/Direct Station Selection (DSS) button can be customised as a Message for Another Extension button. This button can be used on a PT that is allowed through system programming (→ Message Waiting for Another Extension [618]) to access messages (except Built-in Voice Message [BV] messages) left for another extension or voice messages stored in another extension's VPS mailbox.
- **Message Waiting for Another Extension Lock**
An extension user can lock or unlock message waiting indications to prevent others from viewing, calling back or clearing message waiting indications left at his or her extension. The operator or manager can override this lock to unlock it (Extension Lock—CANCEL ALL).
Even while this lock is on, the user can view, call back, or clear message waiting indications left at his or her own extension.
- Both the calling extension and the called extension can cancel a notification after it has been left.

- Message waiting indications are always left on the originally called extension. Message waiting indications cannot be sent to an FWD destination (→ 1.3.1.2 Call Forwarding (FWD)) or an idle extension hunting destination (→ 1.2.1 Idle Extension Hunting).
- A message waiting indication is automatically cleared when the called extension calls the caller back and the call is answered.
- **Message Waiting Indication via Voice Mail APT Integration**
If a voice message is left for the called extension, it can be heard by following the Voice Mail prompts after pressing the lit MESSAGE button (→ 1.19.1 Voice Mail APT Integration).
- **Message Waiting Indication via BV**
If a voice message is left in the user's personal message area or the common message area, it can be played back with the lit MESSAGE button by the user or the operator/manager respectively (→ 1.15.7 Built-in Voice Message (BV)).
- It is possible to activate the Message/Ringer Lamp (→ KX-T7700 Series Incoming Lamp Control [968]) on the KX-T7700 series telephones for the following incoming calls:
 - Incoming call from another extension to a busy extension when the called extension has set Call Waiting (Call Waiting Tone 1)
 - Incoming doorphone call whose ring tone pattern is set to "S-Double" (→ Doorphone Ring Tone Pattern [706]) (except when using the Paralleled Telephone feature) when an optional doorphone or doorbell/door chime is connected to the PBX

Feature Guide References

- 1.18.1 Fixed Buttons
- 1.18.2 Flexible Buttons

User Manual References

- 1.2.4 When the Dialed Party is Busy or There is No Answer
- 1.5.5 Using Voice Messaging (Built-in Voice Message [BV])
- 1.8.3 If a Voice Processing System is Connected

1.17.2 Absent Message

Description

Extension users can prepare a brief text message (Absent Message) that will be displayed to other extension users when they are called. This message can explain the reason for their absence, and can be used by any extension user.

The following Absent Messages may be programmed:

Message No.	Message
1	Will Return Soon
2	Gone Home
3	At Ext %%% (Extension Number)
4	Back at %:% (Hour:Minute) AM (or PM)
5	Out Until %/% (Month/Day)*
6	In a Meeting

Notes

- * The date order varies depending on the user's country/area.
- The "%" shown above indicates a parameter to be entered when assigning a message at an individual extension.

Conditions

- An extension user can select only one Absent Message at a time. The selected message is displayed at the extension every time the user goes off-hook.
- The caller must be using a display proprietary telephone (PT) to see the Absent Message.

User Manual References

1.5.2 Showing a Message on the Caller's Telephone Display (Absent Message)

1.17.3 Fixed Line SMS Terminal Support

Description

When outside (CO) line calls are received from a Short Message Service (SMS) centre, the PBX can route incoming calls to specific single line telephones (SLTs) that support SMS according to a preprogrammed set of rules (SMS Routing Table). Fixed Line SMS is a service that allows text messages to be sent and received via Public Switched Telephone Network (PSTN) access.

If a user subscribes to his or her telephone company's Caller ID service and the PBX receives an SMS centre call from the registered SMS centre number, the PBX will relay the text message to the SLT. In all other cases, incoming outside (CO) line calls will be directed according to system programming (→ CO Line Mode—Day/Night/Lunch [414-416]).

To make or receive SMS centre calls using fixed lines, the PBX and specific SLTs must be programmed so they will know how to handle those calls. To programme SLTs, refer to the Operating Instructions supplied with the SLTs.

Notes

- This feature complies with the following ETSI (European Telecommunications Standards Institute) specifications:
ETSI ES 201 912
- This feature is available only for SLTs that support SMS. SMS service depends on the contract with your telephone company.

[Programming Example: SMS Routing Table with Sub-address Numbers]

When the SMS centre number used to receive SMS centre calls is "1112224444" and the telephone numbers of each outside (CO) line are "3847001" for CO 1/2 and "3847002" for CO 3, programme as follows:

1) PBX setting

SMS Centre Number for Receiving*1: 1112224444

Location No.	Outside (CO) Line No.*2	Extension Jack No.*3
1	CO 1, CO 2	Jack 01, Jack 02, Jack 03
2	CO 3	Jack 10, Jack 11
(Cont.) :	:	:
:	:	:
8	Not Stored	Not Stored

*1 → SMS Centre Number for Receiving [145]

*2 → SMS Routing Table—CO [146]

*3 → SMS Routing Table—Extension [147]

If the SMS centre supports sub-address numbers, up to 8 SLTs can be assigned as the SMS destinations for a single location. One location can be used for each outside (CO) line telephone number.

2) SLT setting

Extension Jack No.	SMS Centre Number for Sending	SMS Centre Number for Receiving	SMS Sub-address
Jack 01	89*1 P*21112223333	1112224444	1
Jack 02	89*1 P*21112223333	1112224444	2
Jack 10	89*1 P*21112223333	1112224444	1
(Cont.) :	:	:	:
:	:	:	:

*1 89: Outside (CO) Line Access number used to make SMS centre calls using the fixed outside (CO) lines.

When the SMS centre can receive an SMS message from any telephone number, the Automatic Line Access number or Outside (CO) Line Access number can also be used respectively.

*2 P: Pause

In this example:

- a) To send an SMS message to the SLT connected to extension jack 01, enter "38470011" as the destination.
- b) To send an SMS message to the SLT connected to extension jack 02, enter "38470012" as the destination.
- c) To send an SMS message to the SLT connected to extension jack 10, enter "38470021" as the destination.

[Programming Example: SMS Routing Table without Sub-address Numbers]

When the SMS centre number used to receive SMS centre calls is "1112224444" and the telephone numbers of each outside (CO) line are "3847001" for CO 1, "3847002" for CO 2, and "3847003" for CO 8, programme as follows:

1) PBX setting

SMS Centre Number for Receiving: 1112224444

Location No.	Outside (CO) Line No.	Extension Jack No.
1	CO 1	Jack 01
2	CO 2	Jack 02
(Cont.) :	:	:
:	:	:
8	CO 8	Jack 08

If the SMS centre does not support sub-address numbers, only one SLT can be assigned for each location.

One location can be used for each outside (CO) line telephone number.

2) SLT setting

Extension Jack No.	SMS Centre Number for Sending	SMS Centre Number for Receiving	SMS Sub-address
Jack 01	89 P1112223333	1112224444	–
Jack 02	89 P1112223333	1112224444	–
Jack 08	89 P1112223333	1112224444	–
(Cont.) :	:	:	:
:	:	:	:

In this example:

- a) To send an SMS message to the SLT connected to extension jack 01, enter "3847001" as the destination.
- b) To send an SMS message to the SLT connected to extension jack 02, enter "3847002" as the destination.
- c) To send an SMS message to the SLT connected to extension jack 08, enter "3847003" as the destination.

Conditions

- **Hardware Requirement:** An optional Caller ID card.
- The PBX relays text messages from the SMS centre to SMS-enabled SLTs, and vice versa.
- To receive SMS information, you must subscribe to the telephone company's Caller ID service and enable Caller ID for the appropriate outside (CO) lines through system programming (→ Caller ID [900]).
- Each SMS-enabled SLT must be programmed to receive Caller ID information through system programming (→ SLT Caller ID [628]).
- If an SLT user sets the Automatic Callback Busy feature by dialling "6" because the selected line is busy when he or she tries to send a text message, the SLT will ring when the line becomes idle. To send the text message, the user must answer the callback ring, go on-hook, and then make an SMS centre call again.
- When a call is received on one of the outside (CO) lines preprogrammed in an SMS Routing Table, the destination SLT may ring one time.
- If a user wants to receive SMS messages on an SLT, it is recommended to not connect a proprietary telephone (PT) in parallel. If the PT user answers the call, the SMS message will not be received.
- When an SMS centre call is received at an SLT that has set the Call Forwarding (FWD) feature, the FWD feature will not function and the SMS message is received by that SLT.
- When an SLT user makes an SMS centre call, in some cases the duration of the call may not be verified with SMDR (→ 1.20.1 Station Message Detail Recording Feature), because it takes very little time to send SMS messages. To verify the duration of these calls, it is recommended to set the start timer of call duration to "5 s" or "Instantly" through system programming (→ Call Duration Counter Start [204]).
- When a user on an SLT that is in "TONE (DTMF)" mode makes an SMS call using outside (CO) lines set to "Pulse" or "Call Block" mode through system programming (→ Dial Mode [401]), if the SMS centre number is longer than supported, for example 16 digits, the SMS call may not be completed. In this case, set the dialling mode of the SLT to "PULSE" mode using the switch.

Installation Manual References

2.3.5 3-Port Caller ID Card (KX-TE82494)

1.18 Proprietary Telephone (PT) Features

1.18.1 Fixed Buttons

Description

Proprietary telephones (PTs) and Direct Station Selection (DSS) Consoles feature a wide variety of feature buttons and Line Access buttons, explained below.

Note that certain models do not have certain buttons.

For a description of the buttons found on each PT or DSS Console, please refer to the Operating Instructions for each PT or DSS Console.

[PT]

Button	Function
Navigator Key	Used to adjust the volume of the speaker, handset and headset, and the display contrast, or to select desired items.
Volume Key	Used to adjust the volume of the speaker, handset and headset.
PROGRAM	Used to enter and exit programming mode.
FLASH/RECALL	Used to disconnect the current call and make another call without hanging up (Flash/Recall mode), or to send an EFA (External Feature Access) signal to the telephone company or host PBX to access external features (EFA mode).
HOLD	Used to place a call on hold.
SP-PHONE (Speakerphone)	Used to select handset or hands-free operation.
MONITOR	Used to select hands-free dialling and monitor operation.
MESSAGE	Used to leave a message waiting indication, call back the party who left a message waiting indication, or play back voice messages. This button is provided with an LED (Light Emitting Diode), except for on KX-T7700 series telephones. With KX-T7700 series telephones, the Message/Ringer Lamp is lit when a message waiting indication is left at an extension.
REDIAL	Used to redial the last number dialled.
TRANSFER	Used to transfer a call to another party.
Flexible CO	Used to access an outside (CO) line (or outside (CO) line group) when making or receiving a call. The button's preprogrammed Outside (CO) Line Access method determines which line is selected (Default: Single-CO [S-CO]). Can also be customised as a feature button.
INTERCOM	Used to make or receive intercom calls.
AUTO ANS (Auto Answer)/MUTE	Used to answer an intercom call automatically in hands-free mode, or to mute the built-in microphone during a conversation.
VOICE CALL	Used to answer an intercom call automatically.

1.18 Proprietary Telephone (PT) Features

Button	Function
AUTO DIAL/STORE	Used for System Speed Dialling/Saved Number Redial, playing back personal/common BV outgoing messages (OGMs) used by the Built-in Voice Message (BV) feature, and storing programme changes.
CONF (Conference)	Used to establish a 3-party or 5-party conference call.
FWD/DND (Call Forwarding/Do Not Disturb)	Used to set the FWD or DND feature for the extension.
PAUSE	Used to insert a dialling pause in a stored number.
PF (Programmable Feature)	Used to access a preprogrammed feature (no default). Mostly used as a One-touch Dialling button.

[DSS Console]

Button	Usage
Flexible DSS	Used to call an extension with a one-touch operation. Each button is programmed to correspond to an extension. DSS buttons can also be customised as different feature buttons.
PF	Used to access a preprogrammed feature (no default). Mostly used as a One-touch Dialling button.

Conditions

- Certain buttons are equipped with a light to indicate the status of the corresponding line or feature.

User Manual References

1.1.1 Before Operating a Telephone

1.18.2 Flexible Buttons

Description

Flexible buttons are buttons whose functions can be customised through either system or personal programming. The following types of flexible buttons are found on proprietary telephones (PTs) and/or Direct Station Selection (DSS) Consoles:

- a) Flexible CO buttons
- b) Flexible DSS buttons
- c) Programmable Feature (PF) buttons
- d) Flexible MESSAGE button

[Button Usage]

Button	Function
Single-CO (S-CO)	Used to access a specified outside (CO) line for making or receiving calls (→ 1.5.3.3 Outside (CO) Line Access).
Group-CO (G-CO)	Used to access an idle outside (CO) line in a specified outside (CO) line group for making calls. Incoming calls from outside (CO) lines in the assigned outside (CO) line group arrive at this button (→ 1.5.3.3 Outside (CO) Line Access).
Other-CO (O-CO)	Used to access an idle outside (CO) line for making calls. Incoming calls from the assigned outside (CO) lines, which are not assigned to S-CO or G-CO buttons, arrive at this button (→ 1.5.3.3 Outside (CO) Line Access).
Direct Station Selection (DSS)	Used to call an extension with a one-touch operation (→ 1.5.1.1 Intercom Call).
One-touch Dialling	Used to call a preprogrammed party or access a feature with a one-touch operation (→ 1.6.1.2 One-touch Dialling).
Message	Used to leave a message waiting indication, call back the party who left the message waiting indication, or play back voice messages (→ 1.17.1 Message Waiting).
Message for Another Extension	Used to access messages (except Built-in Voice Message [BV] messages) left for another extension or voice messages stored in another extension's Voice Processing System (VPS) mailbox (→ 1.17.1 Message Waiting).
FWD/DND (Call Forwarding/Do Not Disturb)	Used to set the FWD or DND feature for the extension (→ 1.3.1.1 Call Forwarding (FWD)/Do Not Disturb (DND)—OVERVIEW).
Save	Used to store a telephone number while in a conversation with an outside party or while hearing a busy tone, and then easily redial the number later (→ 1.6.1.4 Redial).
Conference	Used to establish a 3-party or 5-party conference call (→ 1.13.1.2 Conference).
Caller ID Indication—Personal	Used to inform an extension user of calls logged in his or her personal area, store the information of an incoming call during a conversation, and view caller information while on-hook and then call back a caller (→ 1.16.2 Incoming Call Log).

1.18 Proprietary Telephone (PT) Features

Button	Function
Caller ID Selection—Personal	Used to display and cycle through the information of an incoming call during a conversation, while receiving a call, or while viewing caller information, display the number of logged calls while on-hook, and inform an extension user that the personal area call log is full (→ 1.16.2 Incoming Call Log).
Caller ID Indication—Common	Used to inform an extension user of calls logged in the common area, store the information of an incoming call during a conversation, and view caller information while on-hook and then call back a caller (→ 1.16.2 Incoming Call Log).
Caller ID Selection—Common	Used to display and cycle through the information of an incoming call during a conversation, while receiving a call, or while viewing caller information, display the number of logged calls while on-hook, and inform an extension user that the common area call log is full (→ 1.16.2 Incoming Call Log).
Log-in/Log-out	Used to switch between Log-in and Log-out status (→ 1.2.4 Log-in/Log-out).
Day	Used to change the time service mode to day mode (→ 2.2.3 Time Service).
Night	Used to change the time service mode to night mode (→ 2.2.3 Time Service).
Lunch	Used to change the time service mode to lunch mode (→ 2.2.3 Time Service).
Extension Lock	Used to remotely lock or unlock another extension (→ 1.8.4 Extension Lock).
2-way Record	Used to record a conversation into the user's own mailbox (→ 1.19.1 Voice Mail APT Integration).
2-way Transfer	Used to record a conversation into the mailbox of a specified extension (→ 1.19.1 Voice Mail APT Integration).
Live Call Screening (LCS)	Used to listen while a caller is leaving a message in the user's voice mailbox and, if desired, intercept the call (→ 1.19.1 Voice Mail APT Integration).
LCS Cancel	Used to stop monitoring the user's own voice mailbox while a caller is leaving a message, or stop the alert tone heard in private mode while a caller is leaving a message (→ 1.19.1 Voice Mail APT Integration).
Voice Mail (VM) Transfer	Used to transfer a call to the mailbox of a specified extension (→ 1.19.1 Voice Mail APT Integration).

Conditions

- **Extension button confirmation**
A display PT user can confirm the button settings, such as the flexible CO button, by pressing the corresponding button while on-hook.
- The Day, Night, Lunch, and Extension Lock buttons can only be assigned to flexible DSS buttons at an extension assigned as the operator or manager.

User Manual References

3.1.3 Customising the Buttons

1.18.3 LED Indication

Description

The LED (Light Emitting Diode) of the Message/Ringer Lamp and the following buttons (Line Status Buttons and Corresponding Extension Status Button) can indicate line status with a variety of light patterns.

Line Status Buttons: Single-CO (S-CO), Group-CO (G-CO), Other-CO (O-CO), INTERCOM

Corresponding Extension Status Button: Direct Station Selection (DSS)

1. Light Pattern of the Message/Ringer Lamp

- Incoming call from an outside (CO) line/another extension: Red flashing
- Message(s) present (no incoming call): Red on
- No messages present and no incoming call: Off

2. Light Pattern of the Line Status Buttons

Line Status Button Light Pattern	Outside (CO) Line Status			Intercom Line Status
	S-CO	G-CO	O-CO	INTERCOM
Off	Idle			
Green on	This extension is using the line.			
Slow green flashing	This extension is holding the line.			
Moderate-speed green flashing	This extension is holding the line using Exclusive Call Hold or using the line for an unattended conference.			
Rapid green flashing	–	–	–	Incoming call
Red on	Line(s) in use			–
Slow red flashing	Another extension is holding the line.	–	–	–
Rapid red flashing	Incoming call			–

3. Light Pattern of the Corresponding Extension Status Button

Corresponding Extension Status Button Light Pattern	DSS
Off	Idle
Slow red flashing	Call Forwarding (FWD)*
Moderate-speed red flashing	Do Not Disturb (DND)*
Red on	Busy

* This setting can be changed through system programming (→ DSS Lamp Mode [112]).

4. Flashing Light Patterns

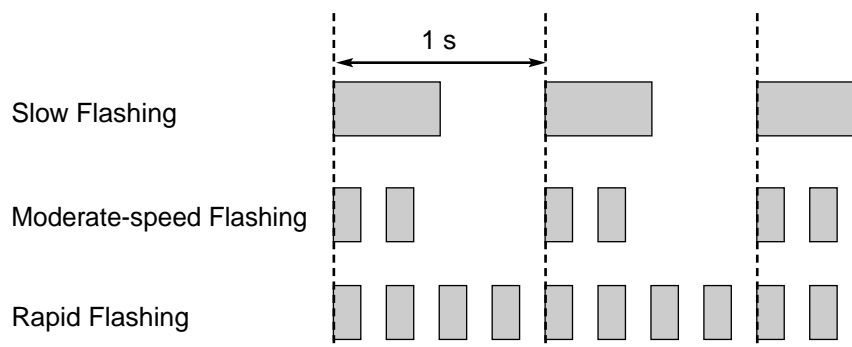

Conditions

- Incoming outside (CO) line calls arrive on available buttons in the following priority:
S-CO → G-CO → O-CO

Feature Guide References

- 1.2.3 Direct Inward System Access (DISA) Ring
- 1.3.1 Call Forwarding (FWD)/Do Not Disturb (DND)
- 1.12.1 Call Hold
- 1.13.1.2 Conference

1.18.4 Display Information

Description

A display proprietary telephone (PT) can relay the following information to the user while making or receiving calls:

Display Item	Display Example	Conditions
The extension number and name of the calling or called extension	123: Tom Smith	Extension numbers and names are programmable (→ Extension Number [009], Extension Name [604]). If an extension name is not stored, only the extension number will be displayed.
The status of the called extension	123: Busy	–
The name and number of the doorphone	DoorPhone 1	–
The telephone number dialled	1234567890	–
The extension number and name of the calling extension after the call is forwarded	→ 102:Mike	–
The received call information a) Caller's name b) Caller's number c) Outside (CO) line number	ABC Company 12345678 Call on CO 1	The first line message can be either (a) or (b) at each extension through system programming (→ Caller ID Log Priority [904]).
The call charge of the current outside (CO) line call	CO1: 12.35 EUR	The charge of a call is displayed when Call Charge Calculation is enabled through system programming (→ Call Charge Calculation [441]). Settings such as the call charge rate, decimal point position and currency can be assigned through system programming (→ 1.20.2 Call Charge Calculation).
The duration of the current outside (CO) line call	CO 1 0:01'15	The display remains for 5 seconds after the call is finished. The outgoing outside (CO) line call duration starts when the specified time expires (→ Call Duration Counter Start [204]). The display does not show the duration of intercom calls.

Conditions

- **Display Contrast**
The display contrast can be adjusted with the Navigator key or the CONTRAST selector. This is available only for PTs.
- **Ringer Volume**
The volume of the ringer can be adjusted with the RINGER Volume selector.
- **Self-extension Number**
A display PT user can confirm his or her own jack number and extension number on the display. Every time the "✳" key is pressed, the display switches between "date (month [day], day [month] and time", "date (month [day], day [month], year, day of the week)", and "extension number (and extension name if stored)".
- **Date and Time Set**
The current date and time are set through system programming (→ Date & Time [000]) or the operator/manager service features. The time format shown on the display PTs while on-hook, "12 h" or "24 h", can also be selected through system programming (→ LCD Time Display [010]).
- Characters (name) or digits (telephone number) exceeding the maximum length of the display are not displayed.
However, even if the information is not displayed properly, the received information is not altered. When the information displayed by pressing specific buttons (One-touch Dialling, REDIAL, Save) while on-hook exceeds 17 characters, the "&" mark will be shown on the right side of the display.
- The call charge, called party's name (when a call is made using System Speed Dialling with a name assigned), and call duration can be displayed alternately by pressing the CO button whose indicator is green. Whether the charge or duration is displayed first can be selected through system programming (→ LCD Display Mode [630]). When Call Charge Calculation [441] is set to "Disable", call charge information is not displayed.
- For each call charge, up to 7 digits excluding the decimal point can be displayed. If the call charge exceeds 7 digits, considering that the decimal point does not move, all numbers will be replaced by nines (e.g., 99999.99).
- The number of decimal digits displayed for the call charge can be programmed through system programming (→ Decimal Places [190]). The charge is rounded up to the preprogrammed number of decimal digits.
- On a conference call, call charge information is not displayed.

User Manual References

2.1.7 Changing System Settings Using Programming Mode

3.1.2 Changing Personal Settings Using Programming Mode

1.19 Voice Mail Features

1.19.1 Voice Mail APT Integration

Description

A Panasonic Voice Processing System (VPS) that supports APT Integration can provide many features and conveniences that are unachievable using traditional voice mail systems that rely on Inband (DTMF) Integration.

Many of these features are explained below. For more information, refer to the Installation Manual supplied with the Panasonic VPS.

1. Automatic Configuration—Quick Setup (or DIP switch initialisation without a PC)

The PBX shares information with the VPS during setup that allows the VPS to automatically create the appropriate mailboxes for all extension numbers.

The following settings to enable APT Integration must be programmed through system programming to match the settings of the VPS.

When 2 VPSs are connected to the PBX, note that each extension can have only one mailbox, but when the VPSs have executed Automatic Configuration, an extension has a mailbox in both VPSs. Therefore, an extension user must delete a mailbox in either VPS so that there are no duplicates.

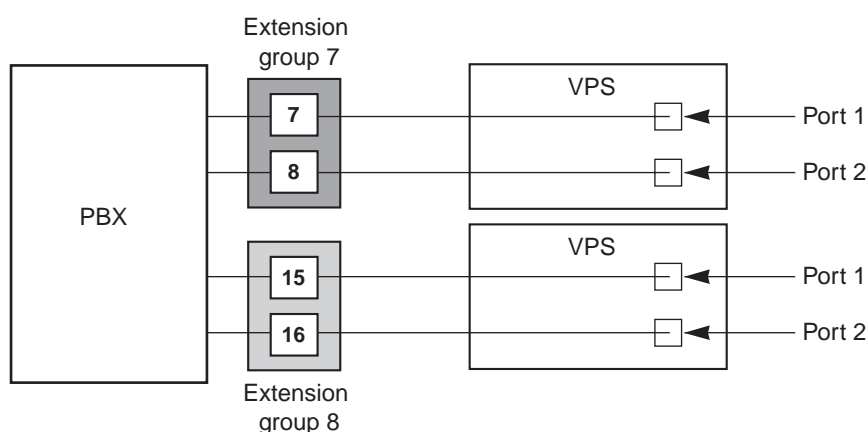

This example uses a Panasonic KX-TVM50/KX-TVP50 VPS, which can be connected with 4-conductor wire to 4 extension jacks of the PBX.

[Programming Example: Voice Mail Table]

APT Integration	VM 1 APT Port*1	VM 2 APT Port*2
Enable	Port 7 & 8	Port 15 & 16

*1 → VM 1 APT Port [130]

*2 → VM 2 APT Port [131]

In this example:

When "Port 7 & 8" is selected for VPS1, extension jacks 07 and 08 are placed in extension group 7 automatically (→ Extension Group [600]). Likewise, when "Port 15 & 16" is selected for VPS2, extension jacks 15 and 16 are placed in extension group 8 automatically. Each extension group can be

1.19 Voice Mail Features

connected to only one VPS. Also the idle extension hunting type is set as "Circular" (→ Hunting Type [101]), and the Voice Mail (VM) Hunting Chain and Automated Attendant (AA) Hunting Chain are automatically enabled in each of these 2 extension groups (→ Hunting Group Set [100]).

Note

When "Disable" is selected, the other settings above are reset to their default values.

2. AA Service

Allows the VPS to answer calls and direct callers to dial a number in order to connect themselves to the desired party (e.g., "Enter the extension number of the desired party.").

It is possible to access VM service from AA service to, for example, record messages.

3. VM Service

Allows callers to leave voice messages for specific parties, such as an extension user. Extension users can then listen to the messages left in their mailboxes at their convenience.

AA Service

A VPS can be used for the AA service as well as the VM service. When a call is directed to a port of the VPS that is in AA service mode, the caller will hear an outgoing message (OGM). After or while listening to the OGM, the caller may dial an extension number as directed (e.g., "Enter the extension number of the desired party.").

1. AA to Extension

AA receives and answers outside (CO) line calls and offers services such as transferring to an extension or mailbox using DTMF signalling from the calling party.

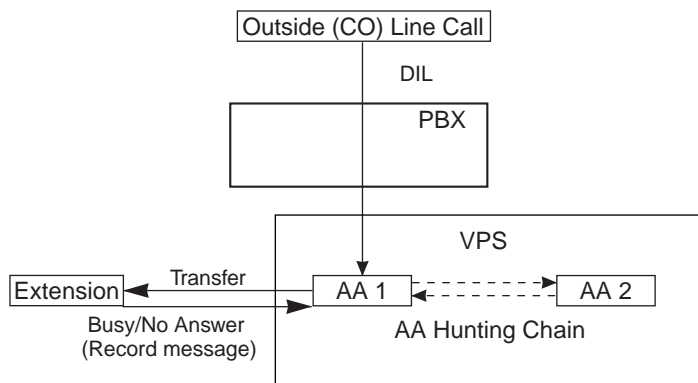

2. Extension Backup

If the VPS is assigned to ring with other extensions, for example the operator, for the same outside (CO) line, the VPS can be used as a backup for the operator when the operator cannot answer an incoming outside (CO) line call.

In order to use this feature, Delayed Ringing must be set for the VPS (→ Delayed Ringing—Day/Night/Lunch [411-413]).

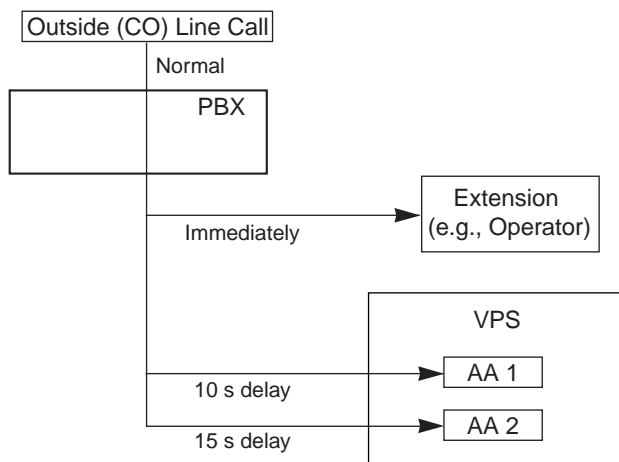

3. Status Notification to the VPS

When a call is redirected to the VPS, the PBX sends the status of the called extension to the VPS. This allows the VPS to appropriately handle the call, playing the appropriate OGM for the caller. For example, if the called extension is in Do Not Disturb (DND) mode, the OGM (e.g., "I am unable to answer your call right now, but I will get back to you shortly.") can be played.

VM Service

1. Accessing a Mailbox

The PBX sends special messages to the VPS to indicate which mailbox should be accessed (**Follow-on ID**).

2. FWD to a Mailbox of the VPS

An extension user can set his or her calls to be forwarded to the VPS (→ 1.3.1.2 Call Forwarding (FWD)). When a call is received at the extension, the PBX sends the extension's mailbox number to the VPS, and the VPS answers the call with the appropriate OGM (e.g., "Hi, I'm out of the office today...").

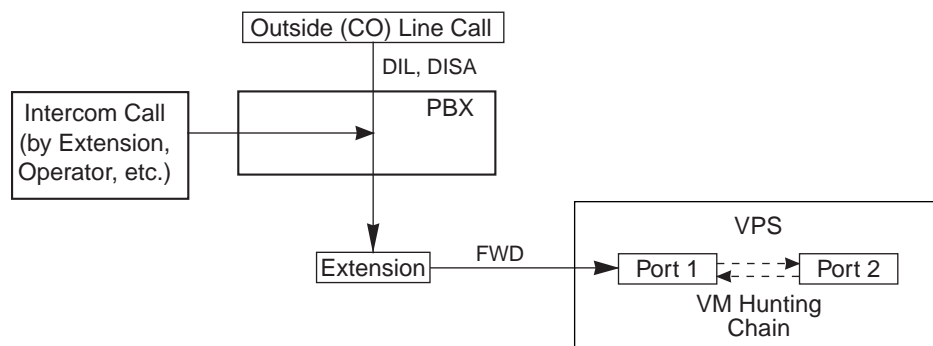

3. Intercept Routing to a Mailbox of the VPS

Outside (CO) line calls via DISA (→ 1.15.6 Direct Inward System Access (DISA)) can be programmed to be automatically redirected to an extension user's mailbox when the extension user does not or cannot answer them (→ 1.1.1.2 Intercept Routing). The VPS can answer the call with an OGM (e.g., "I can't take your call now...") and callers can leave messages in the mailbox. In order to use this feature, a voice mail extension number must be assigned as the intercept destination for the original destination extension that received the call (→ CO Line Mode—Day/Night/Lunch [414-416], Flexible Ringing—Day/Night/Lunch [408-410], Delayed Ringing—Day/Night/Lunch [411-413]), and "Intercept" must be selected through system programming (→ DISA Intercept Mode [507]).

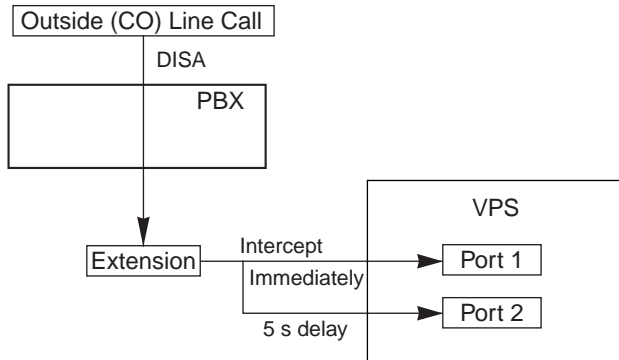

4. Transferring to a Mailbox of the VPS

Extension users can transfer calls to a mailbox, after which callers can leave a message for the desired party. While answering a call, the extension user simply presses the VM Transfer button and enters the extension number of the party the caller wishes to leave a message for. The VPS will answer the transferred call and record a message into the appropriate mailbox.

VM Transfer Button

In order to use this feature, the extension user must use a flexible CO/Direct Station Selection (DSS) button customised as a VM Transfer button. A voice mail extension number must be assigned to the button when creating it.

5. Listening to Recorded Messages

After the VPS records a message, it will light the appropriate lamp or button on the extension for which the message was intended, to indicate that there is a new message (→ 1.17.1 Message Waiting). The proprietary telephone (PT) user can play the message back simply by pressing the MESSAGE button used for mailbox access; he or she does not need to enter a mailbox number. A single line telephone (SLT) user hears a special dial tone (dial tone 3) when going off-hook if there are any messages in his or her mailbox, and can play the message back by entering the Message Waiting Answer feature number.

6. Live Call Screening (LCS)

Similar to a conventional home answering machine, LCS allows a PT user to monitor his or her own mailbox as a caller is leaving a message and, if desired, answer the call simply by pressing the LCS button.

PT users can choose one of 2 ways to perform LCS, through personal programming (Live Call Screening [LCS] Mode Set):

Hands-free mode: The user can screen calls automatically through the built-in speaker.

Private mode: The user will hear an alert tone when a message is being recorded in his or her mailbox. To screen calls, the user must press the MONITOR, SP-PHONE, or LCS button.

LCS/LCS Cancel Button

A flexible CO/DSS button can be customised as an LCS or LCS Cancel button.

7. 2-way Recording into the VPS

PT users can record their own telephone conversations. These recordings can be stored in the PT user's own mailbox (**2-way Record**) or in another user's mailbox (**2-way Transfer**), depending on which button the user presses to begin recording.

2-way Record/2-way Transfer Button

A flexible CO/DSS button can be customised as a 2-way Record or 2-way Transfer button.

Note

You should inform the other party that the conversation will be recorded before beginning to record any telephone conversation.

Conditions**[General]**

- A VPS can be assigned as the destination for the following features:
 - FWD—All Calls
 - FWD—Busy/No Answer
 - DISA Intercept Routing—No Answer (IRNA)

For these features, the caller does not need to know the mailbox number of the called extension because the code is automatically transmitted to the VPS. If a DISA call is forwarded to the VPS by the IRNA feature from a DISA ring group, the PBX will send the VPS the mailbox number of the extension within the DISA ring group that is connected to the lowest-numbered jack.

[Live Call Screening (LCS)]

- To prevent the unauthorised screening of calls, a 3-digit password must be entered when activating LCS for an extension. If the user forgets his or her password, it can be cleared by the operator or manager (LCS Password Control).
- If an extension user is screening a call and then goes off-hook to answer it, the VPS will either stop or continue recording the message, according to system programming (→ LCS Recording Mode Set [620]).
- If a call arrives while an extension user is having a conversation with another party and the extension has Call Waiting activated, the user will hear a call waiting tone. The user can put the existing call on hold before accessing LCS.

[2-way Recording into the VPS]

- If all ports of the VPS are busy when a user tries to record a conversation:
 - The user hears an alarm tone when pressing the 2-way Record button.
 - The user hears an alarm tone after pressing the 2-way Transfer button followed by an extension number.

Feature Guide References

1.18.2 Flexible Buttons

User Manual References

1.8.3 If a Voice Processing System is Connected

3.1.2 Changing Personal Settings Using Programming Mode

1.19.2 Voice Mail Inband (DTMF) Integration

Description

A Panasonic Voice Processing System (VPS) or similar product from another manufacturer can provide Automated Attendant (AA) and Voice Mail (VM) services when connected to the PBX.

The VPS and PBX communicate with each other by sending DTMF (Dual Tone Multi-Frequency) signals. For more information, refer to the documentation provided with the VPS.

1. AA Service

Allows the VPS to answer calls and direct callers to dial a number in order to connect themselves to the desired party (e.g., "Enter the extension number of the desired party."). It is possible to access VM service from AA service to, for example, record messages.

2. VM Service

Allows callers to leave voice messages for specific parties, such as an extension user. Extension users can then listen to the messages left in their mailboxes at their convenience.

AA Service

A VPS can be used for the AA service as well as the VM service. When a call is directed to a port of the VPS that is in AA service mode, the caller will hear an outgoing message (OGM). After or while listening to the OGM, the caller may dial an extension number as directed (e.g., "Enter the extension number of the desired party.").

If the VPS transfers a call via the AA service, the PBX will inform the VPS of the status of the called party using a DTMF status signal so that the VPS will know the status. This enables the VPS to quickly play an appropriate OGM to the caller (e.g., "I'm handling another call now...", "I'm away from my desk now...", etc.). The DTMF status signals sent by the PBX are explained below.

[DTMF Status Signals]

Status	Condition	DTMF Status Signal
Ringback Tone	The PBX is ringing the corresponding extension.	1
Busy Tone	The called extension is busy.	2
Reorder Tone	The dialed number is invalid.	3
DND Tone	The called extension has set DND (→ 1.3.1.3 Do Not Disturb (DND)).	4
Answer	The called extension has answered the call.	5
Confirm	The PBX confirms that a feature (such as Message Waiting) has been set or cancelled on the extension.	9
Disconnect	The caller has hung up.	#9
FWD to VM Ringback Tone	The called extension has set FWD to VPS (→ 1.3.1.2 Call Forwarding (FWD)) and the PBX is calling another port of the VPS.	6
FWD to VM Busy Tone	The called extension has set FWD to VPS and all ports of the VPS are busy.	7

1.19 Voice Mail Features

Status	Condition	DTMF Status Signal
FWD to Extension Ringback Tone	The PBX is calling an extension other than the one dialled, most likely because the called extension has set its calls to be forwarded to another extension or because it is a member of an idle extension hunting group (→ 1.2.1 Idle Extension Hunting).	8

System Programming

The following settings to enable Inband (DTMF) Integration must be programmed through system programming to match the settings of the VPS. This example uses a Panasonic KX-TVM/KX-TVP series VPS, which can be connected to up to 4 extension jacks of the PBX.

[Programming Example: Voice Mail Table]

DTMF Integration*1	Voice Mail Port*2				Numbering Plan*3
	Jack 07	Jack 08	Jack 15	Jack 16	
Enable	Enable	Enable	Disable	Disable	Plan 1 or Plan 2

*1 → DTMF Integration [103]

*2 → DTMF Integration Port [102]

*3 → Extension Number [009]

In this example:

To enable the VM Hunting Chain and AA Hunting Chain, programme as follows:

- 1) Assign all Voice Mail extensions to one extension group in Extension Group [600].
- 2) Assign "Enable" to the group in Hunting Group Set [100].
- 3) Select the hunting type of the group in Hunting Type [101].

VM Service

1. Accessing a Mailbox

The PBX sends DTMF signals to the VPS to indicate which mailbox should be accessed (**Follow-on ID**).

2. Listening to Recorded Messages

After the VPS records a message, it will light the appropriate lamp or button on the extension for which the message was intended, to indicate that there is a new message (→ 1.17.1 Message Waiting). The proprietary telephone (PT) user can play the message back simply by pressing the MESSAGE button used for mailbox access. When the button is pressed, the PBX calls the voice mail extension, then sends DTMF signals to the VPS to indicate the extension's mailbox number.

A single line telephone (SLT) user hears a special dial tone (dial tone 3) when going off-hook if there are any messages in his or her mailbox, and can play the message back by entering the Message Waiting Answer feature number.

Conditions

- A VPS can be assigned as the destination for the following features:

- FWD—All Calls
- FWD—Busy/No Answer
- DISA Intercept Routing—No Answer (IRNA) (→ 1.1.1.2 Intercept Routing, 1.15.6 Direct Inward System Access (DISA))

For these features, the caller does not need to know the mailbox number of the called extension because the code is automatically transmitted to the VPS. If a DISA call is transferred to the VPS by IRNA from a DISA ring group, the PBX will transmit the mailbox number of the receiving extension with the lowest jack number.

- In order to achieve proper recording quality, Data Line Security should be turned on for the VPS (→ 1.10.5 Data Line Security).
- Each extension's mailbox number is the same as its extension number.
- If "TA series" cannot be selected with the PBX type setup menu of the KX-TVM/KX-TVP series VPS, select "KX-T1232". Follow the steps for the KX-T1232.

User Manual References

1.8.3 If a Voice Processing System is Connected

1.20 Administrative Information Features

1.20.1 Station Message Detail Recording Feature

1.20.1.1 Station Message Detail Recording (SMDR)

Description

Automatically logs detailed information for the PBX.

1. SMDR Output Port

The Serial Interface (RS-232C) port can be used to output Station Message Detail Recording (SMDR) data to a PC, printer, etc.

2. SMDR Output Data

The following data can be logged and sent to the SMDR output port:

- a)** Outside (CO) line call information (incoming/outgoing)
- b)** Call charge information (outgoing)

Memory for SMDR: A limited number of call records can be stored in the PBX. If the memory becomes full, the oldest call will be overwritten each time a call is received.

When an optional message expansion card for DISA/UCD OGMs is installed, the number of calls that can be stored increases from 64 to 10 000.

3. SMDR Format and Contents

[Example]

Pattern A: Without call charge information

Date	Time	Ext.	CO	Dial number	Duration	Code
12/31/05	12:52PM	103	05	12345678901234567890123456789012	00:00'16"
12/31/05	12:53PM	103	02	< incoming >2013570846	00:01'43"
12/31/05	*12:54PM	101	02	< incoming >2013570846	00:07'48"
12/31/05	12:55PM	101B	02	< BV incoming >2013570846	00:00'43"
12/31/05	12:56PM	107B	03	< DIL incoming >0921234557	00:01'43"
12/31/05	1:04PM	103	06	092... 1438	00:00'06"	4536
12/31/05	1:04PM	102	05	< DISA incoming >2013570846	00:00'09" 0
12/31/05	1:05PM	103	01	< DISA incoming >	00:00'08" 0
12/31/05	1:06PM	103	01	092123456789	00:00'08"
12/31/05	1:06PM	C-05	02	0921234567	00:00'17" 2
12/31/05	1:07PM	103	01	0921234567	00:11'00"	..13
12/31/05	2:15PM	103	01	0921234567	00:11'00"	.101
12/31/05	2:26PM	103	01	F/0927654321	00:03'00"	.101
12/31/05	2:27PM	116	05	9=0924567123	00:13'55"
12/31/05	3:25PM		02	< UCD waiting >	00:11'48"

(1)
(2)
(3)
(4)
(5)
(6)
(7)

Pattern B: With call charge information

Date	Time	Ext.	CO	Dial number	Duration	Charge	Code
12/31/05	12:52PM	103	05	123456789012345678901234	00:00'16"	0.04 EUR
12/31/05	12:53PM	103	02	< incoming >	00:01'43"	
12/31/05	*12:54PM	101	02	< incoming >	00:07'48"	
12/31/05	12:55PM	101B	02	< BV incoming >	00:00'43"	
12/31/05	12:56PM	107B	03	< DIL incoming >	00:01'43"	
12/31/05	1:04PM	103	06	092... 1438	00:00'06"	0.02 EUR	4536
12/31/05	1:04PM	102	05	< DISA incoming >	00:00'09"	 0
12/31/05	1:05PM	103	01	< DISA incoming >	00:00'08"	 0
12/31/05	1:06PM	103	01	092123456789	00:00'08"	0.02 EUR
12/31/05	1:06PM	C-05	02	0921234567	00:00'17"	0.04 EUR 2
12/31/05	1:07PM	103	01	0921234567	00:11'00"	0.55 EUR	..13
12/31/05	2:15PM	103	01	0921234567	00:11'00"	0.55 EUR	.101
12/31/05	2:26PM	103	01	F/0927654321	00:03'00"	0.15 EUR	.101
12/31/05	2:27PM	116	05	9=0924567123	00:13'55"	0.67 EUR
12/31/05	3:25PM		02	< UCD waiting >	00:11'48"	

(1)
(2)
(3)
(4)
(5)
(6)
(8)
(7)

1.20 Administrative Information Features

[Explanation]

The following table explains the types of data logged by SMDR. The section numbers below refer to the field indicated by the numbers above.

Section Number	Data	Description
(1)	Date	Shows the date (Month/Day/Year) of the call (→ Date & Time [000]). The date order varies depending on the user's country/area.
(2)	Time	Shows the start time of a call as hour/minute/AM or PM. Also shows the following code: *: Transferred call (→ 1.11.1 Call Transfer)
(3)	Ext. (Extension)	Shows the number of the extension that was engaged in the call. Also shows the following codes: xxxB : Call answered by the BV feature (→ 1.15.7 Built-in Voice Message (BV)) (xxx=Number of the extension to which the call was directed before the BV feature answered) Even if a caller does not leave a voice message, for example, by going on-hook while hearing a personal/common BV outgoing message (OGM), the information is logged. C-xx : Outside-to-Outside (CO-to-CO) line call via the DISA feature (→ 1.15.6 Direct Inward System Access (DISA)) (xx=Outside (CO) line number that receives the DISA call)
(4)	CO	Shows the outside (CO) line number used for the call.

Section Number	Data	Description
(5)	Dial number	<p>[Outside (CO) Line Call]</p> <p>Outgoing Outside (CO) Line Call Shows the dialled telephone number*1. Digits shown are as follows:</p> <p>0 through 9, *, #, - (hyphen) F/: Flash/recall signal (→ 1.10.6 Flash/Recall) =: Host PBX Access code marker (→ 1.5.2.8 Host PBX Access Code (Access Code to the Telephone Company from a Host PBX)) The marker is displayed between the Host PBX Access code and the dialled number when a Host PBX Access code is entered. . (dot): Secret Dialling</p> <p>Incoming Outside (CO) Line Call Shows <incoming> + the caller's telephone number (max. 16 digits). A caller's telephone number is displayed only when an optional Caller ID card is installed and "With CID" is selected in Caller ID SMDR Format [906]. It is also possible to show a caller's telephone number before the call is answered (→ Caller ID SMDR Printout [907]).</p> <p>Also shows the following codes: <DISA incoming>: Incoming outside (CO) line call via the DISA feature <BV incoming>: Incoming outside (CO) line call to the common message area of the BV feature <DIL incoming>: Incoming outside (CO) line call via the DIL feature (→ 1.1.1.1 Direct In Line (DIL)) <UCD waiting>: Incoming outside (CO) line call via the UCD feature (→ 1.2.2 Uniform Call Distribution (UCD)) When the UCD waiting call is answered, a new record is started.</p>
(6)	Duration	Shows the duration of the outside (CO) line call or the UCD call waiting time in hours/minutes/seconds.
(7)	Code	<p>Shows the account code appended to the call (→ 1.5.2.3 Account Code Entry), the account code index number (e.g., 13), the number of the extension that used the Walking COS feature (e.g., 101), or DISA security code status (e.g., 0).</p> <p>0: A DISA incoming call without a DISA security code 1 to 4: A DISA incoming call with a DISA security code number Actual DISA security codes are not printed by SMDR (→ DISA Security Code [512]).</p>

1.20 Administrative Information Features

Section Number	Data	Description
(8)	Charge	Shows the call charge of the outside (CO) line call (→ Call Charge Calculation [441]). Up to 3 currency characters (e.g., EUR for Euro) can be assigned through system programming (→ Currency [921]). The charge can consist of up to 7 digits (e.g., 88888.75), and the number of decimal places can be assigned through system programming (→ 1.20.2 Call Charge Calculation).

*1 A maximum of 32 digits can be shown when "Without Charge" is selected in Call Charge Information SMDR Format 1 [922]. If "With Charge" is selected, the maximum is 24 digits.

The following data can be controlled through system programming to adjust whether (or how) they are printed or displayed by SMDR.

[Programmable Items]

Item	Description
Incoming/Outgoing outside (CO) line call	Controls whether incoming/outgoing outside (CO) line calls are shown (→ Incoming/Outgoing Call Selection for Printing [802]). Even if "On" or "Toll" is selected for outgoing outside (CO) line calls or even if "On" is selected for incoming outside (CO) line calls, when "MODE 2" is selected in SMDR Mode for Printing [929], the call log information is not displayed by SMDR, but the information for each extension is displayed by Call Log Printout. If "Toll" is selected for outgoing outside (CO) line calls, only calls that are checked in TRS—COS 2-5 Denied Code [302-305] and are allowed, are shown.
Caller's identification	Controls whether a caller's telephone number is shown (→ Caller ID SMDR Format [906]). When this is set to display telephone numbers, even if the PBX receives a caller's name by the Caller ID feature, only the telephone number is shown.
Secret Dialling	Controls whether a secret dialling number stored in System Speed Dialling Number [001] or stored as a One-touch Dialling button is shown by SMDR (→ Secret Number SMDR Print Suppression [803]).
Account Code	Controls whether the account code stored in Account Code [310] or just the index of the account code is shown (→ SMDR Account Code [805]). The index of the account code is shown when "Verify-All" or "Verify-Toll" is selected in Account Code Mode [605].
Call Charge	Controls whether the charge for outside (CO) line calls is shown or not (→ Call Charge Information SMDR Format 1 [922]), or whether nonessential zeros that precede the charge are shown by SMDR (→ Call Charge Information SMDR Format 2 [923]).

Item	Description
System programming items	<p>Controls whether system programming items that have already been assigned are shown based on the following parameters (→ System Data Dump [804]):</p> <ul style="list-style-type: none"> a) All para: All data b) System para: All data except for "CO para", "Extn. para", "DSS para" and "Speed dial" c) CO para: The data assigned for each outside (CO) line d) Extn. para: The data assigned for each extension e) DSS para: The data assigned on the Direct Station Selection (DSS) buttons and Programmable Feature (PF) buttons on the DSS Console f) Speed dial: The System Speed Dialling numbers and names in System Speed Dialling Number [001] and System Speed Dialling Name [011] g) Stop output: Not shown

Conditions

- SMDR data is not deleted even if the PBX is restarted. It is cleared when output via RS-232C to a PC, printer, etc., or by performing System Data Clear.
- **Multilingual Display by SMDR**
It is possible to select the display language used for SMDR through system programming (→ SMDR Language [806]).
- The PBX waits for a preprogrammed length of time (→ Call Duration Counter Start [204]) after the end of seizing an outside (CO) line or dialling, before starting the call duration counter for outgoing outside (CO) line calls. When the PBX has sent out all dialled digits to the telephone company and this timer expires, the PBX begins measuring the duration of the call. A display proprietary telephone (PT) shows the elapsed time of the call. The starting time and the total duration of the call are logged by SMDR. If Reverse Signal Detection is enabled for an outside (CO) line (→ Polarity Reverse Detection [424]), the PBX will start the call duration counter immediately after the outside party answers the call.
- **For SMS users**
When an SLT user makes an SMS centre call (→ 1.17.3 Fixed Line SMS Terminal Support), in some cases the duration of the call may not be verified with SMDR, because it takes very little time to send SMS messages. To verify the duration of these calls, it is recommended to set the start timer of call duration to "5 s" or "Instantly" through system programming (→ Call Duration Counter Start [204]).
- **SMDR Format**
The following SMDR format parameters can be set through system programming (→ SMDR Parameter [801]) in order to match the paper size being used by the printer:
 - a) Page Length:** determines the number of lines per page.
 - b) Skip Perforation:** determines the number of lines to be skipped at the end of every page.

The page length should be at least 4 lines longer than the skip perforation length.
The title is placed on the first 3 lines of every page.
To enable the changes, you must turn the power switch of the PBX off and back on again after changing this setting.

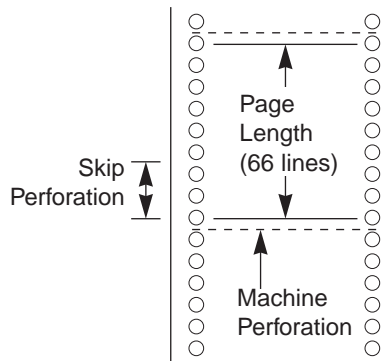

- **Serial Interface (RS-232C) Parameters**

The following communication parameters can be assigned for the Serial Interface (RS-232C) port through system programming (→ SMDR RS-232C Parameter [800]):

- a) **New Line (NL) Code:** Select the code appropriate for the PC or printer. If the PC or printer automatically feeds lines with carriage return, select "CR". If not, select "CR+LF".
 - b) **Baud Rate:** Baud rate indicates the transmission speed of data from the PBX to the PC or printer.
 - c) **Word Length:** Word length indicates how many bits compose each character.
 - d) **Parity Bit:** Parity bit indicates what type of parity is used to detect errors in the string of bits composing a character. Make an appropriate selection depending on the requirements of the PC or printer.
 - e) **Stop Bit Length:** Stop bit indicates the end of a bit string that composes a character. Select an appropriate value depending on the requirements of the PC or printer.
- The codes for "**Dial number**" will be abbreviated as shown below, if all of the following conditions are met:
 - an optional Caller ID card is installed.
 - "With CID" is selected in Caller ID SMDR Format [906].
 - "With Charge" is selected in Call Charge Information SMDR Format 1 [922].

Abbreviation of codes:

- <incoming> → <I>
- <DISA incoming> → <DI>
- <BV incoming> → <BI>
- <DIL incoming> →
- <UCD waiting> → <UW>

- If the charge of a call exceeds 7 digits, considering that the decimal point does not move, all numbers will be replaced by nines (e.g., 99999.99).
- Before changing the decimal point position (→ Decimal Places [190]), output or clear all SMDR data. Otherwise, the charge value for the accumulated data will be displayed incorrectly.

Installation Manual References

- 2.3.8 Message Expansion Card for DISA/UCD OGMs (KX-TE82491)
- 2.8.1 Connecting Peripherals
- 4.1.5 System Reset with System Data Clear

1.20.1.2 Call Log Printout for Each Extension

Description

Calls can also be logged according to which extension they were made from, and printed out. An extension assigned as the manager extension can use the following features through manager programming:

- a) Call Log Print Out and Clear, for Each Extension
- b) All Clear

[Example]

The manager can print out call logs for each extension. Up to 500 outgoing outside (CO) line calls can be logged in the PBX. When an optional message expansion card for DISA/UCD OGMs is installed, the number of calls that can be stored increases to 10 000. If the memory becomes full, the oldest call will be overwritten each time a call is received.

Calls stored since the manager cleared the call log for an extension can be printed out.

* 103 : Tony Viola *								

(1)	Starting Date	:	Dec.29.05	07:00PM**				
	Present Date	:	Dec.31.05	09:00PM				
Date	Time	Ext.	CO	Dial number	Duration	Charge	Code	
12/31/05	*12:52PM	103	05	123456789012345678901234	00:00'16"	0.04 EUR	
12/31/05	1:04PM	103	06	092...1438	00:00'06"	0.02 EUR	4536	
12/31/05	1:06PM	103	01	092123456789	00:00'08"	0.02 EUR	
12/31/05	1:07PM	103	01	0921234567	00:11'00"	0.55 EUR	..13	
12/31/05	2:15PM	103	01	0921234567	00:11'00"	0.55 EUR	.101	
12/31/05	2:26PM	103	01	F/0927654321	00:03'00"	0.15 EUR	.101	
Total						1.33 EUR		

(2)

(1) **"Starting Date"** shows the start date (Month/Day/Year) of the call log. "***" indicates that there may be overwritten calls that are not shown on the print out. In this case, the total of the shown call charges may be different from the actual total charge. The total charge under the line is the correct one. The date format varies depending on the user's country/area.

(2) **"Charge"** shows the call charge when Call Charge Calculation is enabled (→ Call Charge Calculation [441]) and "With Charge" is selected (→ Call Charge Information SMDR Format 1 [922]) through system programming. A call charge of up to 7 digits is shown for each call, and the Total can consist of up to a maximum of 17 digits including whole numbers (max. 10 digits), the decimal point, and a preprogrammed number of decimal digits (max. 6 digits) (→ Decimal Places [190]). If the call charge exceeds the maximum number of digits, considering that the decimal point does not move, all numbers will be replaced by nines.

Conditions

- Call Log Printout data is not deleted even if the PBX is restarted. It is cleared through manager programming or by performing System Data Clear.
- Even if an extension user holds a call, the duration of the call will be counted. If an extension user transfers the call, the count of duration will restart at the destination extension.

1.20 Administrative Information Features

- **SMDR Mode for Printing**

One of the following modes can be selected through system programming (→ SMDR Mode for Printing [929]):

- a) **MODE 1**

Outside (CO) line call information is displayed by SMDR (→ 1.20.1.1 Station Message Detail Recording (SMDR)), and call log information for each extension is displayed by Call Log Printout.

- b) **MODE 2**

Only call log information for each extension is displayed by Call Log Printout.

- It is possible to control whether a secret dialling number stored in System Speed Dialling Number [001] or stored as a One-touch Dialling button is shown by Call Log Printout (→ Secret Number SMDR Print Suppression [803]). When "No Printing" is selected, numbers dialled secretly will be shown as dots.
- It is possible to control whether "**Dial number**" is shown by Call Log Printout (→ Secret Printing [924]).
- Before changing the decimal point position (→ Decimal Places [190]), clear all Call Log Printout data. Otherwise, the charge value for the accumulated data will be displayed incorrectly.

Installation Manual References

2.3.8 Message Expansion Card for DISA/UCD OGMs (KX-TE82491)

4.1.5 System Reset with System Data Clear

User Manual References

3.2.2 Managing Call Logs and Call Charges

1.20.2 Call Charge Calculation

Description

The PBX can calculate call charges for outside (CO) line calls to preprogrammed destinations. The call charge information can be shown on SMDR and the display of proprietary telephones (PTs).

Note

This feature is a simple estimation of call charges and will not necessarily match the charges billed by your telephone company.

[Programming Procedures]

1. Call Charge Calculation

Turn on Call Charge Calculation for each outside (CO) line to enable this feature (→ Call Charge Calculation [441]).

2. Time Table

Since the charge of a call may vary depending on the time of day and the day of the week, 3 call charge rates, Peak/Off Peak/Economy, can be assigned for each hour of each day of the week.

Up to 4 different Time Tables can be programmed (→ Call Charge Calculation—Time Table 1/2/3/4 [162/169/176/183]). Which Time Table is applied to a certain call is decided by the outside (CO) line carrying the call (→ Call Charge Table Assignment [442]).

3. Call Charge Table

A total of 100 leading numbers*1 (Max. 10 digits) can be stored as destinations to decide how a call is charged for each call charge rate (Peak/Off Peak/Economy). A leading number can have different values in each of the 4 tables. Which Call Charge Table is applied to a certain call is decided by the outside (CO) line carrying the call (→ Call Charge Table Assignment [442]).

The values to be set for each call charge rate are as follows*2:

- Flat Charge
- Flat Duration
- Unit Charge
- Unit Duration

*1 → Call Charge Calculation—Registering Leading Numbers [161]

*2 → Call Charge Table 1/2/3/4—Peak Flat Charge and Duration [163/170/177/184],
Call Charge Table 1/2/3/4—Peak Unit Charge and Duration [164/171/178/185],
Call Charge Table 1/2/3/4—Off Peak Flat Charge and Duration [165/172/179/186],
Call Charge Table 1/2/3/4—Off Peak Unit Charge and Duration [166/173/180/187],
Call Charge Table 1/2/3/4—Economy Flat Charge and Duration [167/174/181/188],
Call Charge Table 1/2/3/4—Economy Unit Charge and Duration [168/175/182/189]

[Programming Example]

<Table Selection>

Outside (CO) Line No.	Table No.
1	1
2	3
(Cont.):	:
:	:

<Time Table>

		Time Table 1											
Week		12	1	2	3	4	5	6	7	8	9	10	11
Sunday	AM	E	E	E	O	O	O	O	O	O	O	O	O
	PM	O	O	O	E	E	E	E	P	P	P	P	P
Monday	AM	E	E	E	P	P	O	O	O	O	O	O	O
	PM	E	E	E	E	P	P	P	P	P	P	P	P
(Cont.):	:	:	:	:	:	:	:	:	:	:	:	:	:
:	:	:	:	:	:	:	:	:	:	:	:	:	:
Saturday	AM	E	E	E	E	E	E	E	E	E	E	E	E
	PM	E	E	E	E	E	E	E	E	E	E	E	E

P: Peak O: Off Peak E: Economy

<Call Charge Table>

Location No.	Leading No.	Call Charge Table 1					
		Peak		Off Peak		Economy	
		Flat Charge and Duration	Unit Charge and Duration	Flat Charge and Duration	Unit Charge and Duration	Flat Charge and Duration	Unit Charge and Duration
00	013	70 / 60 s	40 / 30 s	50 / 60 s	30 / 30 s	40 / 60 s	25 / 30 s
01	012						
02	02						
03	03	100 / 180 s	50 / 30 s	20 / 40 s	10 / 50 s	20 / 40 s	10 / 60 s
(Cont.):	:	:	:	:	:	:	:
:	:	:	:	:	:	:	:
99	099	100 / 180 s	50 / 30 s	20 / 40 s	10 / 50 s	20 / 40 s	10 / 60 s

Note

If the dialled number does not match any Leading Number stored in the call charge table, the call charge for location number "99" is applied to the call. Therefore it is necessary to set the values for location number "99".

4. Calculation Method

The call charge is calculated based on the following graph:

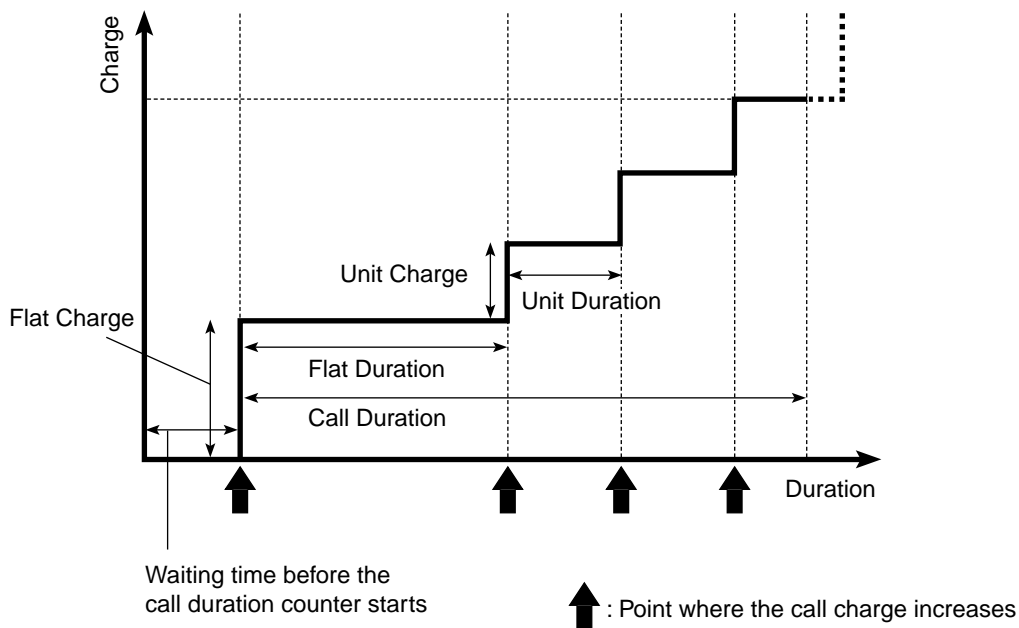

a) If the Call Duration is less than the Flat Duration:

$$\text{Call Charge} = \text{Flat Charge}$$

b) If the Call Duration is more than the Flat Duration:

$$\text{Call Charge} = \text{Flat Charge} + \text{Unit Charge} + \text{Unit Charge} \times \text{Whole Number Part of } \frac{\text{Call Duration} - \text{Flat Duration}}{\text{Unit Duration}}$$

[Programming Example] (Using the example shown in "3. Call Charge Table")

If the dialled number is "03XXXX", and the call is made at Peak time.

a) If the Call Duration is 160 s:

$$\text{Call Charge} = \frac{100}{\text{Flat Charge}}$$

b) If the Call Duration is 250 s:

$$\text{Call Charge} = \frac{100}{\text{Flat Charge}} + \frac{50}{\text{Unit Charge}} + \frac{50}{\text{Unit Charge}} \times \frac{2}{\text{Unit Duration}} = 250$$

$$\frac{\text{Call Duration} - \text{Flat Duration}}{\text{Unit Duration}} = \frac{250 - 180}{30} = 2.333\dots$$

5. Call Charge Display

Information about the call charge can be shown on the display of a PT. The display can contain up to 3 characters (e.g., EUR for Euro) for the currency (→ Currency [921]) and up to 7 digits, excluding the decimal point, for each call charge. The decimal point position (the number of significant decimal digits) for the charge can also be programmed (→ Decimal Places [190]). Additionally, the order in which information is displayed can be programmed (→ LCD Display Mode [630]). For more information, refer to "1.18.4 Display Information".

6. Budget Management

It is possible to limit telephone usage to a preprogrammed budget on each extension (→ Budget Management [925]). For example, an extension in a rented office may have a prepaid limit for telephone usage. If the total of call charges reaches the limit, the extension user cannot make further outside (CO) line calls (→ Budget Limit Selection [926]). An extension assigned as the manager can increase the limit or clear the previous call charges. For more information, refer to "1.8.3 Budget Management".

7. Call Charge Management

An extension assigned as the manager extension can access the following features through manager programming:

- a. Call Charge Reference and Clear, for Each Extension/Each Outside (CO) Line/Account Code
- b. All Clear

- c. Call Charge Print Out
- d. Budget Management for Each Extension (→ 1.8.3 Budget Management)

[Example of Call Charge Reference]

Call Log Printout for Each Extension:

```

*****
*           103 : Tony Viola           *
*****
Starting Date   : Dec.29.05 07:00PM**
Present Date    : Dec.31.05 09:00PM

  Date   Time   Ext. CO           Dial number           Duration           Charge           Code
-----
12/31/05 *12:52PM 103 05   123456789012345678901234   00:00'16"         0.04 EUR         ....
12/31/05  1:04PM 103 06   092...1438                 00:00'06"         0.02 EUR         4536
12/31/05  1:06PM 103 01   092123456789              00:00'08"         0.02 EUR         ....
12/31/05  1:07PM 103 01   0921234567                00:11'00"         0.55 EUR         ..13
12/31/05  2:15PM 103 01   0921234567                00:11'00"         0.55 EUR         .101
12/31/05  2:26PM 103 01   F/0927654321              00:03'00"         0.15 EUR         .101
-----
                                           Total                 1.33 EUR
    
```

Conditions

- When searching for a Leading Number in a Call Charge Table, the PBX checks only the dialled telephone number, excluding Carrier Exception codes (→ Carrier Exception Code [300]), Host PBX Access codes (→ Host PBX Access Code [403]), and 1st Carrier Selection code (→ 1st Carrier Selection Code [359]).
- When the dialled number matches several Leading Numbers in the Call Charge Table, the location with the longest matching number is selected.
- The PBX only checks the numbers dialled within a preprogrammed length of time (→ Call Duration Counter Start [204]). The rest of the numbers are not applied for the Leading Number check.

[Example]

<Call Charge Table>

Location No.	Leading No.	Call Charge Table 1	
		Peak	
		Flat Charge and Duration	Unit Charge and Duration
00	014	50 / 60 s	30 / 30 s
01	01	45 / 60 s	25 / 30 s
(Cont.):	:	:	:
:	:	:	:

In this example:

When dialling "014XXXX" and "4" is dialled after the Call Duration Counter Start [204], location number "01" will be selected. SMDR shows "014XXXX" as the "Dial number".

- To increase the accuracy of Call Charge Calculation, match the Call Duration Counter Start [204] timer with your telephone company's inter-digit timer.
- The call charge rate (Peak/Off Peak/Economy) when a call is established is used to calculate the call charge.
- If Reverse Signal Detection is enabled for an outside (CO) line (→ Polarity Reverse Detection [424]), the PBX will start the call duration counter (→ Call Duration Counter Start [204]) immediately after the

outside party answers the call.

Note that Call Charge Calculation will not function if the call duration counter is set to "Instantly" when Reverse Signal Detection is disabled.

- When a call is disconnected due to the Extension-to-CO Line Call Duration [212] timer, if the call charge is set to increase at the same time as disconnection, the increase will not be registered by the PBX.
- When Flat Duration is set to "0", the total of the Flat Charge and Unit Charge is charged immediately after the preprogrammed length of time (→ Call Duration Counter Start [204]) or the outside party answers the call.

When Unit Duration is set to "0", the Flat Charge is charged immediately after the preprogrammed length of time or the outside party answers the call. Then, the Unit Charge is charged just once, when the Flat Duration expires.

[Example]

a) Flat Duration: 0 s; Flat Charge: 0; Unit Duration: 60 s; Unit Charge: 10

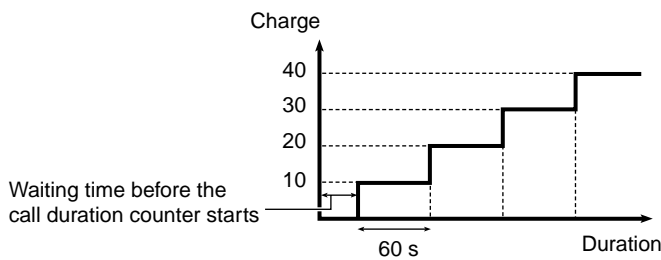

b) Flat Duration: 0 s; Flat Charge: 100; Unit Duration: 60 s; Unit Charge: 10

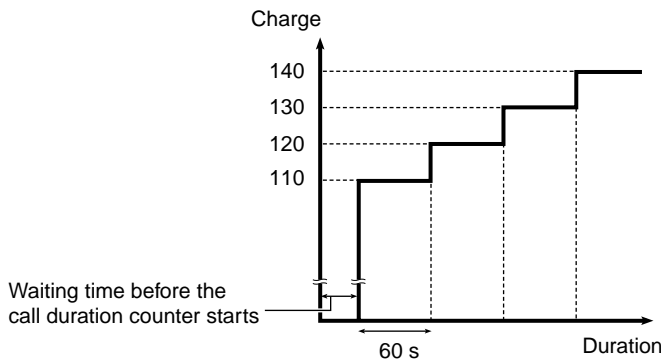

c) Flat Duration: 0 s*; Flat Charge: 10; Unit Duration: 0 s*; Unit Charge: 0
 * In this case, Flat Duration and Unit Duration could be any value.

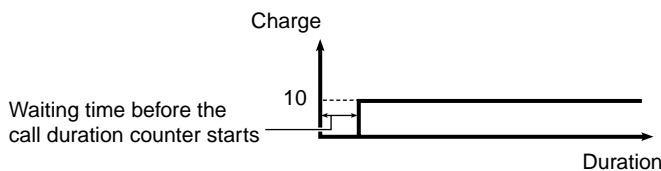

d) Flat Duration: 60 s; Flat Charge: 10; Unit Duration: 0 s; Unit Charge: 100

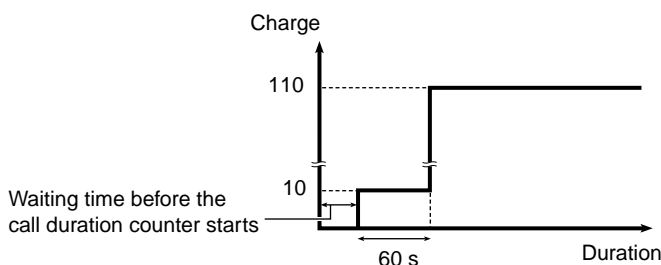

1.20 Administrative Information Features

- Flat Charges and Unit Charges for each call charge rate (Peak/Off Peak/Economy) consist of up to 7 digits excluding the decimal point (e.g., 12345.67).
- The charge of a call can consist of no more than 7 digits. For example, if the number of decimal places (→ Decimal Places [190]) is set to 3, the maximum call charge will be calculated as 9 999.999 even if the actual charge exceeds this.
- To log the charge of calls on SMDR, "With Charge" must be selected in Call Charge Information SMDR Format 1 [922]. Whether nonessential zeros that precede the charge are shown can be programmed in Call Charge Information SMDR Format 2 [923].
- It is possible to control whether "**Dial number**" is shown by Call Log Printout (→ Secret Printing [924]).

User Manual References

3.2.2 Managing Call Logs and Call Charges

1.21 Extension Controlling Features

1.21.1 Extension Feature Clear

Description

Extension users can simultaneously clear all of the following features set on their own telephone:

Feature	Value after Extension Feature Clear
Absent Message	Off
Automatic Callback Busy	Off
Background Music (BGM)	Off
Call Forwarding (FWD)	Off
Call Pickup Deny	Allow
Call Waiting	Disable
Data Line Security	Off
Do Not Disturb (DND)	Off
Executive Busy Override Deny	Allow
Hot Line	The stored telephone numbers will be cleared.
Log-in/Log-out	Log-in
Message Waiting	All messages left by other extensions will be cleared.
Paging Deny	Allow
Room Monitor	Off
Timed Reminder	Cleared
Voice Mail Integration	Off

This feature is also known as Station Feature Clear or Station Programme Clear.

User Manual References

1.7.8 Clearing Features Set at Your Extension (Extension Feature Clear)

1.21.2 Timed Reminder

Description

Each extension user can set an alarm to be used as a wake-up call or reminder. This feature can be programmed to activate daily or one time only. If the user goes off-hook during the alarm, a special dial tone (dial tone 3) will be heard.

Remote Timed Reminder

An extension assigned as the operator or manager extension can remotely set, cancel, and confirm the timed reminder of the desired extension. This feature is useful, for example, for a small hotel or motel to set a wake-up call for an extension in a guest room, or for a parent to set a wake-up call for an extension in a child's room.

Conditions

- Be sure that the PBX clock is set to the correct time.
- Setting a new alarm time clears the previous alarm time.
- There is no limit for the number of the extensions that can set Timed Reminder at the same time.

User Manual References

1.7.1 Setting the Alarm (Timed Reminder)

2.1.3 Setting an Alarm for Other Extensions (Remote Timed Reminder [Wake-up Call])

1.22 Audible Tone Features

1.22.1 Dial Tone

Description

The following dial tones inform extension users about features activated on their extensions:

Type	Description
Tone 1	A normal dial tone is heard when none of the features listed for dial tones 2 through 5 have been set.
Tone 2	Heard when any of the following features is set. <ul style="list-style-type: none"> • Absent Message • Background Music (BGM) (for proprietary telephones [PTs] only) • Call Forwarding (FWD) • Call Pickup Deny • Data Line Security • Do Not Disturb (DND) • Extension Lock • Hot Line (for single line telephones [SLTs] only) • Message Waiting (for PTs only) • Remote Extension Lock • Timed Reminder
Tone 3	Heard when any of the following features is performed. <ul style="list-style-type: none"> • Account Code Entry • Answering a call from Timed Reminder • Going off-hook with an SLT that has messages waiting
Tone 4	Heard when going off-hook if new voice messages have been recorded (Built-in Voice Message [BV]).
Tone 5	Heard when going off-hook if the remaining voice message recording time is less than 5 minutes or if 125 voice messages have been recorded (Built-in Voice Message [BV]).

Conditions

- **Dial Tone Type for ARS/Account Code Entry (Verify-Toll mode only)**
Through system programming, it is possible to select the dial tone type for the Automatic Route Selection (ARS)/Account Code Entry (Verify-Toll mode only) feature (→ ARS Dial Tone [362]).

Feature Guide References

4.2.1 Tones/Ring Tones

1.22.2 Confirmation Tone

Description

At the end of a feature operation, the PBX confirms the success of the operation by sending a confirmation tone to the extension user.

Type	Description
Tone 1	Sent when the setting is accepted, or sent when the Extension Lock feature is set or cancelled.
Tone 2	Sent when the new setting is identical to the previous one, or sent when certain features are successfully performed or accessed (e.g., Call Hold, Automatic Callback Busy).
Tone 3	Sent before a conversation is established when accessing the following features: <ul style="list-style-type: none">• Call Pickup• Call Hold Retrieve with the Feature Number• Conference• Paging/Paging Answer

Conditions

- It is possible to eliminate confirmation tone 3 (except for Call Hold Retrieve with the Feature Number) through system programming (→ Call Pickup Tone [117], Conference Tone [105], External Pager Access Tone [106]).

Feature Guide References

4.2.1 Tones/Ring Tones

Section 2

System Configuration and Administration Features

2.1 System Configuration—Hardware

2.1.1 Extension Jack Configuration

Description

Extension jacks are used to connect proprietary telephones (PTs), single line telephones (SLTs), Direct Station Selection (DSS) Consoles, and Voice Processing Systems (VPSs) to the PBX.

Conditions

- **PT and SLT in Parallel Mode**
A PT and an SLT can be connected to an extension jack and used in parallel mode.
- **DSS Console and Paired Telephone Assignment**
When a DSS Console is connected, a PT must be paired with the DSS Console through system programming (→ DSS Console Jack Assignment [003], Console Paired Telephone [004]). Each extension jack number should be unique.
- **Automatic Detection**
A PT and an SLT can be connected to an extension jack with no programming required.

2.2 System Configuration—Software

2.2.1 Class of Service (COS)

Description

Each extension is assigned a class of service (COS) number (→ TRS-COS—Day/Night/Lunch [601-603]). The following features operate differently depending on an extension's COS.

- a) TRS (→ 1.8.1 Toll Restriction (TRS))
- b) Walking COS (→ 1.8.5 Walking COS)

Conditions

- **Walking COS**
An extension user can make a call from an extension with a lower COS by using his or her own COS temporarily.

User Manual References

- 1.2.6 Using Your Calling Privileges at Another Extension (Walking COS)

2.2.2 Group

Description

This PBX supports various types of groups.

1. Outside (CO) Line Group

Outside (CO) lines can be grouped into 8 outside (CO) line groups based on properties such as carrier or outside (CO) line type (→ CO Line Group Number [404]). Each outside (CO) line can belong to only one outside (CO) line group.

2. Extension Group

Extensions can be grouped into 8 extension groups (→ Extension Group [600]). Each extension group can have the following attribute set:

- a) Call Pickup Group
- b) Paging Group
- c) Idle Extension Hunting Group
- d) Uniform Call Distribution (UCD) Group
- e) Direct Inward System Access (DISA) Ring Group

Every extension must belong to one extension group and cannot belong to more than one extension group.

Assignable Extensions: Proprietary telephones (PTs)/single line telephones (SLTs)

[Example]

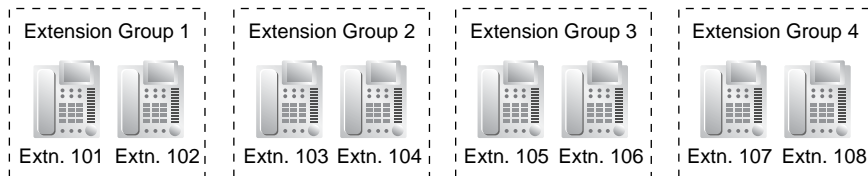

2.1. Call Pickup Group

Using the Call Pickup feature, extensions can answer any calls within the call pickup group to which they belong.

2.2. Paging Group

Using the Paging feature, extensions can make a page to any paging group, or answer a page made to any group.

2.3. Idle Extension Hunting Group

If a called extension is busy, Idle Extension Hunting redirects the incoming call to an idle member of the same extension group (→ Hunting Group Set [100]). When calls are received, idle extensions are automatically searched for according to a preprogrammed hunting type (→ Hunting Type [101]): Circular Hunting or Terminated Hunting.

2.4. Uniform Call Distribution (UCD) Group

A UCD group is a group of extensions that receives UCD calls directed to the group (→ UCD Group [520]). To use this feature, "UCD" must be selected as the distribution method for the desired outside (CO) line port (→ CO Line Mode—Day/Night/Lunch [414-416]).

2.5. Direct Inward System Access (DISA) Ring Group

A DISA ring group is a specific extension group that receives DISA calls directed to the group. All extensions in the group assigned as an Automated Attendant (AA) destination (→ DISA Built-in AA [501]) ring simultaneously. To use this feature, "DISA" must be selected as the distribution method for the desired outside (CO) line port (→ CO Line Mode—Day/Night/Lunch [414-416]) and "With AA" must be selected as the destination of incoming outside (CO) line calls via the DISA feature (→ DISA Incoming Call Dial Mode [500]).

Feature Guide References

- 1.2.1 Idle Extension Hunting
- 1.2.2 Uniform Call Distribution (UCD)
- 1.2.3 Direct Inward System Access (DISA) Ring
 - 1.4.1.3 Call Pickup
 - 1.14.1 Paging

2.2.3 Time Service

Description

Time service modes are used by many PBX features to determine how they will function during different times of day. For example, incoming calls can be directed to sales staff during the day and to a Voice Processing System (VPS) at night, extension users can be prohibited from making long-distance calls during lunch time, etc.

There are 3 time service modes—day, night, and lunch. The start times of each time service mode and end time of lunch mode are programmed for each day of the week in a Time Table.

1. Time Service Switching Mode

The current time service mode can switch automatically to another time service mode at the time assigned in the Time Table. It is possible, however, to switch time service modes manually.

Whether time service modes are normally switched manually or automatically is determined through system programming (→ Time Service Switching Mode [006]).

Switching Mode	Description	Condition
Automatic	The current time service mode will switch automatically to another time service mode at the time assigned in the Time Table, and can be switched manually by pressing the Day, Night, or Lunch button or by entering the Time Service feature number.	The current time service mode (day/night/lunch) and the switching mode (automatic/manual) can be switched manually by an extension assigned as the operator or manager extension.
Manual	The current time service mode will switch only when the Day, Night, or Lunch button is pressed or when the Time Service feature number is entered.	

2. Time Table

A Time Table has 3 modes—day, night, and lunch. A Time Table can be programmed to control when each time service mode starts (and therefore, the previous time service mode ends), and can be programmed separately for each day of the week.

[Programming Example: Time Table]

Time Schedule*	Day	Night	Lunch	
	Start Time	Start Time	Start Time	End Time
Sunday	Not Stored	Not Stored	Not Stored	Not Stored
Monday	09:00	17:00	12:00	13:00
Tuesday	09:00	17:00	12:00	13:00
(Cont.) :	:	:	:	:
:	:	:	:	:

* → Time Service Start Time [007]

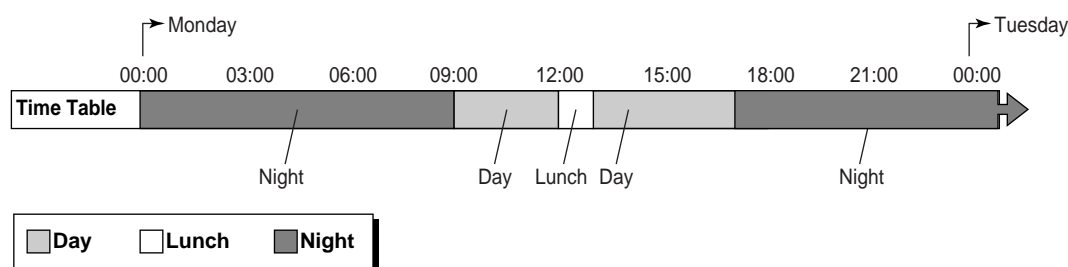
[Visualisation of Time Schedule]

Note that time service modes can be arranged as they are needed (for example, night mode can occur in the morning and afternoon, if necessary) and not all time service modes need to be used in a time schedule. Also note that day mode or night mode resumes automatically when lunch mode ends.

3. Programming Items Using Time Service

The following programming items will be affected by the time service:

- a) Flexible Outward Dialling—Day/Night/Lunch [405-407]
- b) Flexible Ringing—Day/Night/Lunch [408-410]
- c) Delayed Ringing—Day/Night/Lunch [411-413]
- d) CO Line Mode—Day/Night/Lunch [414-416]
- e) DRD Ring Pattern 2 Extension Assignment—Day/Night/Lunch [427-429] (New Zealand only)
- f) DRD Ring Pattern 3 Extension Assignment—Day/Night/Lunch [430-432] (New Zealand only)
- g) DISA IRNA to BV—Day/Night/Lunch [438-440]
- h) TRS-COS—Day/Night/Lunch [601-603]
- i) Doorphone Ringing—Day/Night/Lunch [700-702]
- j) Door Opener—Day/Night/Lunch [703-705]

4. Day/Night/Lunch Button

A flexible Direct Station Selection (DSS) button can be customised as a Day, Night, or Lunch button by the operator or manager.

These buttons can be used to switch the current time service mode.

Each button shows the current status as follows:

Light Pattern	Status
Off	Day/Night/Lunch off
Red on	Day/Night/Lunch on

Note

Extension users can press the "#" key on their proprietary telephones (PTs) to display the current time service mode.

Conditions

- The start times of each time service mode and end time of lunch mode can be specified through system programming (→ Time Service Start Time [007]).

Feature Guide References

1.18.2 Flexible Buttons

User Manual References

1.7.7 Checking the Time Service Mode

2.1.2 Switching the Time Service Mode (Time Service)

2.2.4 Operator/Manager Features

Description

This PBX supports one operator and one manager. Any extension can be designated as the operator through system programming (→ Operator Assignment [008]). The operator is the destination of Operator Call. The extension connected to extension jack 01 is the manager extension. An extension assigned as the operator or manager extension is allowed to use certain features that most extensions cannot, as follows:

Feature		Description	Manager Password*	Details in
Manager Programming	System Speed Dialling Number [001]	Sets the System Speed Dialling number.	Required	• 1.6.1.5 Speed Dialling—Personal/System
	System Speed Dialling Name [011]	Sets the System Speed Dialling name.	Required	• 1.6.1.5 Speed Dialling—Personal/System
	DISA Security Code [512]	Sets the DISA security code.	Required	• 1.15.6 Direct Inward System Access (DISA)
	DISA Security Code Digits [530]	Sets the number of digits for the DISA security code.	Required	• 1.15.6 Direct Inward System Access (DISA)
	Call Log Printout for Each Extension	Prints and clears call logs for each extension.	Required	• 1.20.1.2 Call Log Printout for Each Extension
	Call Charge Management	Sets, displays, clears, and prints the call charge data.	Required	• 1.20.2 Call Charge Calculation
	Extension Password Set	Sets the extension password. This password is used for the Walking COS feature and the Remote Extension Lock feature. Each extension's password should be unique.	Required	–
Remote Extension Lock		Sets or cancels Extension Lock on an extension remotely.	Not required	• 1.8.4 Extension Lock
Time Service		Switches the time service mode manually.	Not required	• 2.2.3 Time Service
Remote Timed Reminder (Wake-up Call)		Sets or cancels Timed Reminder to any extension remotely.	Not required	• 1.21.2 Timed Reminder
Incoming Call Log in the Common Area—CLEAR ALL		Clears all Caller ID information stored in the common area.	Not required	• 1.16.2 Incoming Call Log

Feature	Description	Manager Password*	Details in
Incoming Call Log Display Lock in the Common Area	Locks or unlocks the Incoming Call Log for the common area.	Not required	<ul style="list-style-type: none"> • 1.8.4 Extension Lock • 1.16.2 Incoming Call Log
301st Incoming Call Logged in the Common Area	Selects how new calls are treated when Incoming Call Log for the common area is full.	Not required	<ul style="list-style-type: none"> • 1.16.2 Incoming Call Log
Outgoing Message (OGM) for DISA/UCD	Records and plays back OGMs used by DISA, Uniform Call Distribution (UCD), and 3-level Automated Attendant (AA). Erases OGMs used by DISA and UCD.	Not required	<ul style="list-style-type: none"> • 1.15.5 Outgoing Message (OGM) for DISA/UCD
Date and Time Setting	Adjusts the current date and time.	Not required	–
Extension Lock—CANCEL ALL	Cancels Extension Lock, Incoming Call Log Display Lock in the Personal Area, and Message Waiting for Another Extension Lock at all extensions.	Not required	<ul style="list-style-type: none"> • 1.8.4 Extension Lock • 1.16.2 Incoming Call Log • 1.17.1 Message Waiting
LCS Password Control	Clears the Live Call Screening (LCS) password.	Not required	<ul style="list-style-type: none"> • 1.19.1 Voice Mail APT Integration
Common BV OGM	Records, plays back, and erases a common BV OGM in the common message area that can be accessed by either the operator or manager.	Not required	<ul style="list-style-type: none"> • 1.15.7 Built-in Voice Message (BV)

* The system password may be entered instead of the extension password for the manager (manager password).

Operator Call

An extension user can call the operator by entering the Operator Call number (→ Automatic Line Access [121]), often simply, "0". If no operator is assigned, the caller will hear a reorder tone. If the Automatic Line Access number is assigned to "0" through system programming, the Operator Call number will be changed to "9".

Note

For New Zealand, the Automatic Line Access number may be either 1 or 9.

User Manual References

- 1.2.1 Basic Calling
- 2.1 Control Features
- 3.2.2 Managing Call Logs and Call Charges

2.3 System Data Control

2.3.1 PC Programming

Description

System programming settings can be accessed using a PC and the Panasonic KX-TE Maintenance Console software as well as by using a proprietary telephone (PT) (→ 2.3.2 PT Programming). System programming and data upload/download can be performed either through on-site programming or remote programming.

1. **On-site Programming:** Programming that is performed using an on-site PC connected directly to the PBX.
2. **Remote Programming:** Programming that is performed using an off-site PC that connects to the PBX via an outside (CO) line.

1. Connection Methods for On-site Programming

Method	Description	Required Hardware
Serial Interface (RS-232C)	The PC is connected to the PBX via the Serial Interface (RS-232C) port of the PBX.	—
USB	The PC is connected to the PBX via the USB port of the PBX.	—

2. Connection Methods for Remote Programming

Method	Description	Required Hardware
Remote modem	<p>Call the PBX and have the call directed to the internal modem using one of the following methods:</p> <p>Direct Access: Using a modem, dial the telephone number to connect to the internal modem. To use this feature, "MODEM" must be selected as the distribution method for the desired outside (CO) line port (→ CO Line Mode—Day/Night/Lunch [414-416]).</p> <p>DISA: Using a telephone, dial the telephone number to reach the DISA line (→ 1.15.6 Direct Inward System Access (DISA)). After hearing a DISA outgoing message (OGM), enter the Remote Maintenance feature number to access the internal modem. To use this feature, "DISA" must be selected as the distribution method for the desired outside (CO) line port (→ CO Line Mode—Day/Night/Lunch [414-416]).</p> <p>Call Transfer: Using a telephone, call an extension user, such as the operator, to request to be transferred to the internal modem using the Remote Maintenance feature number (→ 1.11.1 Call Transfer).</p>	User-supplied modem

Conditions

- Only one system programming session is permitted at a time. Access will be denied to a second party who tries to perform system programming, including system programming via a PT.
- System programming can be performed either in interactive or batch mode.
- **System Password**
To access system programming in interactive mode, a valid password must be entered. The password is set at the factory but can be changed through system programming (→ System Password [002]).
- A user can upload system programming data from a PC to the PBX or download it from the PBX to a PC.
- If communications between the PBX and PC fail before completing Firmware Upgrade or system programming data upload from a PC to the PBX, the successfully transferred portion of the data can still be used.
- Firmware Upgrade can be performed only through on-site programming using the Serial Interface (RS-232C) port or USB port.

Installation Manual References

3.2.1 Connection

3.2.3 Accessing PBX via Internal Modem

Feature Guide References

1.1.1.1 Direct In Line (DIL)

3.2 PC Programming

2.3.2 PT Programming

Description

A proprietary telephone (PT) can be used to customise the settings of the PBX or of an extension, using the following programming features:

Programming Type	Description	Example	Authorised Programmer
Personal Programming	Used by an extension user to customise the extension's settings.	One-touch Dialling, Line Preference—Outgoing, etc.	Extension user
System Programming	Used by an authorised party to customise the PBX.	System Password, Extension Number, etc.	Authorised administrator
Manager Programming	Used by the manager to customise 4 system programming settings of the PBX, set a password to each extension, print out call log information for each extension, and programme call charges.	System Speed Dialling Number, Extension Password Set, Call Log Printout for Each Extension, Call Charge Management etc.	Manager

Conditions

- The manager extension is the extension that is connected to the lowest-numbered jack (jack 01) of the PBX and can therefore perform manager programming.
- Only one system programming (including PC programming) or manager programming session is permitted at a time. These 2 programming features cannot be performed simultaneously by 2 users.
- During programming, the PT is considered to be busy and will not receive calls.
- **System Password**
To access system programming, the administrator system password must be entered. The system password is set at the factory but can be changed through system programming (→ System Password [002]). The administrator can programme all system programming.
- **Manager Password**
To set the manager password, it is necessary to use the system password to perform Extension Password Set. Once set, the manager password can be used to access manager programming. The manager can assign a password to each extension (extension password).
- **Personal Programming Data Reset**
A PT user can simultaneously reset all settings made through personal programming (Line Preference—Incoming/Outgoing, Call Waiting Tone Type Selection, etc.) to their default settings. This feature also cancels pressing the AUTO ANS/MUTE button in the Hands-free Answerback feature and the Room Monitor feature.
- **System Programming Data Reset**
The PBX can return all or specific settings made through system programming to their default settings based on the following parameters (→ System Data Clear [999]):
 - All para:** All data
 - System para:** All data except for "CO para", "Extn. para", and "DSS para"
 - CO para:** The data assigned for each outside (CO) line
 - Extn. para:** The data assigned for each extension

- e) **DSS para:** The data assigned on the Direct Station Selection (DSS) buttons and Programmable Feature (PF) buttons on the DSS Console
- f) **Speed dial:** The System Speed Dialling numbers and names in System Speed Dialling Number [001] and System Speed Dialling Name [011]

Installation Manual References

2.10.1 Starting the Advanced Hybrid System

Feature Guide References

2.2.4 Operator/Manager Features

3.3 PT Programming

User Manual References

3.1 Customising Your Phone (Personal Programming)

3.2 Managing Call Logs and Call Charges

3.3 Customising Your PBX (System Programming)

2.3.3 Automatic Time Adjustment

Description

The PBX clock can be adjusted automatically according to the time information received from your telephone company. Time information can be received when an incoming call with Caller ID that includes time information is received.

The PBX clock will be adjusted every day with the first call after 3:05 A.M., if enabled through system programming (→ Automatic Time Adjustment [152]).

Note

Since the PBX clock is put ahead by one hour on the Summer Time start date, a timed reminder set within one hour of the Automatic Time Adjustment feature will not ring.

Since the PBX clock is put back by one hour on the Summer Time end date, a timed reminder set within one hour before the Automatic Time Adjustment feature will ring 2 times.

Conditions

- SMDR will log call information using the PBX clock so that the logging time will be overlapped at the end of Summer Time (→ 1.20.1 Station Message Detail Recording Feature).

Feature Guide References

1.21.2 Timed Reminder

2.3.4 Feature Numbering

Description

To call another extension user or to access PBX features, access numbers (extension numbers or feature numbers) are required.

Feature numbers are available while:

1. a dial tone is heard
2. a busy tone or Do Not Disturb (DND) tone is heard
3. dialling or talking
4. on-hook

1. Feature Numbering (available while a dial tone is heard)

Extension numbers and features that are available while a dial tone is heard have fixed numbers and flexible numbers respectively, shown in the following table:

a) Extension Numbers:

The extension numbering plan can be selected through system programming (→ Extension Number [009]).

When the extension numbering plan is selected, the default extension numbers change automatically as follows*:

Plan 1/Plan 2: extension jacks 01 through 24—extension numbers 101 through 124

Plan 3: extension jacks 01 through 24—extension numbers 11 through 34

If a rotary single line telephone (SLT) is used at any extension, select "Plan 1".

Note

* For United Kingdom and New Zealand, when the extension numbering plan is selected, the default extension numbers change automatically as follows:

Plan 1/Plan 2: extension jacks 01 through 24—extension numbers 201 through 224

Plan 3: extension jacks 01 through 24—extension numbers 21 through 44

b) Feature Numbers:

When "Plan 2" or "Plan 3" is selected, feature numbers starting with "7" are useable with and without "#" added before "7".

[Example]

The default feature number for setting "Do Not Disturb (DND)" is "714#". "714#" and "#714#" are both available for "Plan 2" and "Plan 3".

To make them easier to remember, it may be helpful to replace the new feature numbers for "Plan 2" and "Plan 3" with the code numbers 50 through 59, through system programming (→ Second Feature Numbering Plan [012]).

2.3 System Data Control

[Feature Numbering Table (available while a dial tone is heard)]

Feature	Numbering			Additional Number
	Plan 1	Plan 2	Plan 3	
Absent Message (set/cancel)	75			(1–6 [+ parameter]/0) + #/0
Account Code Entry for an SLT	** or 49	**		account code + outside phone no.
Automatic Line Access (Local Access)* ¹	9/0			outside phone no.
Built-in Voice Message (BV) (record/play/erase)	725			([1 + extn. no.]/2/0) + #/0
Call Forwarding (FWD)—All Calls, Busy/No Answer (set/cancel)	71			([1 or 2 + extn. no.]/0) + #/0
Call Hold (Hold Mode 2 or 3) for an SLT* ²	20	#20		
Call Hold Retrieve for outside (CO) line calls/intercom calls	53/5	#59/#5		outside (CO) line no. (1–8)/extn. no.
Call Park/Call Park Retrieve* ³	22/52	#22/#56		0–9
Call Pickup Deny (set/cancel)	72			(1/0) + #/0
Call Waiting for intercom calls/doorphone calls (set/cancel)	732			(1/0) + #/0
Call Waiting for outside (CO) line calls (set/cancel)	731			(1/0) + #/0
Common BV Outgoing Message (OGM) (record/play/erase)	722			01–24 + (1/2/0) + #/0
Conference (5-party)	22*	#22*		(phone no. + CONF) 4 times + CONF
Data Line Security (set/cancel)	730			(1/0) + #/0
Directed Call Pickup	4	#41		extn. no.
Do Not Disturb (DND) (set/cancel)	71			(4/0) + #/0
Doorphone Call/Door Open	31/55	#31/#55		1–4* ⁴
Executive Busy Override Deny (set/cancel)	733			(0/1) + #/0
Extension Lock (set/cancel)	77			0000–9999 (2 times/one time) + #/0
Extension Number* ⁵	100–199	100–499	10–49	
External Feature Access (EFA) for an SLT	6			
Extension Feature Clear	79			#/0
FWD—Follow Me (set/cancel)	71			(5/8) + extn. no. + #/0
FWD to BV (set/cancel)	71			([1 or 2 + 725]/0) + #/0

Feature	Numbering			Additional Number
	Plan 1	Plan 2	Plan 3	
FWD to Outside (CO) Line (set/cancel)	71			(3 + outside (CO) line access no. + outside phone no. + #)/(0 + #/0)
FWD to Voice Processing System (VPS) (set/cancel)	71			([1 or 2 + extn. no.]/0) + #/0
Group Call Pickup	40	#40		
Hot Line for an SLT (programme)	74			2 + phone no. + #
Hot Line for an SLT (set/cancel)	74			(1/0) + #/0
Incoming Call Log in the Personal Area—CLEAR ALL	70*			#
Incoming Call Log in the Common Area—CLEAR ALL	70**			#
Last Number Redial for an SLT	## or 80	### or 80		
Live Call Screening (LCS) Password (set/cancel)	77*			000–999 (2 times/one time) + #
Log-in/Log-out	736			(0/1) + #/0
Logging of Caller ID Information in the Common Area (set/cancel)	738			(2/0) + #/0
Logging of Caller ID Information in the Personal Area (set/cancel)	738			(1/0) + #/0
Message Waiting (leave/cancel for a caller)	70			(1/2) + extn. no. + #/0
Message Waiting (cancel all for a called extension)	70			0 + #/0
Message Waiting (cancel all for another extension)	70			3 + extn. no. + #
Message Waiting Answer	784			#/0
Message Waiting for Another Extension Lock (set/cancel)	70			4000–9999 (2 times/one time) + #/0
Operator Call	0/9			
Outside (CO) Line Group Access	8			1–8 + outside phone no.
Paging—All Extensions & External	33	#33		* or 9
Paging—All Extensions/Group	33	#33		0/1–8
Paging—External	34	#34		
Paging Answer	43	#43		
Paging Deny (set/cancel)	734			(1/0) + #

2.3 System Data Control

Feature	Numbering			Additional Number
	Plan 1	Plan 2	Plan 3	
Personal BV OGM (record/play/erase)	723			(1/2/0) + #/0
Personal Speed Dialling (confirm)	3*			0–9 + #
Personal Speed Dialling (dial)	1* or #	1* or ##		0–9
Personal Speed Dialling (programme)	2*			0–9 + phone no. + #
Remote Maintenance	729			
Remote Timed Reminder (set/cancel/confirm)	764			extn. no. + # + 76 + ([hhmm + parameter]*6/2/3) + #
Room Monitor (set/cancel)	735			(1/0) + #
Room Monitor through a doorphone	31	#31		1–4*4
System Speed Dialling for an SLT (dial)	*			00–99
Timed Reminder (set/cancel)	76			([hhmm + parameter]*6/2) + #/0
Timed Reminder (confirm)	76			3 + #
Time Service (set/cancel)	78			([1–3]/0) + #
Walking COS	7*			extn. password + the user's extn. no. + #/0
21st Incoming Call Logged in the Personal Area (disregard the newest call/overwrite the oldest call)	737			(0/1) + #
301st Incoming Call Logged in the Common Area (disregard the newest call/overwrite the oldest call)	737			(2/3) + #

*1 For New Zealand: 1 or 9

*2 For United Kingdom/New Zealand: Plan 1: 50; Plan 2/Plan 3: #50

*3 For United Kingdom/New Zealand: Plan 1: 36/56; Plan 2/Plan 3: #36/#56

*4 When using an optional 2-port doorphone card, select "1" and/or "3" (not "1" and/or "2") as the doorphone/door opener number.

*5 For United Kingdom/New Zealand: Plan 1: 200–299; for New Zealand: Plan 2: 200–499, Plan 3: 20–49

*6 hh: hour (01–12), mm: minute (00–59), AM/PM (0/1), one time/daily (1/2)

2. Feature Numbering (available while a busy tone or DND tone is heard)

Features that are available while a busy tone or DND tone is heard have fixed numbers, as shown in the following table:

[Feature Numbering Table (available while a busy tone or DND tone is heard)]

Feature	Numbering
Automatic Callback Busy	6
Busy Station Signalling (BSS)/DND Override	2
Executive Busy Override	3

3. Feature Numbering (available while dialling or talking)

Features that are available while dialling or talking have fixed numbers, as shown in the following table:

[Feature Numbering Table (available while dialling or talking)]

Feature	Numbering
Alternate Calling—Ring/Voice	✖
Call Retrieving from a Telephone Answering Machine (TAM)	4*1
Conference (3-party) for an SLT	3*2
Door Open	5
Pulse to Tone Conversion*3	✖#

*1 Dial after dialling the TAM's extension number and hearing its busy tone.

*2 Plan 1: 3; Plan 2/Plan 3: #3

*3 This feature is not available for the AL (Australia) model.

4. Feature Numbering (available while on-hook)

Features that are available while on-hook have fixed numbers, as shown in the following table:

[Feature Numbering Table (available while on-hook)]

Feature	Numbering
Background Music (BGM) set/cancel	1
Time Service mode display	#
Extension number and extension name display/ date (month [day]/day [month]) and time display/ date (month [day]/day [month]/year/day of the week) display changing	✖

Conditions

- If a feature number includes "✖" or "#", except for those that can use "0" instead of "#", rotary SLT users cannot use it.
- **Feature number + Additional number (Parameter)**
Certain feature numbers require additional digits to make the feature active. For example, to set Call Waiting, the feature number for "Call Waiting" must be followed by "1" and to cancel it, the same feature number should be followed by "0".

User Manual References

4.2.1 Feature Number Table

2.3.5 Automatic Configuration for Outside (CO) Line Type

Description

The dialling mode (DTMF [Dual Tone Multi-Frequency]/Pulse) of connected outside (CO) lines is automatically assigned after restarting the PBX using the System Clear Switch or through system programming (→ System Data Clear [999]). No system programming in Dial Mode [401] and Pulse Speed [402] is required unless the dialling mode of the connected outside (CO) line is Call Blocking. Automatic Configuration for Outside (CO) Line Type can also be programmed the first time the PBX is accessed with a PC using the KX-TE Maintenance Console software (Quick Setup). For more information about Quick Setup, refer to the Installation Manual (→ 3.1.1 Installing KX-TE Maintenance Console on a PC).

Conditions

- If no outside (CO) lines are connected to the outside (CO) line ports of the PBX, the default values are assigned automatically.
- It takes a maximum of 4 minutes to complete checking the dialling mode, unless the outside (CO) line is in use. In this case, the PBX will start checking it after the outside (CO) line becomes idle.
- This feature will not function properly when:
 - It takes 3 seconds or more to detect the dialling mode of your telephone company.
 - The cable from the outside (CO) line is disconnected while the PBX is checking the dialling mode.
- If your telephone company or a host PBX can receive both DTMF and Pulse signals, the PBX selects an outside (CO) line type according to the following priority:
DTMF → Pulse (High) → Pulse (Low)
- Automatic Configuration for Outside (CO) Line Type is not available for the AL (Australia) model.

Installation Manual References

4.1.5 System Reset with System Data Clear

Feature Guide References

1.5.2.4 Dial Type Selection

2.3.6 Country Setting

Description

The country code of the PBX can be selected through system programming (→ Country [995]). The PBX will restart with the default settings of the user's country/area. During this operation, communication between the PBX and PC will be disconnected one time. Country Setting can also be programmed the first time the PBX is accessed with a PC using the KX-TE Maintenance Console software (Quick Setup). For more information about Quick Setup, refer to the Installation Manual (→ 3.2.2 Starting KX-TE Maintenance Console for the first time).

Conditions

- This feature is only available when the suffix of the connected PBX is "NE" or "CE".

2.3.7 Firmware Upgrade

Description

It is possible to upgrade the PBX software via the Serial Interface (RS-232C) port or USB port using the KX-TE Maintenance Console software. Even if a user upgrades the PBX software, the system data will not be lost. For more information on how to upgrade the PBX software, refer to the on-line help.

Conditions

- The ROM and the firmware version can be confirmed through system programming (→ Firmware Version [998]).

Installation Manual References

2.8.1 Connecting Peripherals

2.4 Fault Recovery/Diagnostics

2.4.1 Power Failure Transfer

Description

If the power supply to the PBX fails, specific single line telephones (SLTs) are automatically connected to specific outside (CO) lines (**Power Failure Connections**). The PBX will switch from the current connections to Power Failure Connections, and all existing conversations will be disconnected.

Only outside (CO) line calls handled by Power Failure Connections can be made during a power failure.

Conditions

- During a power failure, each of the following outside (CO) lines will be connected to an assigned extension.
 - Outside (CO) line 1: extension jack 01
 - Outside (CO) line 4: extension jack 09
 - Outside (CO) line 7: extension jack 17
- Only outside (CO) line calls are possible during a power failure. All other features will not function.
- We recommend connecting an SLT in parallel at extension jacks 01, 09, and 17, so that the SLT can be used during a power failure.

Note that if the paralleled SLT is on an outside (CO) line call when the power is restored, that call will be disconnected.
- Automobile-type batteries, which must be user-supplied, can be connected as a system backup power supply to operate all the features during a power failure.

The batteries can be connected directly to the unit with optional cables. For more information, refer to the Installation Manual.

Installation Manual References

- 2.2.6 Connecting Backup Batteries
- 2.9 Power Failure Connections

Feature Guide References

- 1.10.9 Paralleled Telephone

2.4.2 Power Failure Restart

Description

When the electricity is turned back on, the PBX restarts and automatically loads stored data.

Conditions

- In the event of a power failure, PBX memory is protected by a factory-installed lithium battery. There is no memory loss except the memories of Automatic Callback Busy (→ 1.7.1 Automatic Callback Busy (Camp-on)), Call Park (→ 1.12.2 Call Park), and Redial (→ 1.6.1.4 Redial).

Section 3

Programming Instructions

3.1 Introduction

3.1.1 Introduction

These programming instructions are designed to serve as an overall system programming reference for the Panasonic Advanced Hybrid System. The PBX has default settings that can be changed to meet your needs. These settings control the manner in which the PBX features described in this Feature Guide function, and changing these settings is referred to as "system programming". System programming can be performed by only one person at a time. A second person attempting to programme the system will be denied access to system programming.

Ways to Programme

There are 2 programming methods:

- **PC Programming**
PC programming is described in Section 3.2 PC Programming.
- **PT (Proprietary Telephone) Programming**
PT programming is described in Section 3.3 PT Programming. An authorised administrator or the manager can perform system programming by entering 3-digit programming numbers with a PT.

Password Security

To maintain system security, a password is required to perform system programming. When KX-TE Maintenance Console is started for the first time, the Quick Setup utility will ask you to set the system password. To avoid unauthorised access and possible fraudulent dialling, do not disclose the password.

Warning to the Administrator or Installer regarding the system password

1. Please inform the customer of the importance of the password and the possible dangers if it becomes known to others.
2. To avoid unauthorised access and possible fraudulent dialling, maintain the secrecy of the password.
3. We strongly recommend that you change the default password value to something else for reasons of system security. It is best to use a password of 7 digits.
4. Please change the password periodically.
5. If a system password is forgotten, it can be found by loading a backup of the system data into a PC, and checking the password using the KX-TE Maintenance Console software. If you do not have a backup of the system data, you must reset the PBX to its factory defaults and reprogramme it. Therefore, we strongly recommend maintaining a backup of the system data. For more information on how to back up the system data, refer to the on-line help that appears by selecting the Help menu during PC programming. However, as system passwords can be extracted from backup copies of the system data file, do not allow unauthorised access to these files.

Note

This PBX has only one system password. It can be changed by either PT programming or PC programming. For this reason, the password can consist of numerals only.

3.2 PC Programming

3.2.1 Installing and Starting KX-TE Maintenance Console

To programme and administer the PBX by PC (Personal Computer), you need to install KX-TE Maintenance Console onto the PC. To install and start KX-TE Maintenance Console when the PC and the PBX are connected, refer to the Installation Manual (→ 3.1.1 Installing KX-TE Maintenance Console on a PC). KX-TE Maintenance Console starts the programme using the drive where you installed the software automatically.

System Requirements

Required Operating System

- Microsoft® Windows® 98 SE, Windows Me, Windows 2000, or Windows XP

Minimum Hardware Requirements

- CPU: 300 MHz Intel® Celeron® microprocessor
- HDD: 100 MB of available hard disk space
- RAM: 128 MB of available RAM

3.3 PT Programming















3.3.1 Programming Instructions

Required Telephone

PBX settings can be customised through system programming by using a proprietary telephone (PT) with a display, such as the KX-T7730. An authorised administrator or the manager extension connected to extension jack 01 can access system programming.

Only one system programming session can be performed at a time; that is, only one user can access system programming at a time. This includes PC programming.

Buttons and Functions

Fixed Button (KX-T7730/KX-T7735)	Function
	PREV (PREVIOUS)
	NEXT
	
	
	
	SECRET
	STORE
	PAUSE
	PROGRAM
	END
	SELECT

Fixed Button (KX-T7730/KX-T7735)	Function
FLASH/RECALL ○	FLASH
TRANSFER ○	CLEAR

Entering System Programming Mode

Using a PT to perform system programming allows an authorised administrator to set a wide range of PBX features and parameters. To enter system programming mode, the system password is required. With the system password, all system programming is accessible.

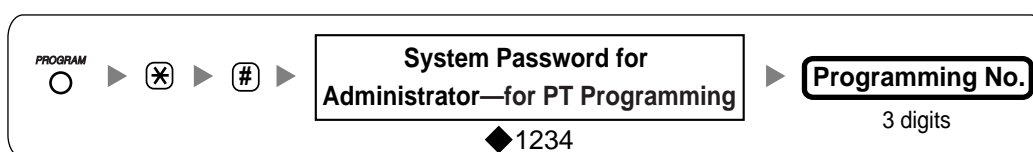

Note

◆ means default value throughout these programming instructions.

Entering Manager Programming Mode

Using a PT to perform manager programming allows the manager extension (extension jack 01) to set certain PBX features and parameters. To enter manager programming mode, the extension password for the manager (manager password) is required.

With the manager password, the following 4 system programming settings are accessible:

- System Speed Dialling Number [001]
- System Speed Dialling Name [011]
- DISA Security Code [512]
- DISA Security Code Digits [530]

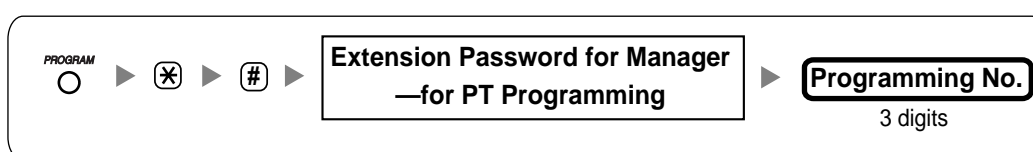

Notes

- The system password may be entered instead of the manager password.
- With the manager password, the manager can also set a password to each extension, print out call log information for each extension, and programme call charges. For more information on how to assign a password to each extension including the manager password and to print out call log information for each extension, refer to the User Manual (→ 2.1.7 Changing System Settings Using Programming Mode, 3.2.2 Managing Call Logs and Call Charges).

Entering Characters

The PT's dialling buttons can be used to enter characters when storing a name or message. The following tables depict the available characters:

Table 1 (Alphabet mode)/Table 2 (Numeral mode)

Buttons \ Times	Times								Buttons \ Times	Times
	1	2	3	4	5	6	7	8		Buttons
1	!	?	"	ç*					1	1
2	A	B	C	a	b	c			2	2
3	D	E	F	d	e	f			3	3
4	G	H	I	g	h	i			4	4
5	J	K	L	j	k	l			5	5
6	M	N	O	m	n	o			6	6
7	P	Q	R	S	p	q	r	s	7	7
8	T	U	V	t	u	v			8	8
9	W	X	Y	Z	w	x	y	z	9	9
0	(Space)	.	,	'	:	;			0	0
*	/	+	-	=	<	>			*	*
□	\$	%	&	@	()			□	□

* This character is only available with the CE (Central Europe) and PD (Poland) models, when programming Currency [921].

Table 3 (Cyrillic alphabet mode for RU [Russia]/UA [Ukraine] model)

Buttons	Times									
	1	2	3	4	5	6	7	8	9	10
1	А	Б	В	!	?	"				
2	Г	Д	Е	Ё						
3	Ж	З	И	Й						
4	К	Л	М							
5	Н	О	П							
6	Р	С	Т							
7	У	Ф	Х							
8	Ц	Ч	Ш							
9	Щ	Ъ	Ы	Ь						
0	Э	Ю	Я	(Space)	.	,	'	:	;	
*	/	+	-	=	<	>	Г*	€*	Г*	Г*
□	\$	%	&	@	()	€*	Г*	Г*	

* This character is only available for the KX-T7735RU.

[Example of Entering Characters]

To enter "Ann":

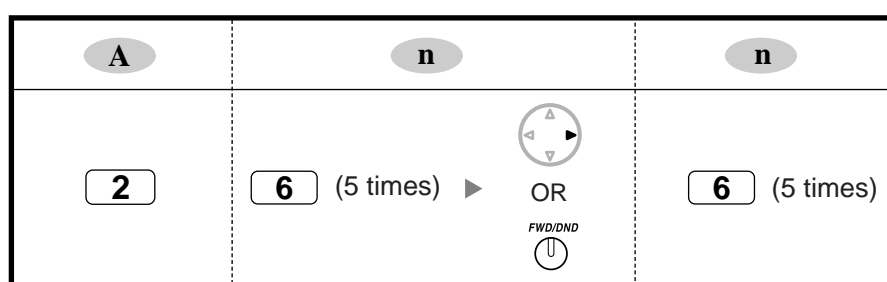

Notes

- To toggle between "Alphabet mode" and "Numeral mode" or between "Alphabet mode", "Cyrillic alphabet mode (assignable only in Extension Name in Cyrillic [616])", and "Numeral mode", press SELECT.
- To move the cursor right, press ►.
- To delete all characters, press CLEAR. To delete a character, press ◀.

List of Abbreviations

A	AA	→	Automated Attendant
	APT	→	Analogue Proprietary Telephone
	ARS	→	Automatic Route Selection
B	BGM	→	Background Music
	BV	→	Built-in Voice Message
C	CO	→	Outside (CO) Line
	COS	→	Class of Service
	CPC	→	Calling Party Control
D	DIL	→	Direct In Line
	DISA	→	Direct Inward System Access
	DND	→	Do Not Disturb
	DRD	→	Distinctive Ring Detection
	DSS	→	Direct Station Selection
	DTMF	→	Dual Tone Multi-Frequency
E	EFA	→	External Feature Access
G	GRP	→	Group
I	IRNA	→	Intercept Routing—No Answer
L	LCS	→	Live Call Screening
O	OGM	→	Outgoing Message
P	PT	→	Proprietary Telephone
S	SLT	→	Single Line Telephone
	SMDR	→	Station Message Detail Recording
	SMS	→	Short Message Service
T	TAM	→	Telephone Answering Machine
	TRS	→	Toll Restriction
U	UCD	→	Uniform Call Distribution
V	VM	→	Voice Mail

3.3.2 Programming Procedures

Notes

- ◆ means default value throughout these programming instructions.
- × means to select "All", except when setting the charge in Call Charge Calculation related programming items where it means "Decimal point".
- The following are displayed when you store a number, such as a telephone number, or feature number:
P: PAUSE; -: CONF; F: FLASH/RECALL; []: INTERCOM
x: PAUSE (substitutes for any number [i.e., wild card])
- To return to the previous programming item, press ←.
- To correct a wrong entry, press CLEAR and then enter the new input.
- To delete a stored parameter, press CLEAR, enter the new input, and then press STORE.
- Press ← or → to scroll the display.
- Some programming items cannot have a value left empty.

Date & Time [000]

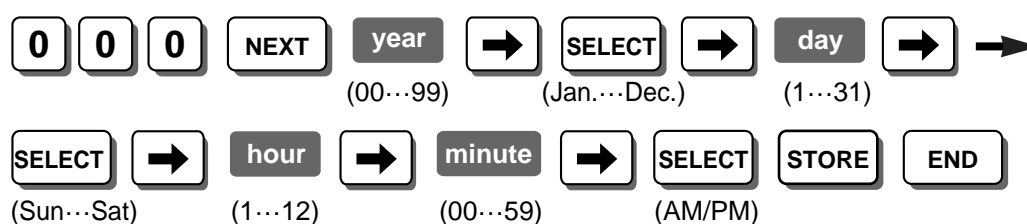

Notes

- The clock starts immediately after the STORE button is pressed.
- The PBX supports years from 2000 to 2099.

Feature & Programming References

1.20.1 Station Message Detail Recording Feature

System Speed Dialling Number [001]

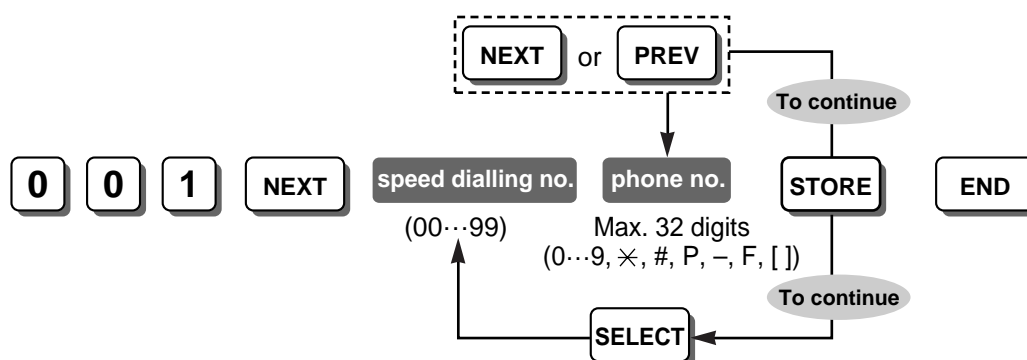

Notes

- An Outside (CO) Line Access number (9/0 [for New Zealand: 1 or 9], 81 through 88) should be included before the phone number. When dialling, a pause will automatically be inserted after the Outside (CO) Line Access number.
- When storing an account code assigned in Account Code [310], enter ** and the account code after an Outside (CO) Line Access number.

Feature & Programming References

1.6.1 Memory Dialling Features

System Password [002]

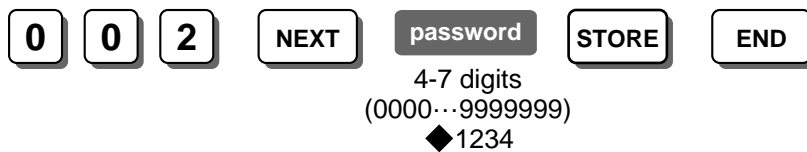

WARNING

To maintain system security, a password is required to perform system programming. To avoid unauthorised access and possible fraudulent dialling, do not disclose the password.

Warning to the Administrator regarding the system password

1. Please inform the customer of the importance of the password and the possible dangers if it becomes known to others.
2. To avoid unauthorised access and possible fraudulent dialling, maintain the secrecy of the password.
3. We strongly recommend that you change the default password value to something else for reasons of system security. It is best to use a password of 7 digits.
4. Please change the password periodically.
5. If a system password is forgotten, it can be found by loading a backup of the system data into a PC, and checking the password using the KX-TE Maintenance Console software. If you do not have a backup of the system data, you must reset the PBX to its factory defaults and reprogramme it. Therefore, we strongly recommend maintaining a backup of the system data. For more information on how to back up the system data, refer to the on-line help that appears by selecting the Help menu during PC programming. However, as system passwords can be extracted from backup copies of the system data file, do not allow unauthorised access to these files.

Note

This PBX has only one system password. It can be changed by either PT programming or PC programming. For this reason, the password can consist of numerals only.

Feature & Programming References

2.3.1 PC Programming

2.3.2 PT Programming

DSS Console Jack Assignment [003]

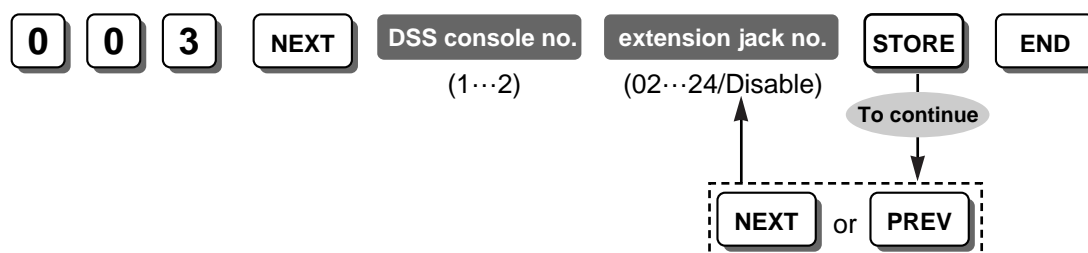

Notes

- To delete (disable) an extension jack number, press CLEAR in the extension jack number step.
- The same jack number cannot be assigned to 2 DSS Consoles.
- Do not assign extension jack 01 (manager extension) as the DSS Console jack.
- The extension jack number preassigned as a paired telephone in Console Paired Telephone [004] should not be assigned in this programme.

Feature & Programming References

1.18.1 Fixed Buttons

2.1.1 Extension Jack Configuration

Console Paired Telephone [004]

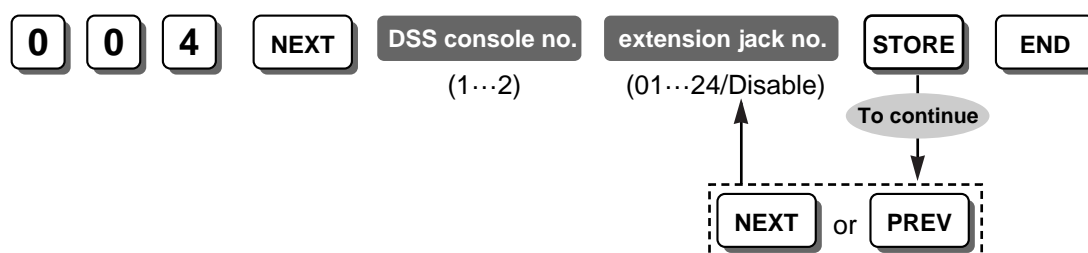

Notes

- To delete (disable) an extension jack number, press CLEAR in the extension jack number step.
- The extension jack number preassigned as a DSS Console in DSS Console Jack Assignment [003] should not be assigned in this programme.
- An SLT cannot be paired with the DSS Console.

Feature & Programming References

1.18.1 Fixed Buttons

2.1.1 Extension Jack Configuration

One-touch Transfer Using a DSS Button [005]



3.3 PT Programming

Note

With Transfer: Press the DSS button to transfer an outside (CO) line call.

Without Transfer: Press the TRANSFER button, then the DSS button to transfer an outside (CO) line call.

Feature & Programming References

1.11.1 Call Transfer

1.18.1 Fixed Buttons

Time Service Switching Mode [006]

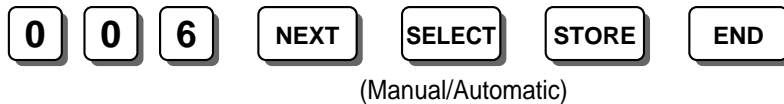

Feature & Programming References

2.2.3 Time Service

Time Service Start Time [007]

Time Service Start Time [007]

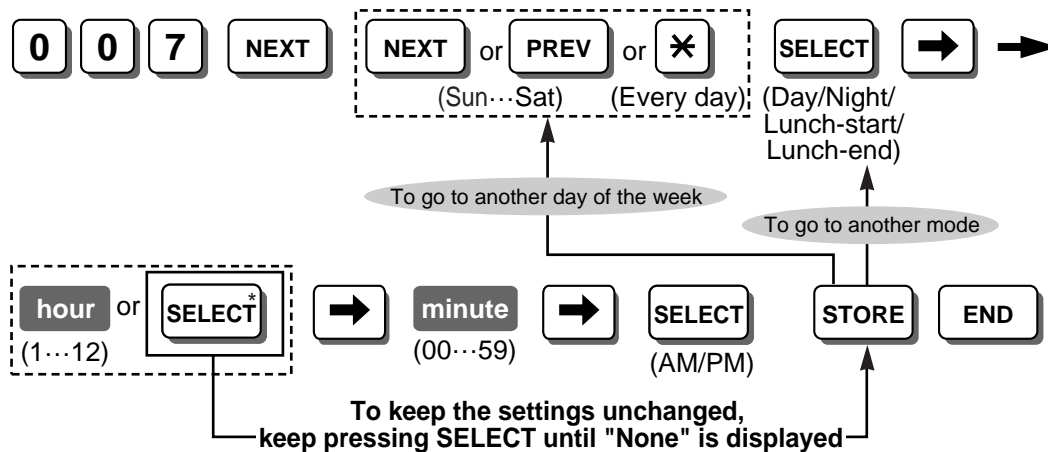

Notes

- This programme is available when switching mode is enabled in automatic mode in Time Service Switching Mode [006].
- * Pressing SELECT shows the previous entry. When the display shows "None", press SELECT to set the start time.

Feature & Programming References

2.2.3 Time Service

Operator Assignment [008]

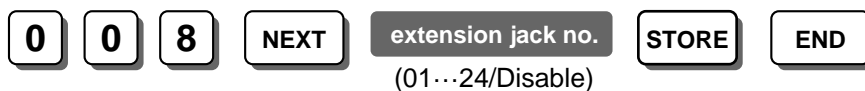

Note

To delete (disable) an extension jack number, press CLEAR in the extension jack number step.

Feature & Programming References

2.2.4 Operator/Manager Features

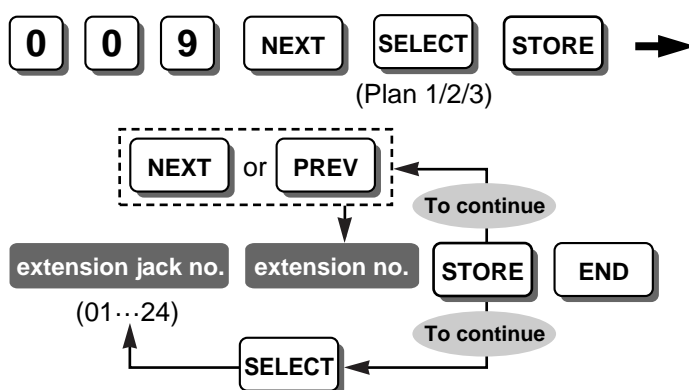
Extension Number [009]**Notes**

- Programmable extension numbers are as follows:
Plan 1: 100–199; Plan 2: 100–499; Plan 3: 10–49
(for United Kingdom/New Zealand: Plan 1: 200–299; for New Zealand: Plan 2: 200–499, Plan 3: 20–49)
- The same extension number cannot be entered for 2 different extension jacks.

Feature & Programming References

1.5.1.1 Intercom Call

1.6.1.6 Quick Dialling

1.19.2 Voice Mail Inband (DTMF) Integration

2.3.4 Feature Numbering

LCD Time Display [010]**Note**

The following settings and features use 12-hour format even if 24-hour format is assigned in this programme:

Date & Time [000]

Time Service Start Time [007]

1.20.1 Station Message Detail Recording Feature

1.21.2 Timed Reminder

System Speed Dialling Name [011]

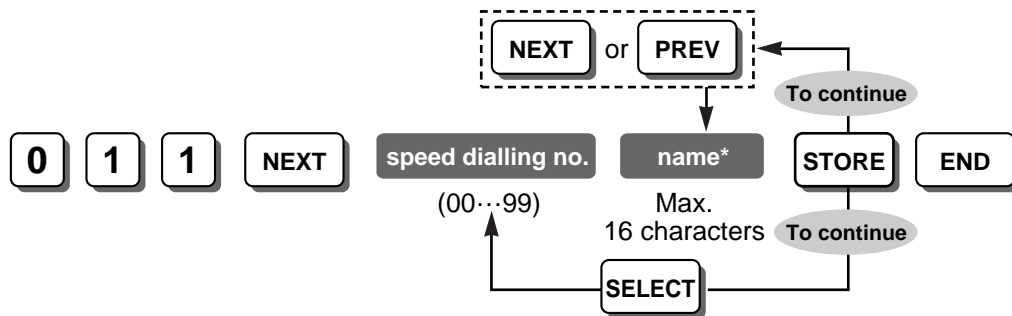

Note

* A name can be entered using a PT's dialling buttons. The displayed character varies depending on the number of times that the dialling button is pressed. It is possible to toggle between "Alphabet mode" and "Numeral mode" by pressing SELECT.

Feature & Programming References

- 1.6.1.5 Speed Dialling—Personal/System
- 3.3.1 Programming Instructions—Entering Characters

Second Feature Numbering Plan [012]

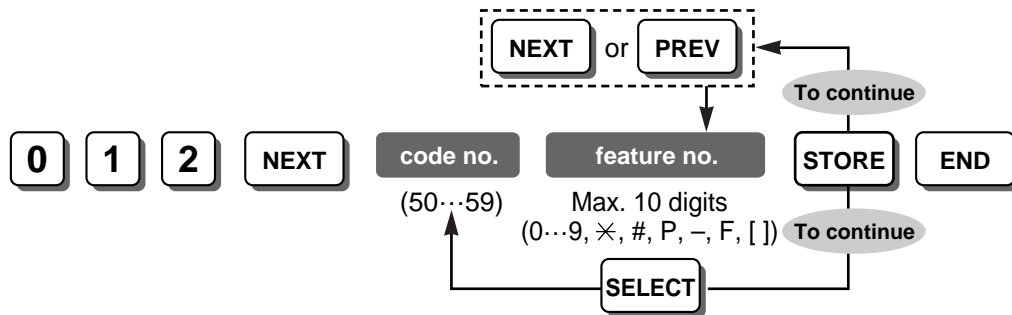

Note

This programme is available only when "Plan 2" or "Plan 3" is selected in Extension Number [009].

Feature & Programming References

- 1.6.1.6 Quick Dialling
- 2.3.4 Feature Numbering

KX-T7710 One-touch Dialling [013]

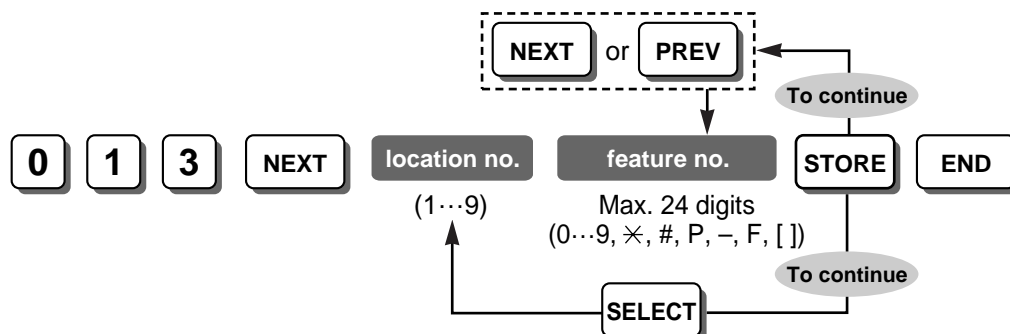

Notes

- Any feature number can be stored in a One-touch button. However, the feature numbers for Personal Speed Dialling, System Speed Dialling, and Quick Dialling do not function.
- This feature is not available when the KX-T7710 is connected in parallel with a PT.

Feature & Programming References

1.6.1.3 KX-T7710 One-touch Dialling

Hunting Group Set [100]

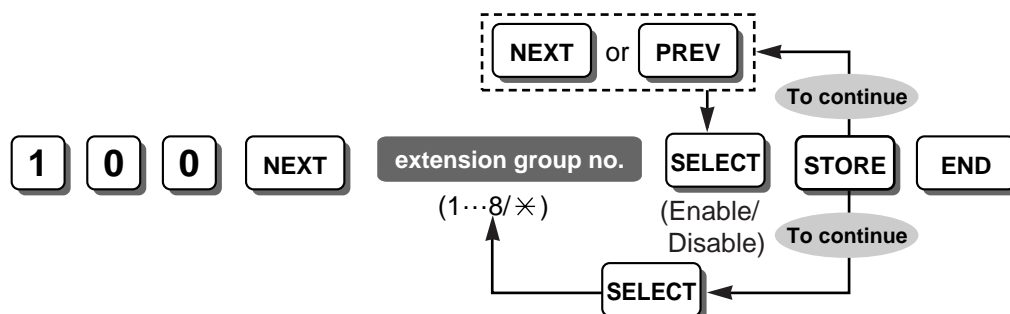

Feature & Programming References

1.2.1 Idle Extension Hunting

Extension Group [600]

Hunting Type [101]

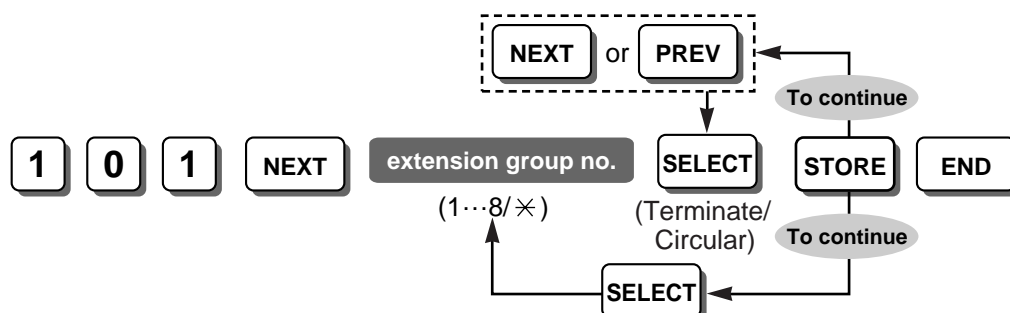

Note

This programme is available when the extension group is enabled in Hunting Group Set [100].

Feature & Programming References

1.2.1 Idle Extension Hunting

DTMF Integration Port [102]

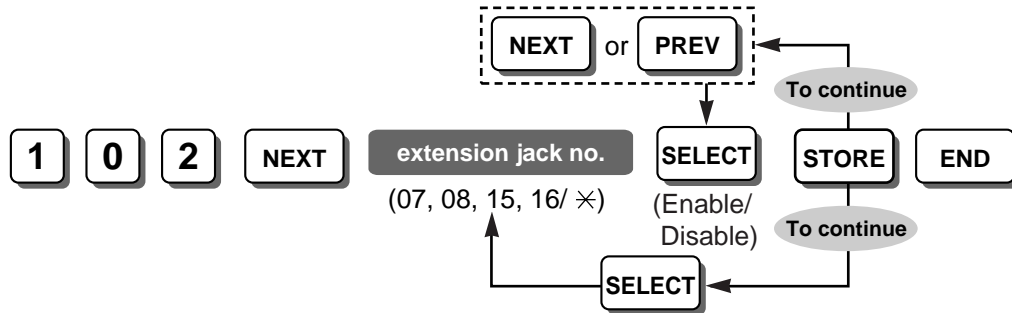

Feature & Programming References

1.19.2 Voice Mail Inband (DTMF) Integration

DTMF Integration [103]

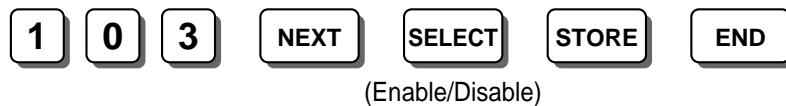

Note

When a KX-TVM/KX-TVP series VPS is connected to the PBX, to enable Inband (DTMF) Integration between the VPS and the PBX, select "Plan 1" or "Plan 2" in Extension Number [009] and "Enable" in this programme.

Feature & Programming References

1.19.2 Voice Mail Inband (DTMF) Integration

DTMF Integration Port [102]

SLT Hold Mode [104]

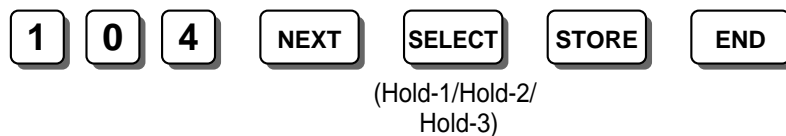

Feature & Programming References

1.12.1 Call Hold

Conference Tone [105]

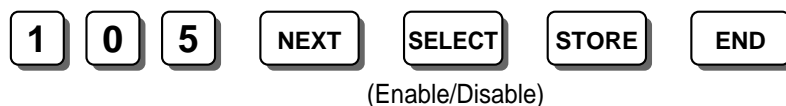

Feature & Programming References

1.7.2 Executive Busy Override

1.13.1.2 Conference

External Pager Access Tone [106]

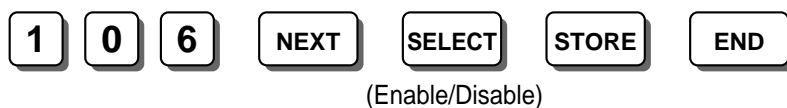

Feature & Programming References

1.14.1 Paging

DTMF Receiver Check [107]

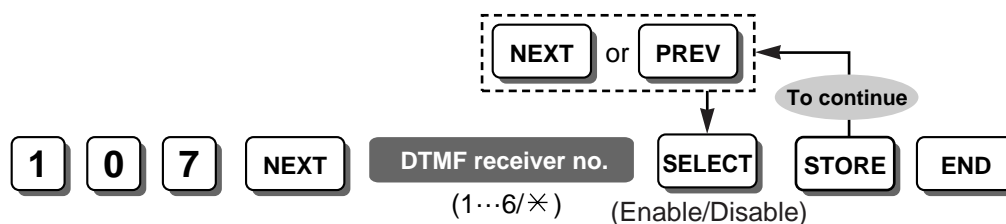

Note

This programme enables each DTMF receiver to check whether it is operating normally or not.

DTMF receiver number:

1–2: checking extension jacks 01–08

3–4: checking extension jacks 09–16

5–6: checking extension jacks 17–24

Installation Manual References

4.1.3 Operation

Flash/Recall Mode for a Locked Extension [108]

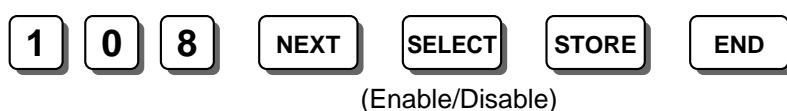

Note

This programme enables a locked extension to send a flash/recall signal during a conversation with an outside party.

CO Indicator [109]

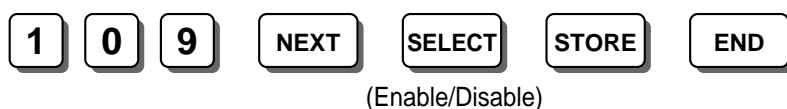

Note

This programme is available for the extension(s) assigned not to ring in Flexible Ringing—Day/Night/Lunch [408-410], to answer incoming outside (CO) line calls.

Flash/Recall Key Mode [110]



(MODE1: EFA mode/
MODE2: Flash/Recall mode)

Feature & Programming References

1.10.6 Flash/Recall

1.10.7 External Feature Access (EFA)

Music on Hold [111]



(Internal/
External/Tone)

Note

Selections vary depending on your country/area.

Feature & Programming References

1.12.4 Music on Hold

1.15.4 Background Music (BGM)

DSS Lamp Mode [112]



(Enable/Disable)

Note

Enable: FWD—Flashing slowly, DND—Flashing at moderate speed
Disable: FWD—Off, DND—Off

Feature & Programming References

1.18.3 LED Indication

Automatic Redial Repeat Count [113]



(0/3/10/
15 times)

Feature & Programming References

1.6.1.4 Redial

Automatic Redial Interval [114]

1 1 4 NEXT SELECT STORE END
(40/60 s)

Feature & Programming References

1.6.1.4 Redial

Extension Ring Tone Pattern [115]

1 1 5 NEXT SELECT STORE END
(Single/Double/
Triple)

Feature & Programming References

1.1.3.3 Ring Tone Pattern Selection

1.5.1.1 Intercom Call

4.2.1 Tones/Ring Tones

Conference Pattern [116]

1 1 6 NEXT SELECT STORE END
(3-party C-0 E-3/
3-party C-1 E-3/
3-party C-2 E-3/
5-party C-2 E-5)

Note

3-party C-0 E-3: No outside parties can attend a 3-party conference call.

3-party C-1 E-3: One outside party can attend a 3-party conference call.

3-party C-2 E-3: A maximum of 2 outside parties can attend a 3-party conference call.

5-party C-2 E-5: A maximum of 2 outside parties can attend a 3-party to 5-party conference call.

The PBX allows up to 2 outside parties to participate in a conference call. [C: CO, E: Extension]

Feature & Programming References

1.13.1.2 Conference

Call Pickup Tone [117]

1 1 7 NEXT SELECT STORE END
(Enable/Disable)

Feature & Programming References

1.4.1.3 Call Pickup

Pulse Restriction [118]

1 **1** **8** **NEXT** **SELECT** **STORE** **END**
(Enable/Disable)

Notes

- It is programmable whether pulse dialling is sent or not to the telephone company during a conversation with an outside party when "Pulse" or "Call Block" mode is enabled in Dial Mode [401].
- This programme is not available for the AL (Australia) model.

Redialling after Pulse to Tone Conversion [119]

1 **1** **9** **NEXT** **SELECT** **STORE** **END**
(Enable/Disable)

Note

This programme is not available for the AL (Australia) model.

Feature & Programming References

1.5.2.4 Dial Type Selection

Bell Frequency [120]

1 **2** **0** **NEXT** **SELECT** **STORE** **END**
(20/25 Hz)

Note

This programme selects the bell frequency sent to an SLT.

Automatic Line Access [121]

1 **2** **1** **NEXT** **SELECT** **STORE** **END**
(Dial 0/9)*

Note

* For New Zealand: 1 or 9

Feature & Programming References

1.5.3.3 Outside (CO) Line Access

2.2.4 Operator/Manager Features

Automatic Rotation for CO Line Access [122]

1 **2** **2** **NEXT** **SELECT** **STORE** **END**
(Enable/Disable)

Feature & Programming References

1.5.3.3 Outside (CO) Line Access

Break Ratio [123]



(MODE1: 66 %/
MODE2: 60 %)

Notes

- This programme selects the pulse break ratio (the ratio between the length of the pulse and the length of the pause) when a pulse is sent to the telephone company while dialling a telephone number.
- This programme is not available for the AL (Australia) model.

TRS Check for * and # [125]



(Enable/Disable)

Feature & Programming References

1.8.1 Toll Restriction (TRS)

DSS Off-hook Mode [126]



(Enable/Disable)

Feature & Programming References

1.5.1.1 Intercom Call

Pickup Group [127]

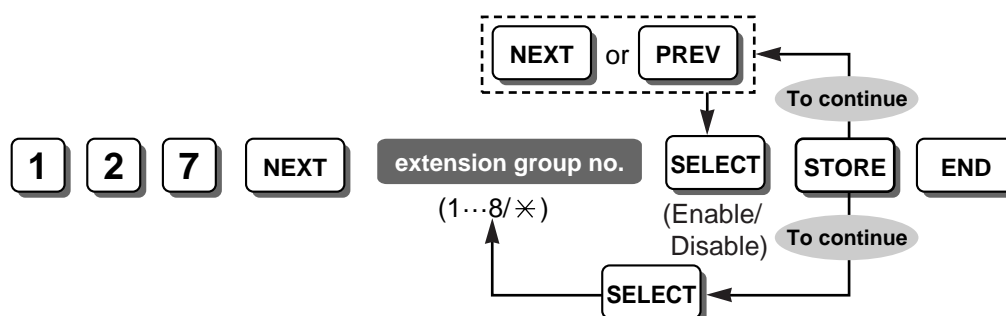

Feature & Programming References

1.4.1.3 Call Pickup

CO Indicator [109]

Ringback Tone Pattern [128]



(Single 3 s/Single 5 s/
Double 3 s/Double 5 s)

Note

This programme selects the ringback tone pattern for outgoing intercom calls and for incoming outside (CO) line calls (including a DISA call).

Feature & Programming References

1.5.1.1 Intercom Call

1.15.6 Direct Inward System Access (DISA)

4.2.1 Tones/Ring Tones

VM 1 APT Port [130]



(Port7/Port7 & 8/
Disable)

Notes

- To change the current setting (other than "Disable"), select "Disable", then select the desired setting.
- This programme is not available when "Enable" is selected in DTMF Integration [103].

Feature & Programming References

1.19.1 Voice Mail APT Integration

VM 2 APT Port [131]



(Port15/
Port15 & 16/
Disable)

Notes

- To change the current setting (other than "Disable"), select "Disable", then select the desired setting.
- This programme is not available when "Enable" is selected in DTMF Integration [103].

Feature & Programming References

1.19.1 Voice Mail APT Integration

SLT Ring/Silence Ratio [142]



Note

This programme selects the ratio between the bell signals of an SLT (a set of bell-on and bell-off).

Feature & Programming References

1.1.3.3 Ring Tone Pattern Selection

SLT Ring Bell-on Time [143]

SLT Ring Bell-on Time [143]

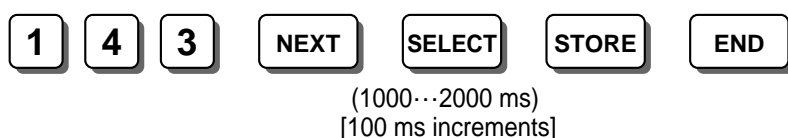

Notes

- This programme selects the length of the bell-on signal of an SLT. This determines the ring tone pattern for incoming calls to SLTs, combined with the setting in SLT Ring/Silence Ratio [142].
- This programme also determines the maximum number of digits of an SLT Caller ID number, when "DTMF1" or "DTMF2" is selected in SLT Caller ID Signalling Type [150].

Feature & Programming References

1.1.3.3 Ring Tone Pattern Selection

1.16.1 Caller ID

SMS Centre Number for Receiving [145]

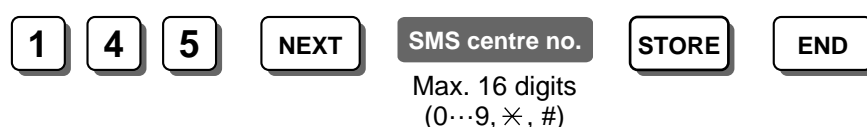

Feature & Programming References

1.17.3 Fixed Line SMS Terminal Support

SMS Routing Table—CO [146]

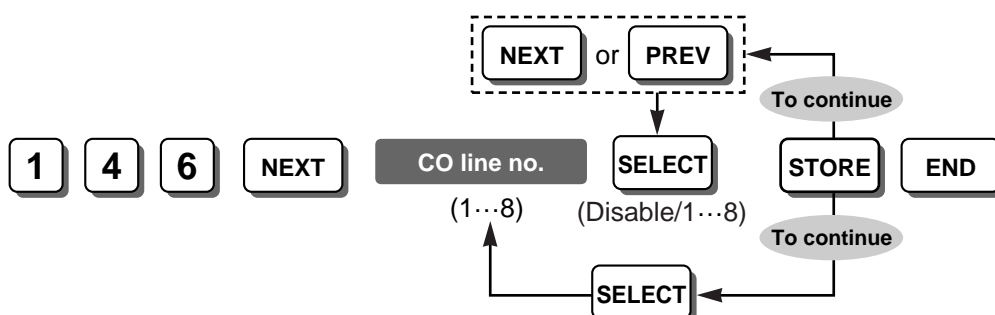

Feature & Programming References

1.17.3 Fixed Line SMS Terminal Support

SMS Routing Table—Extension [147]

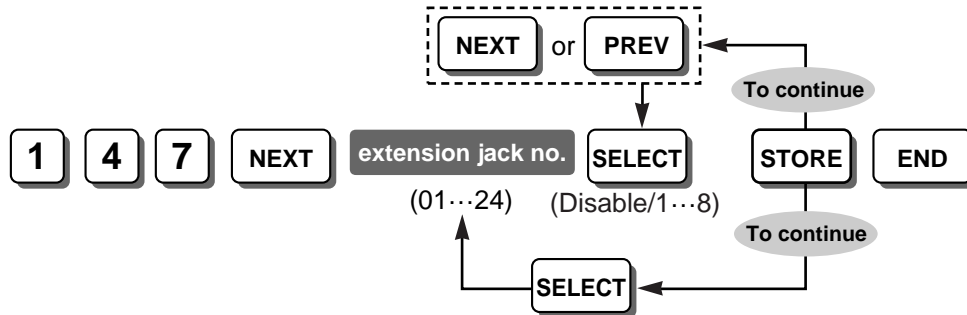

Note

Each location 1–8 has a maximum of 8 extensions.

Feature & Programming References

1.17.3 Fixed Line SMS Terminal Support

SLT Caller ID Signalling Type [150]

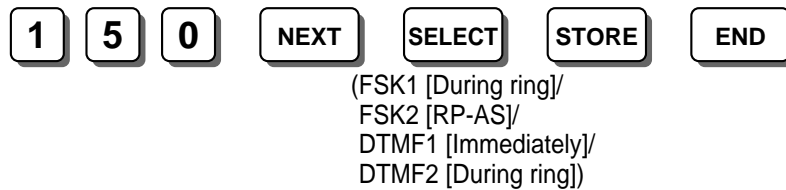

Feature & Programming References

1.16.1 Caller ID

SLT Caller ID Line Access Number [151]

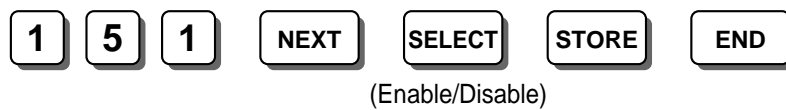

Feature & Programming References

1.16.1 Caller ID

Automatic Time Adjustment [152]

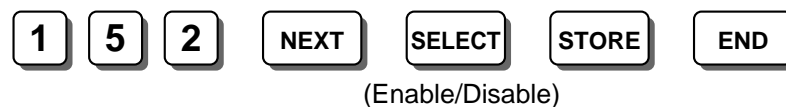

Feature & Programming References

2.3.3 Automatic Time Adjustment

Incoming Reverse [153]

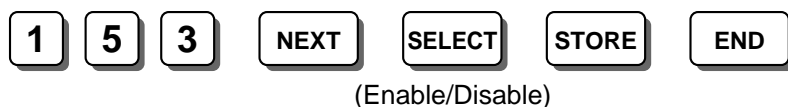

Feature & Programming References

1.10.10 Calling Party Control (CPC) Signal Detection

CO Busy Out [154]



Feature & Programming References

1.5.2.6 CO Busy Out

CO Busy Out Check Time [155]



Feature & Programming References

1.5.2.6 CO Busy Out

Call Charge Calculation—Registering Leading Numbers [161]

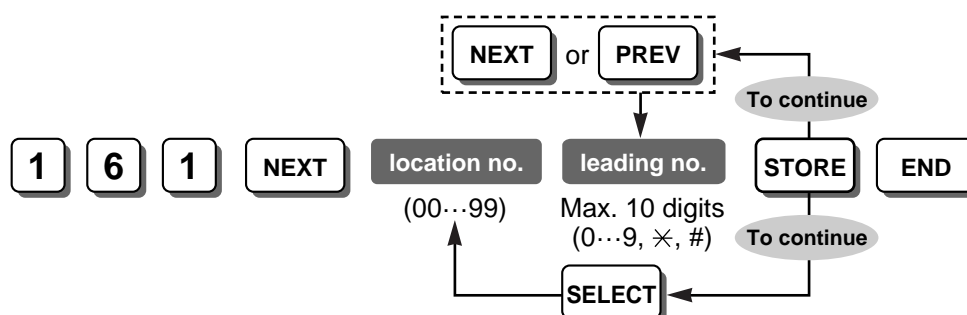

Feature & Programming References

1.20.2 Call Charge Calculation

Call Charge Calculation—Time Table 1/2/3/4 [162/169/176/183]

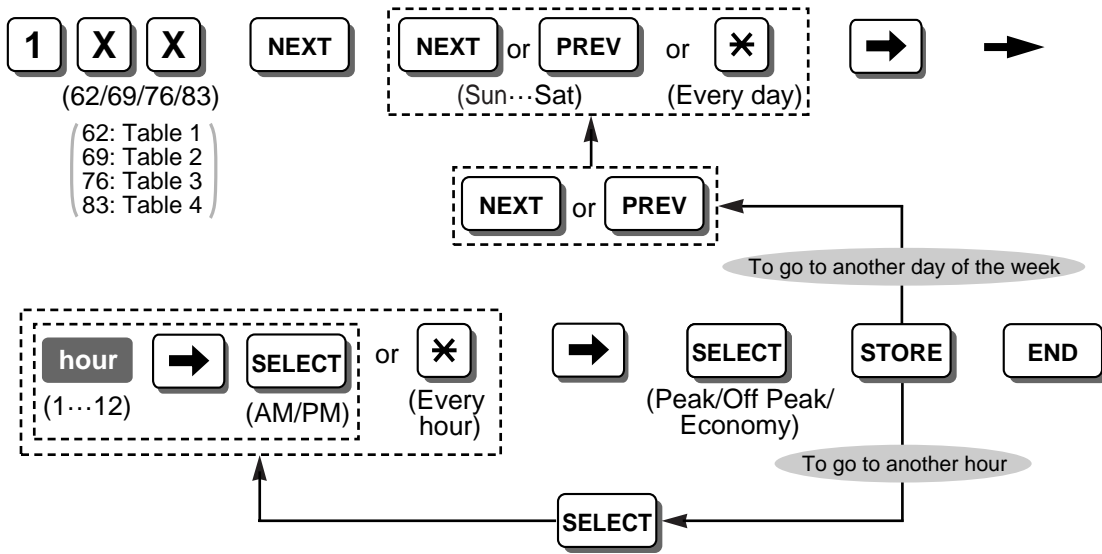

Feature & Programming References

1.20.2 Call Charge Calculation

Call Charge Table 1/2/3/4—Peak Flat Charge and Duration [163/170/177/184]

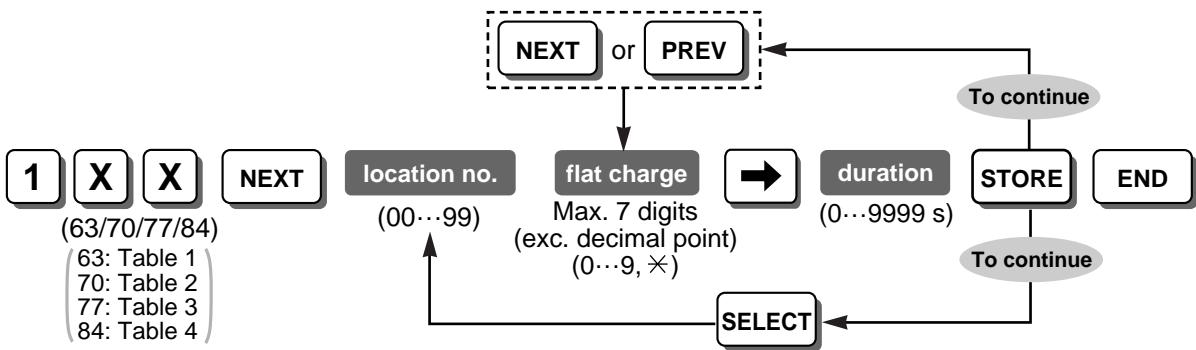

Feature & Programming References

1.20.2 Call Charge Calculation

Call Charge Table 1/2/3/4—Peak Unit Charge and Duration [164/171/178/185]

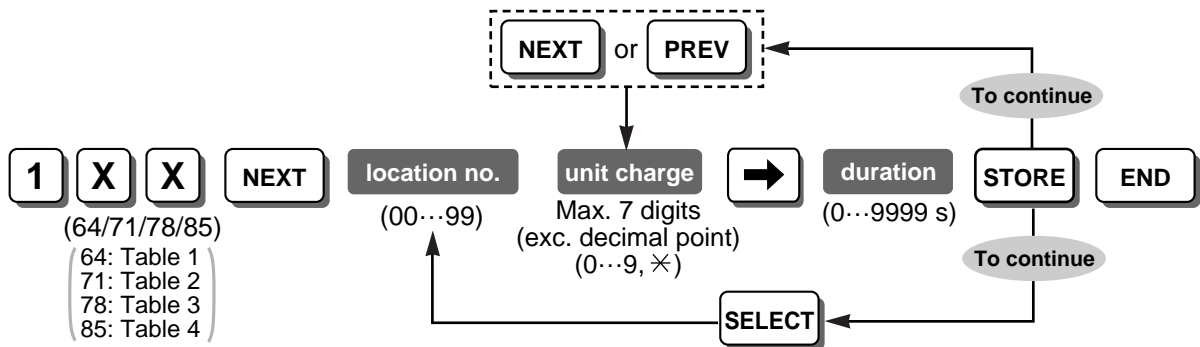

Feature & Programming References

1.20.2 Call Charge Calculation

Call Charge Table 1/2/3/4—Off Peak Flat Charge and Duration [165/172/179/186]

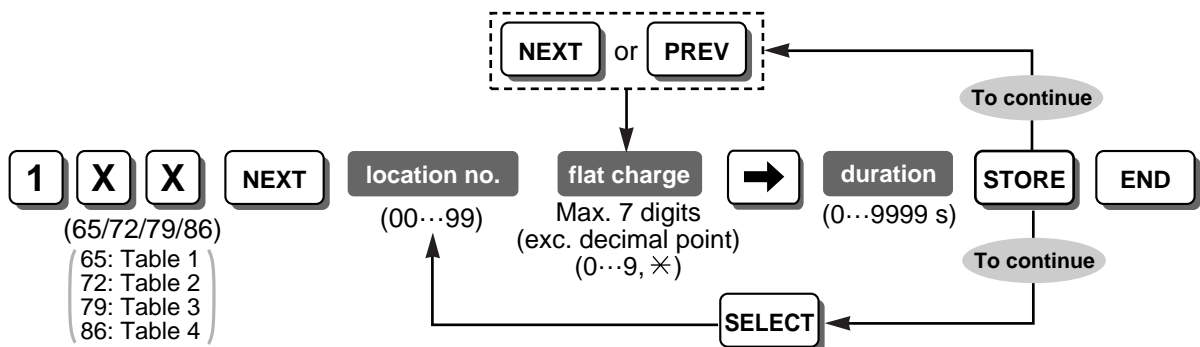

Feature & Programming References

1.20.2 Call Charge Calculation

Call Charge Table 1/2/3/4—Off Peak Unit Charge and Duration [166/173/180/187]

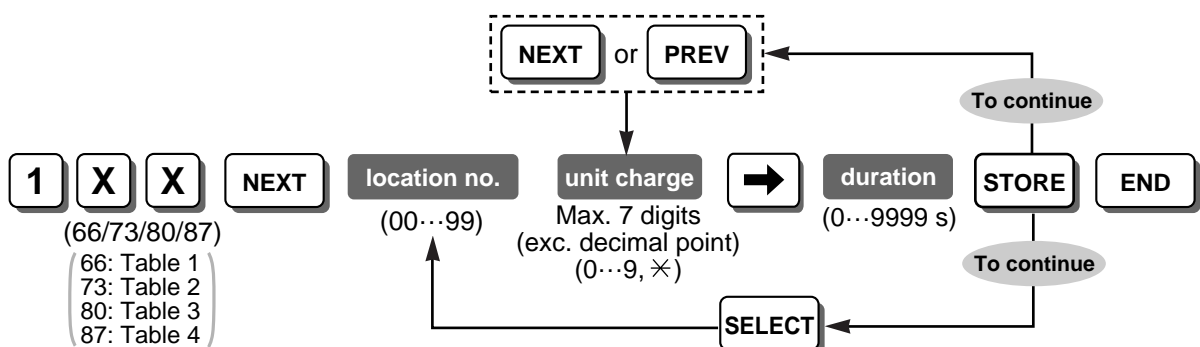

Feature & Programming References

1.20.2 Call Charge Calculation

Call Charge Table 1/2/3/4—Economy Flat Charge and Duration [167/174/181/188]

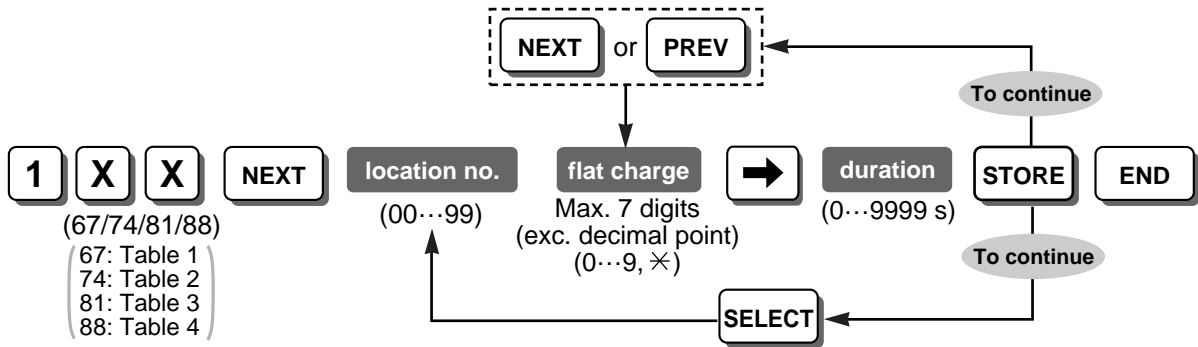

Feature & Programming References

1.20.2 Call Charge Calculation

Call Charge Table 1/2/3/4—Economy Unit Charge and Duration [168/175/182/189]

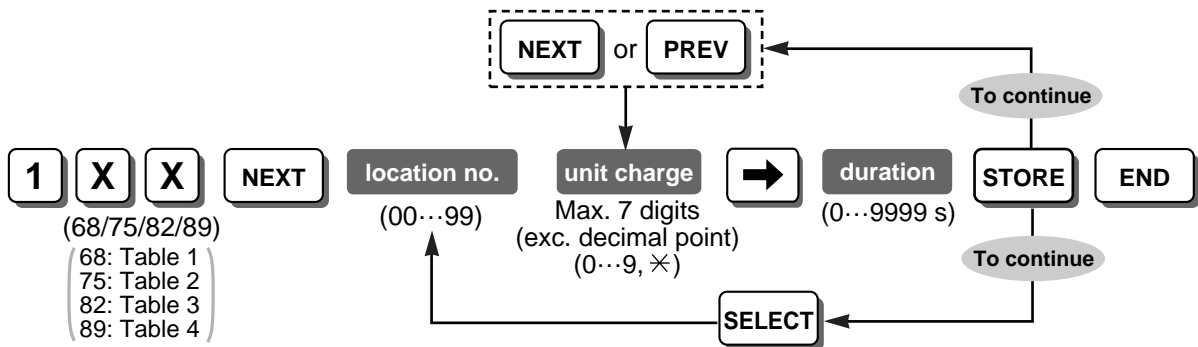

Feature & Programming References

1.20.2 Call Charge Calculation

Decimal Places [190]

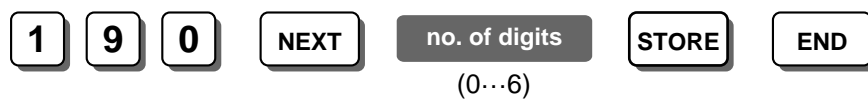

Feature & Programming References

1.20.1 Station Message Detail Recording Feature

1.20.2 Call Charge Calculation

Hold Recall Time [200]

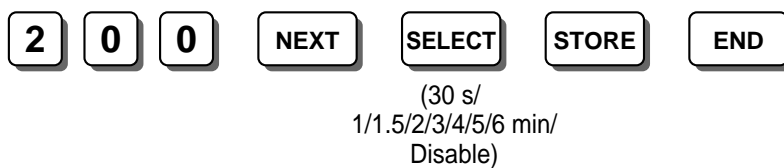

Feature & Programming References

1.12.1 Call Hold

1.12.2 Call Park

Transfer Recall Time [201]

2 0 1 NEXT SELECT STORE END

(15/30 s/
1/2 min)

Feature & Programming References

1.11.1 Call Transfer

Call Forwarding Start Time [202]

2 0 2 NEXT SELECT STORE END

(5/10/15/
20 s delay)

Feature & Programming References

1.3.1.2 Call Forwarding (FWD)

Hot Line Waiting Time [203]

2 0 3 NEXT SELECT STORE END

(0...4 s)

Feature & Programming References

1.6.1.7 Hot Line

Call Duration Counter Start [204]

2 0 4 NEXT SELECT STORE END

(5/10/15/20/25/30/35/
40/45/50 s after dialling/
Instantly)

Feature & Programming References

1.5.2.5 Reverse Circuit

1.20.1 Station Message Detail Recording Feature

Polarity Reverse Detection [424]

CO-to-CO Line Call Duration [205]

2 0 5 NEXT time STORE END

(1...32 min)

Feature & Programming References

1.10.8 Outside (CO) Line Call Limitation

Dialling Start Time [206]

2 **0** **6** **NEXT** **SELECT** **STORE** **END**

Refer to the note.*

Note

* The minimum length of time that the PBX waits after seizing an outside (CO) line before dialling that can be selected depends on your country/area as follows:

For Czech Republic: 0 ms, 250 ms, 500 ms, 750 ms, 1000 ms, 1250 ms, 3500 ms

For Others: 0 ms, 250 ms, 500 ms, 750 ms, 1000 ms, 1250 ms, 1500 ms

Feature & Programming References

1.5.3.3 Outside (CO) Line Access

Hookswitch Flash Timing Range [207]

2 **0** **7** **NEXT** **SELECT** **STORE** **END**

(MODE1: 50-180 ms/
MODE2: 80-180 ms/
MODE3: 80-650 ms/
MODE4: 80-1000 ms/
MODE5: 200-1000 ms)

Feature & Programming References

1.12.1 Call Hold

Inter-digit Time [208]

2 **0** **8** **NEXT** **SELECT** **STORE** **END**

(5/10/15/20 s)

Feature & Programming References

1.8.1 Toll Restriction (TRS)

No Dial Disconnection [211]

DTMF Time [210]

2 **1** **0** **NEXT** **SELECT** **STORE** **END**

(MODE1: 80 ms/
MODE2: 160 ms)

Note

This programme selects the minimum duration of the DTMF signal sent to outside (CO) lines that have been set to "DTMF" in Dial Mode [401].

Feature & Programming References

1.5.2.4 Dial Type Selection

No Dial Disconnection [211]

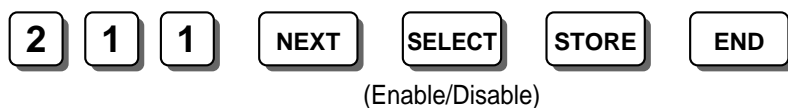

Feature & Programming References

1.8.1 Toll Restriction (TRS)

Inter-digit Time [208]

Extension-to-CO Line Call Duration [212]



Note

This programme is available for the extension(s) enabled in CO Line Call Duration Limitation [613].

Feature & Programming References

1.10.8 Outside (CO) Line Call Limitation

Bell-off Detection [213]

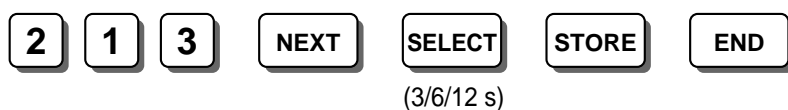

Note

This programme selects the minimum time required by the PBX to confirm that the bell signal is no longer being sent from the telephone company, before the PBX acknowledges that the call is lost.

BV Recording Time [214]



Feature & Programming References

1.15.7 Built-in Voice Message (BV)

Common/Personal BV OGM Recording Time [215]



Note

This programme selects the maximum recording time for each personal/common BV OGM.

Feature & Programming References

1.15.7 Built-in Voice Message (BV)

Carrier Exception Code [300]

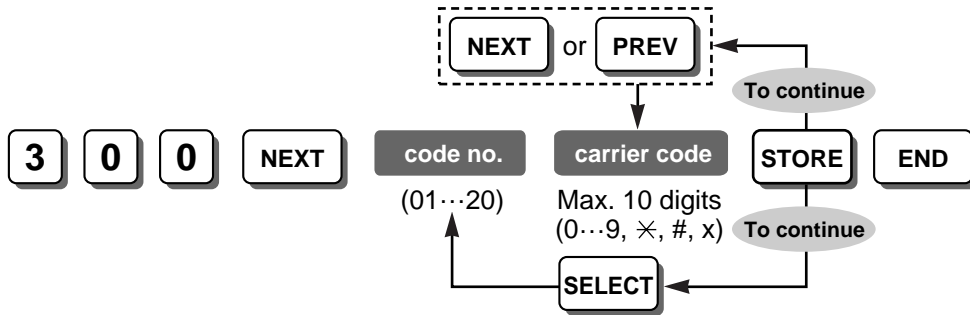

Feature & Programming References

- 1.8.1 Toll Restriction (TRS)
- 1.9.1 Automatic Route Selection (ARS)

TRS—System Speed Dialling Class [301]

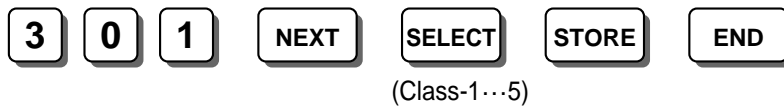

Feature & Programming References

- 1.6.1.5 Speed Dialling—Personal/System
- 1.8.1 Toll Restriction (TRS)

TRS—COS 2-5 Denied Code [302-305]

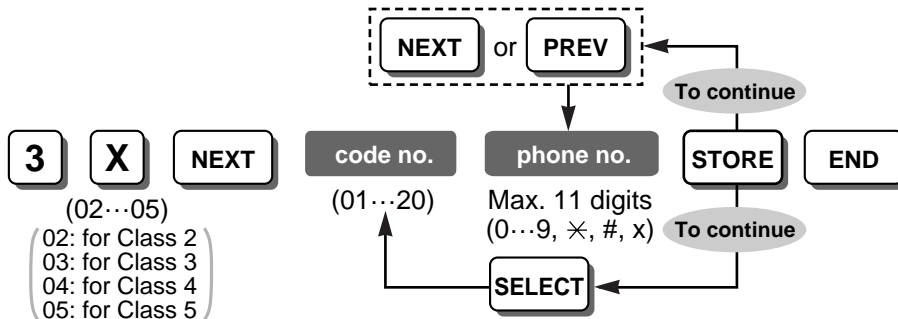

Feature & Programming References

- 1.8.1 Toll Restriction (TRS)

TRS—Exception Code [306]

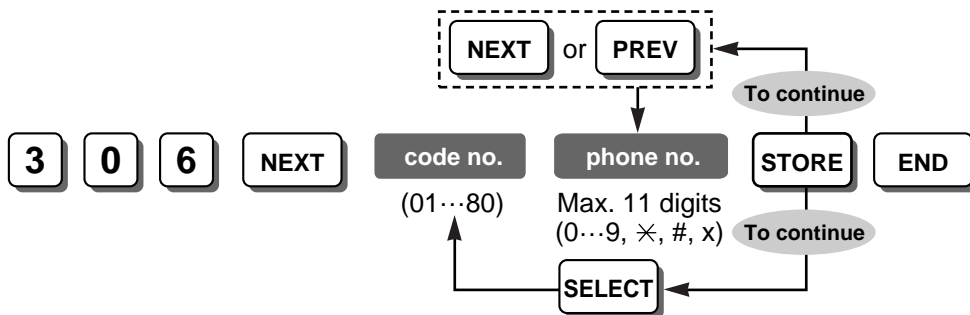

Feature & Programming References

1.8.1 Toll Restriction (TRS)

TRS—COS 2-5 Denied Code [302-305]

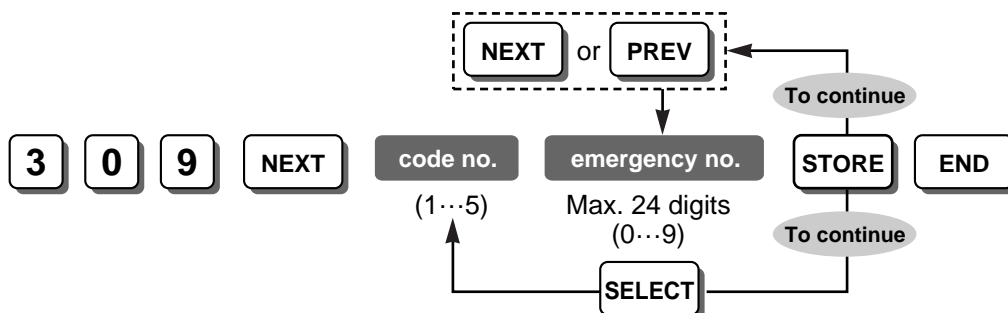
Emergency Number [309]**Feature & Programming References**

1.5.2.2 Emergency Call

1.8.1 Toll Restriction (TRS)

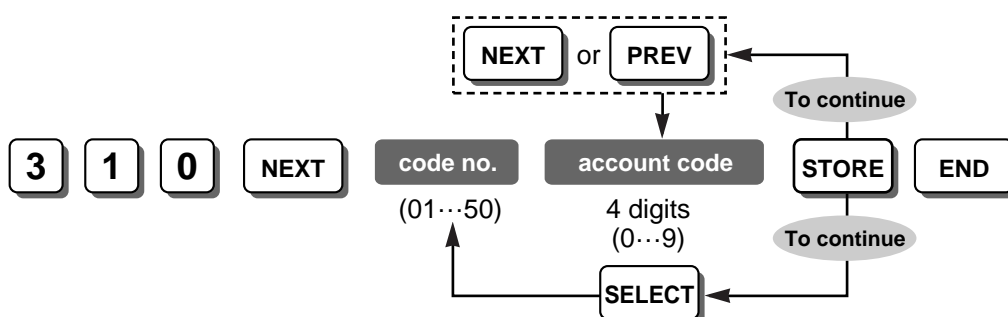
Account Code [310]**Feature & Programming References**

1.5.2.3 Account Code Entry

1.8.2 Toll Restriction (TRS) Override by Account Code

Account Code Mode [605]

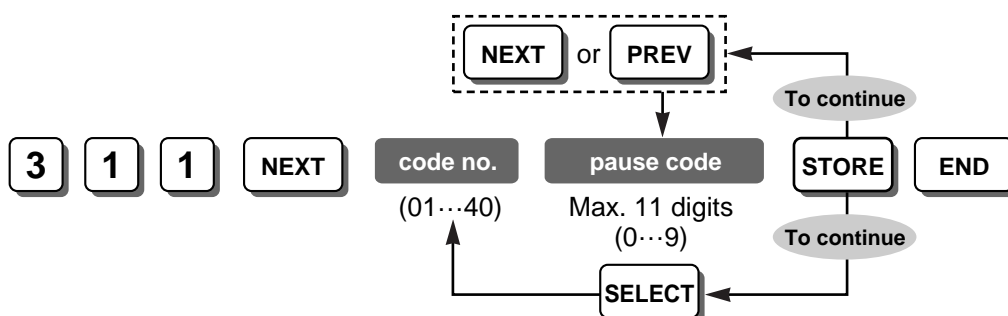
Automatic Pause Insertion Code [311]**Feature & Programming References**

1.5.2.7 Pause Insertion

Pause Time [417]

TRS—Extension Lock Class [312]



Feature & Programming References

- 1.8.1 Toll Restriction (TRS)
- 1.8.4 Extension Lock

ARS Selection [350]

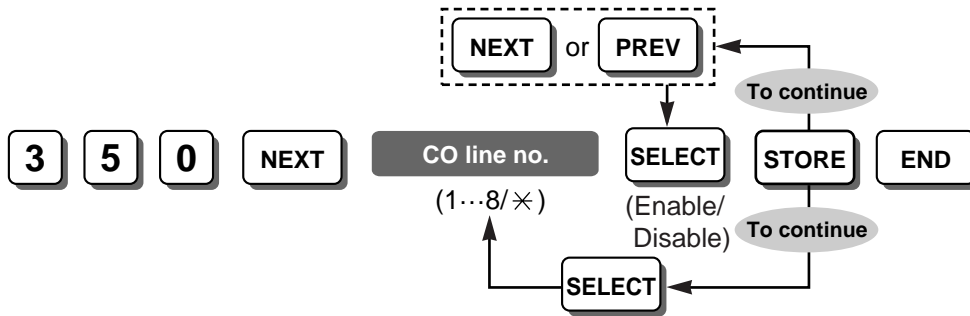

Feature & Programming References

- 1.9.1 Automatic Route Selection (ARS)

Route 1-4 Selection Code [351-354]

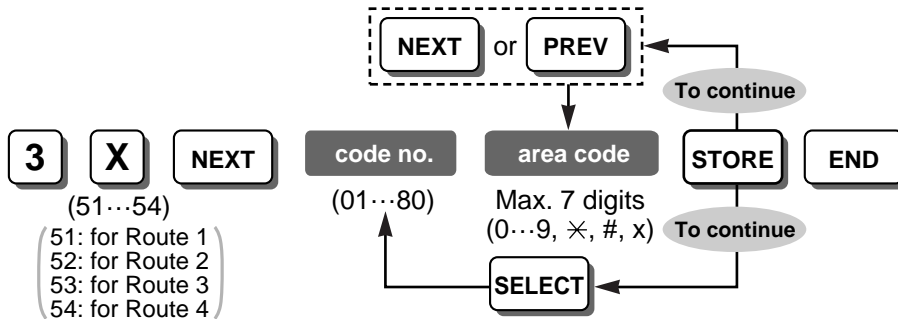

Feature & Programming References

- 1.9.1 Automatic Route Selection (ARS)

Route 1-4 Exception Code [355-358]

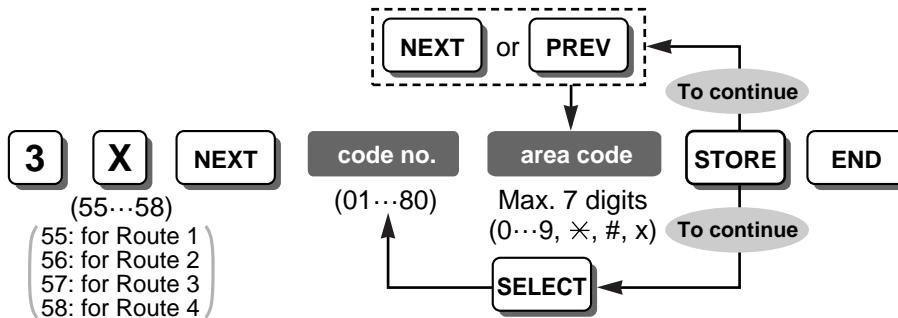

Feature & Programming References

1.9.1 Automatic Route Selection (ARS)

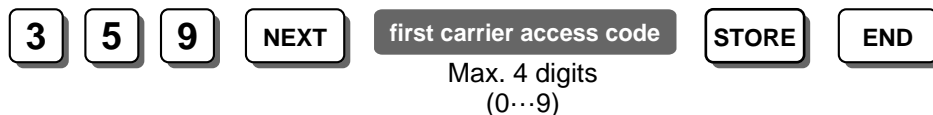
1st Carrier Selection Code [359]**Feature & Programming References**

1.9.1 Automatic Route Selection (ARS)

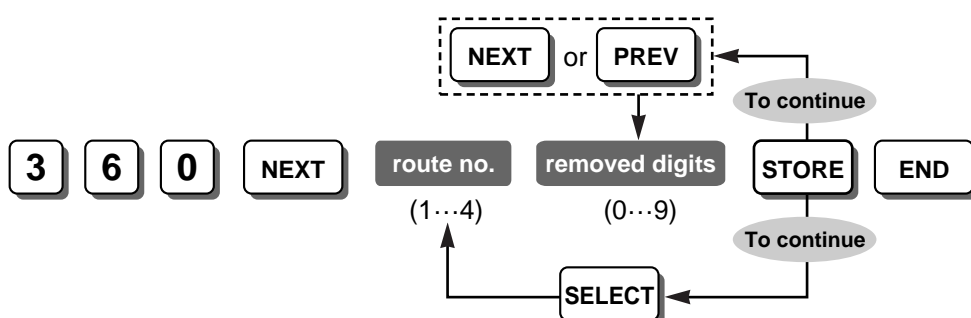
ARS Modification—Removed Digits [360]**Feature & Programming References**

1.9.1 Automatic Route Selection (ARS)

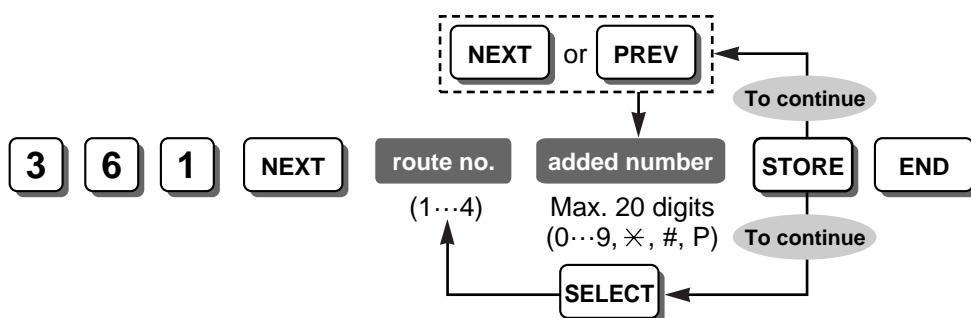
ARS Modification—Added Number [361]**Feature & Programming References**

1.9.1 Automatic Route Selection (ARS)

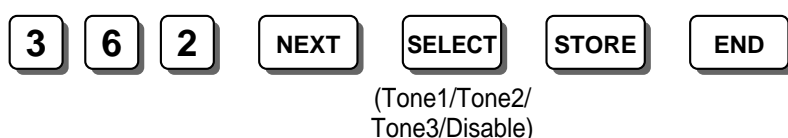
ARS Dial Tone [362]**Feature & Programming References**

1.22.1 Dial Tone

ARS Inter-digit Time [363]



Note

This assignment should be the same as the inter-digit timer assigned in Inter-digit Time [208].

Feature & Programming References

1.9.1 Automatic Route Selection (ARS)

ARS CO Line Group [364]

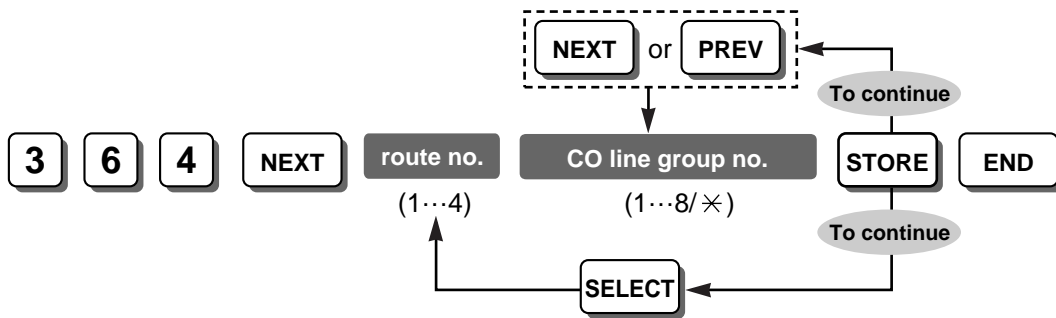

Note

The assignments in Route 1-4 Selection Code [351-354] are effective for this programme.

Feature & Programming References

1.9.1 Automatic Route Selection (ARS)

Route 1-4 Authorisation Code [381-384]

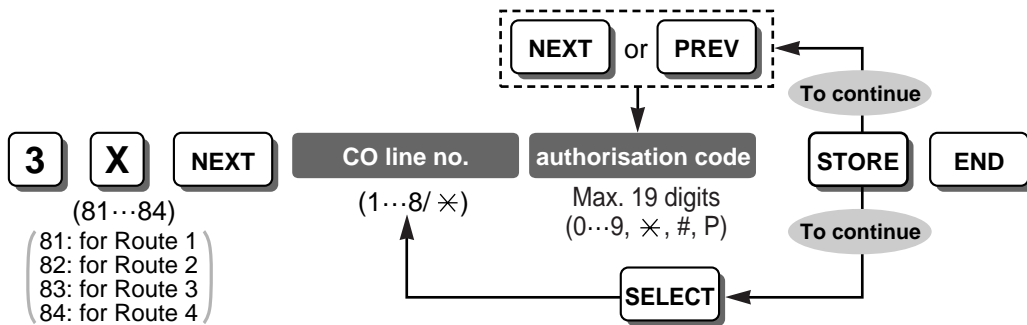

Feature & Programming References

1.9.1 Automatic Route Selection (ARS)

Route 1-4 Itemised Billing [385-388]

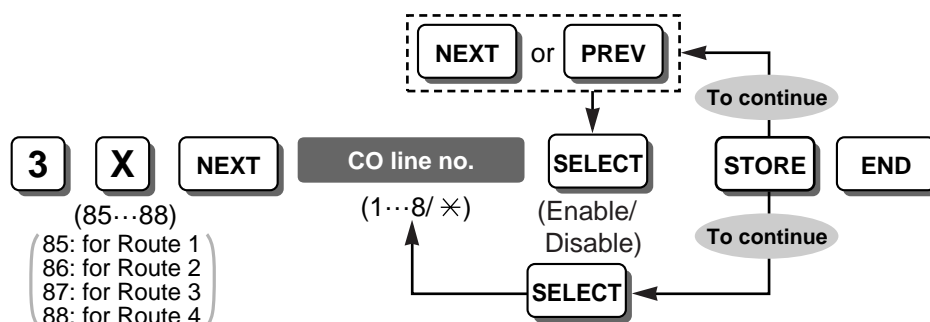

Feature & Programming References

1.9.1 Automatic Route Selection (ARS)

Itemised Billing Code [389]

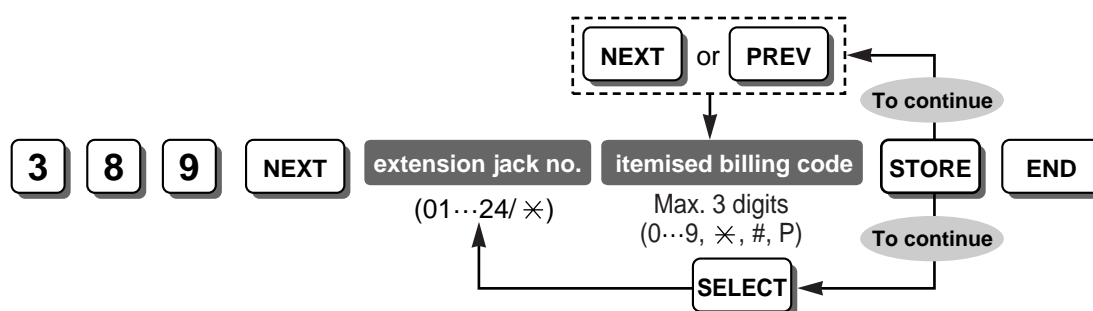

Feature & Programming References

1.9.1 Automatic Route Selection (ARS)

Authorisation and Itemised Billing Code Order [390]

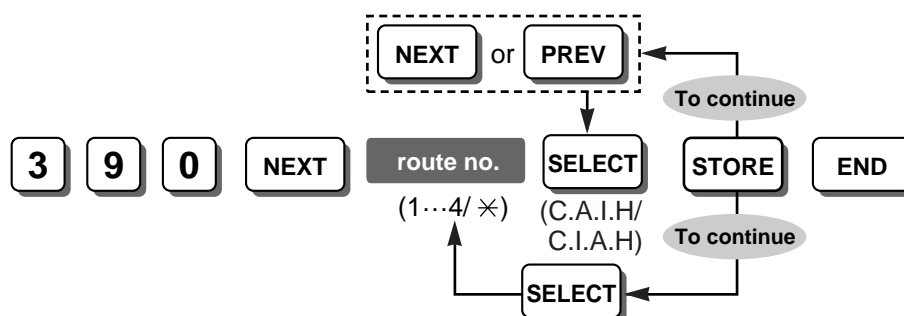

Note

C: Carrier Access Code; A: Authorisation Code; I: Itemised Billing Code; H: Telephone Number

Feature & Programming References

1.9.1 Automatic Route Selection (ARS)

CO Line Connection [400]

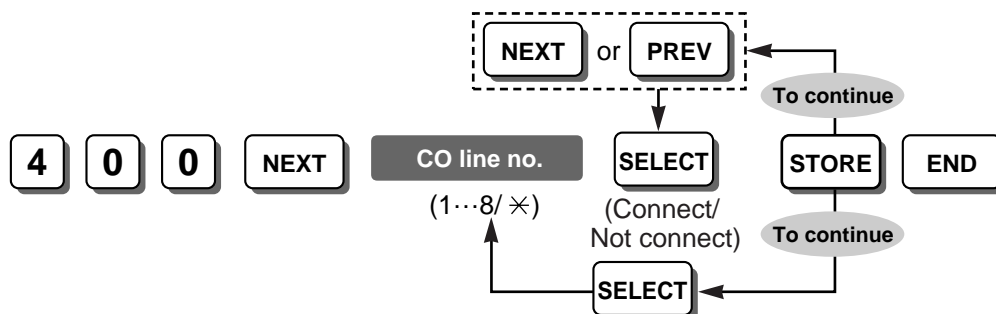

Note

The numbers of outside (CO) line ports that do not have lines connected should be set to "Not connect". The PBX seizes the highest available outside (CO) line number when selecting an idle outside (CO) line automatically. If an unconnected outside (CO) line number is set to "Connect" and is numbered higher than any connected outside (CO) line number, the PBX will try to seize the unconnected outside (CO) line.

Feature & Programming References

- 1.5.3.2 Line Preference—Outgoing
- 1.5.3.3 Outside (CO) Line Access

Dial Mode [401]

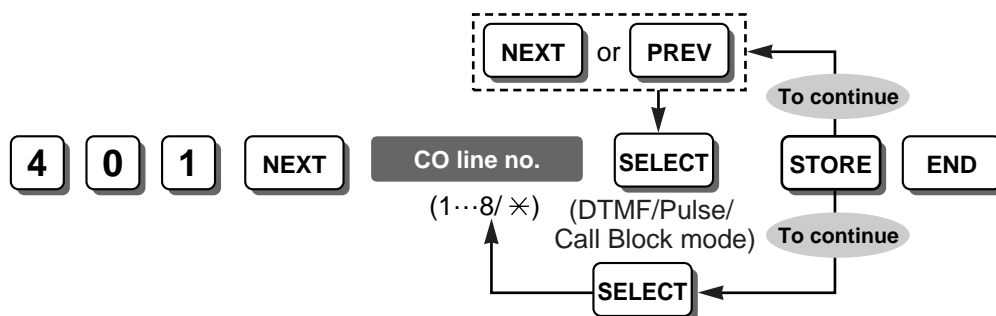

Note

This programme is not available for the AL (Australia) model.

Feature & Programming References

- 1.5.2.4 Dial Type Selection

Pulse Speed [402]

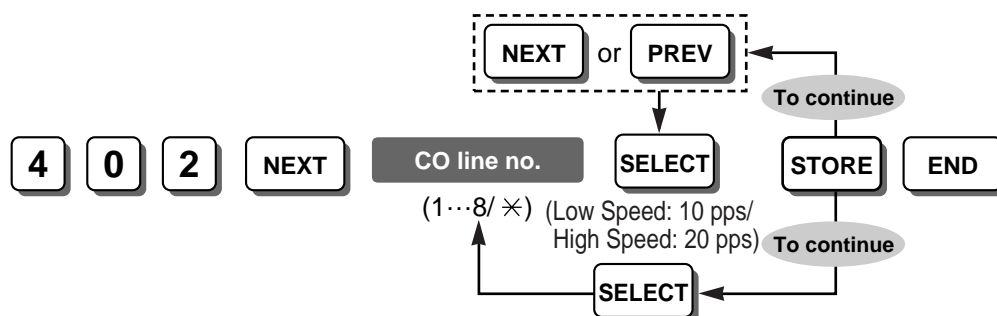

Note

This programme is not available for the AL (Australia) model.

Feature & Programming References

1.5.2.4 Dial Type Selection

Dial Mode [401]

Host PBX Access Code [403]

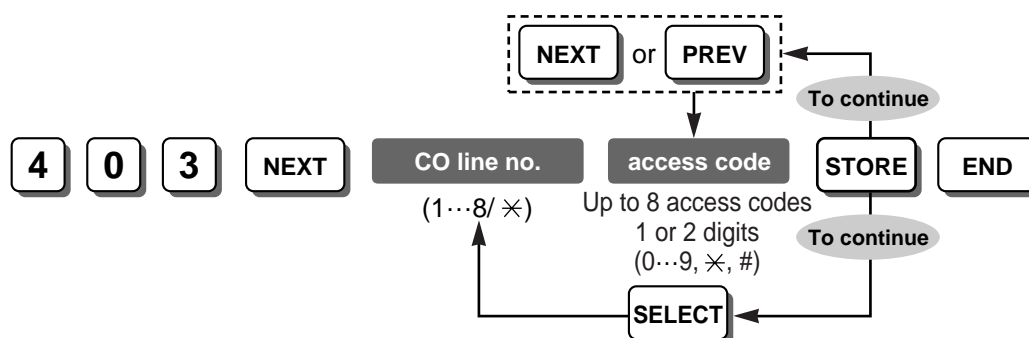

Note

Insert "," (CONF/MESSAGE button) between each access code using the comma button on the overlay. For example, to store access codes 81 and 82 on outside (CO) line 1, programme as follows:
403 NEXT 1 81,82 STORE END

Feature & Programming References

1.5.2.8 Host PBX Access Code (Access Code to the Telephone Company from a Host PBX)

Pause Time [417]

CO Line Group Number [404]

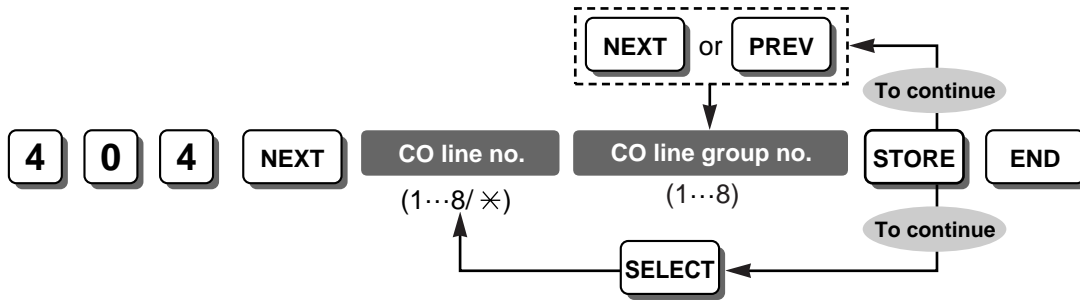

Feature & Programming References

1.5.3.3 Outside (CO) Line Access

2.2.2 Group

Flexible Outward Dialling—Day/Night/Lunch [405-407]

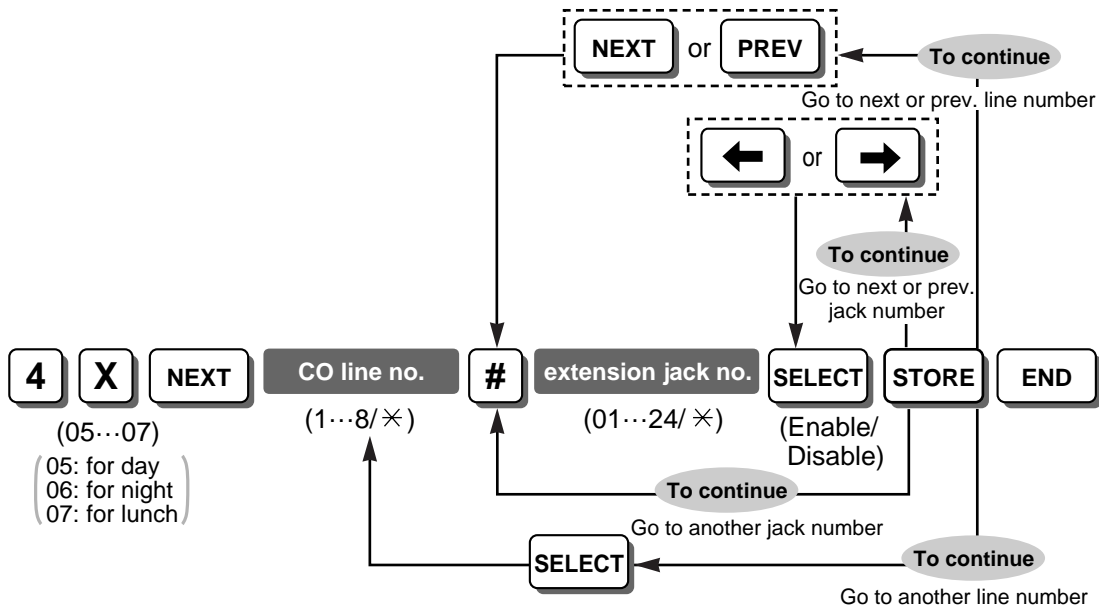

Note

It is impossible to disable all extensions for all outside (CO) lines in each time service mode (day/night/lunch). In each mode, at least one extension must be allowed to make an outside (CO) line call.

Feature & Programming References

1.5.3.2 Line Preference—Outgoing

1.5.3.3 Outside (CO) Line Access

Feature & Programming References

1.2.3 Direct Inward System Access (DISA) Ring

1.4.1.2 Line Preference—Incoming

CO Line Mode—Day/Night/Lunch [414-416]

<To select Normal, UCD, and/or MODEM>

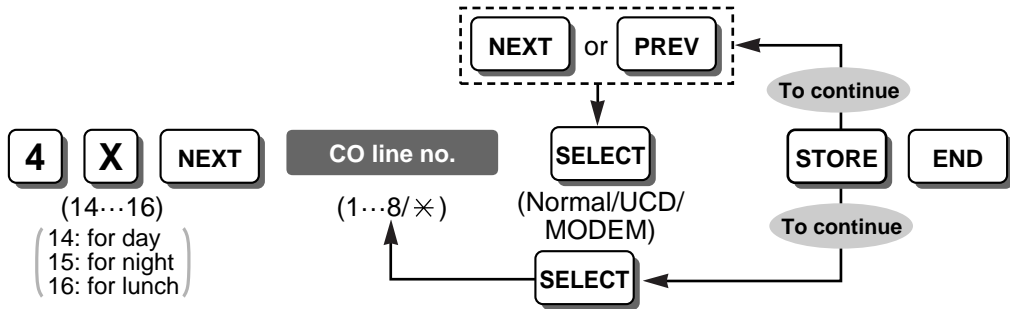

<To select BV>

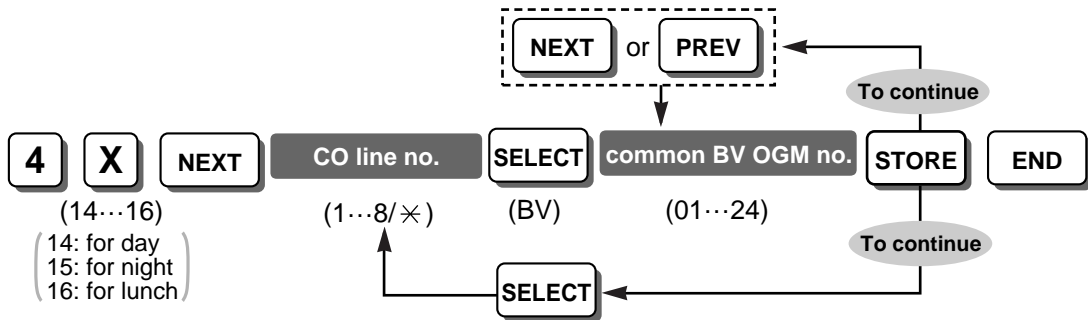

<To select DISA>

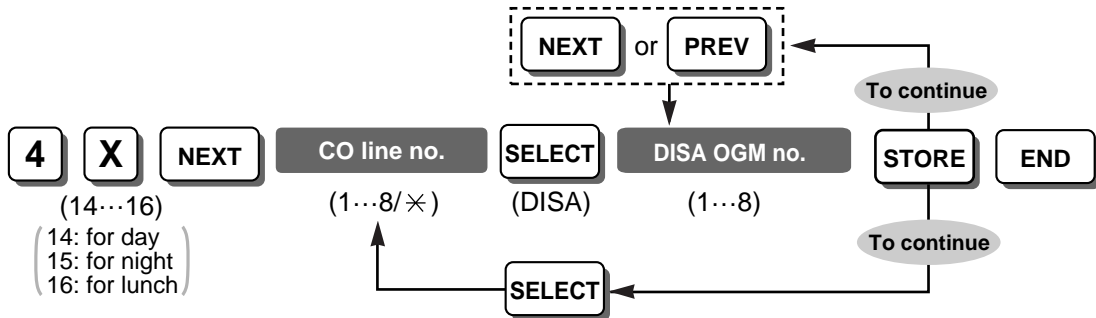

<To select DIL>

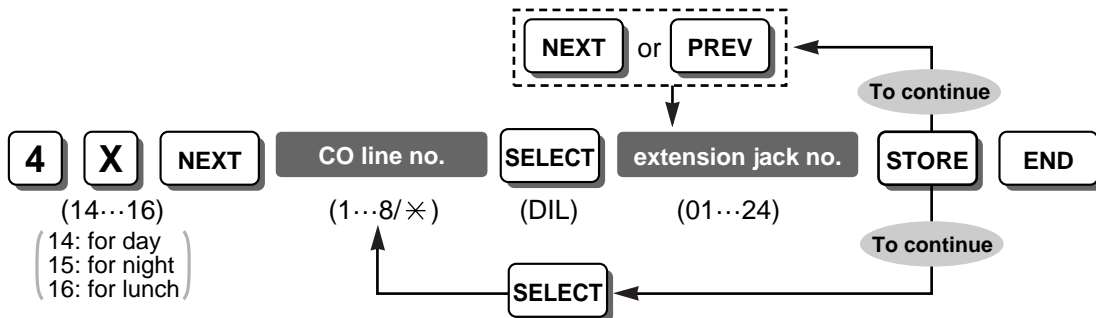

Notes

- When you select "UCD", it is necessary to assign an extension group as the UCD group in UCD Group [520].
- After you select "BV", do not change Operator Assignment [008].

Feature & Programming References

- 1.1.1.1 Direct In Line (DIL)
- 1.2.2 Uniform Call Distribution (UCD)
- 1.15.6 Direct Inward System Access (DISA)
- 1.15.7 Built-in Voice Message (BV)
- 2.3.1 PC Programming
- Flexible Ringing—Day/Night/Lunch [408-410]

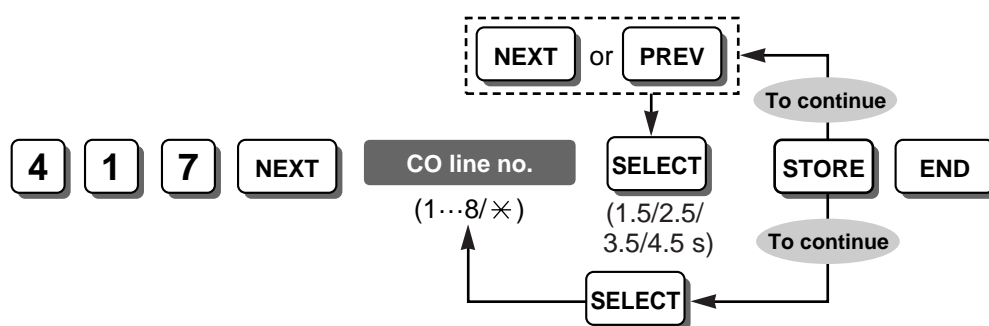
Pause Time [417]**Feature & Programming References**

- 1.5.2.7 Pause Insertion
- 1.5.2.8 Host PBX Access Code (Access Code to the Telephone Company from a Host PBX)
- Automatic Pause Insertion Code [311]
- Host PBX Access Code [403]

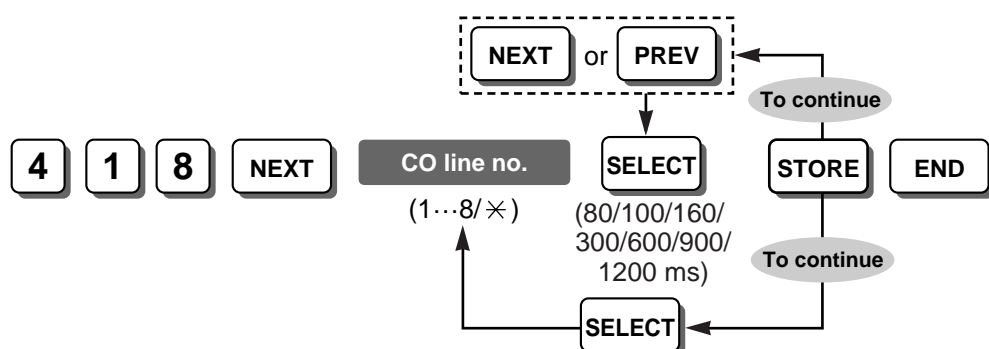
Flash/Recall Time [418]**Feature & Programming References**

- 1.10.6 Flash/Recall
- 1.10.7 External Feature Access (EFA)

Automatic Designated Line Access [419]

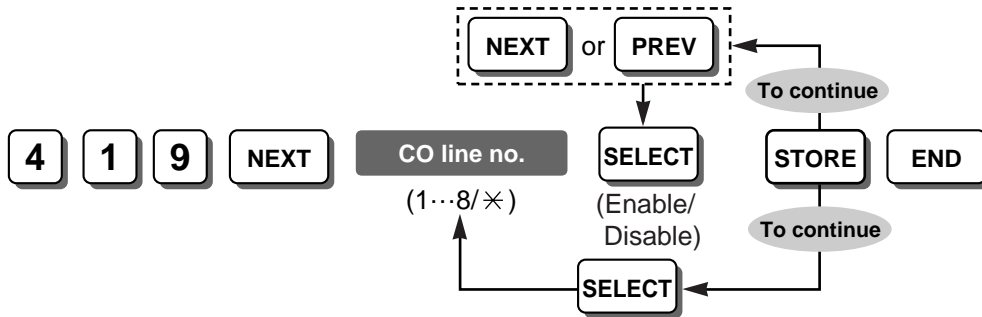

Feature & Programming References

- 1.5.3.2 Line Preference—Outgoing
- 1.5.3.3 Outside (CO) Line Access
- Automatic Line Access [121]

CPC Signal Detection—Incoming [420]

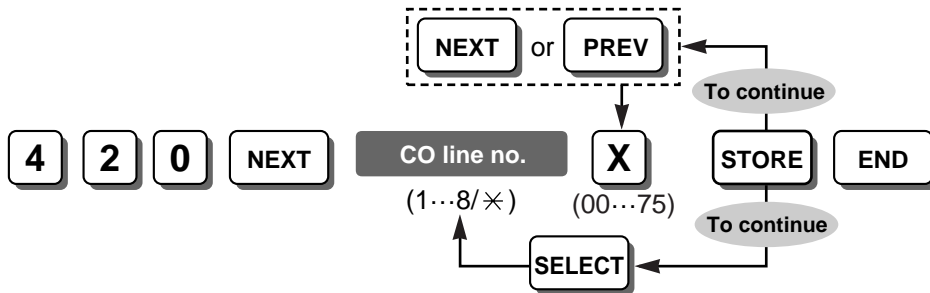

Note

CPC signal detect time selection number:

00: Disable; 01–75: 22–614 ms (detect time: 8 ms increments)

Feature & Programming References

- 1.10.10 Calling Party Control (CPC) Signal Detection

CPC Signal Detection—Outgoing [421]

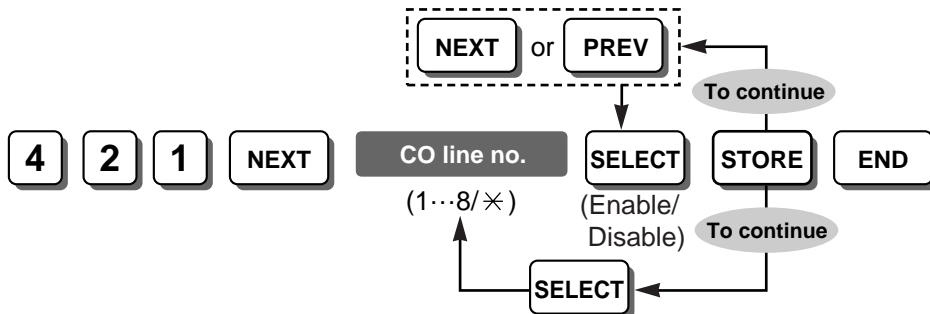

Note

When this programme is disabled, CPC Signal Detection is only activated during an incoming outside (CO) line call.

Feature & Programming References

1.10.10 Calling Party Control (CPC) Signal Detection

Disconnect Time [422]

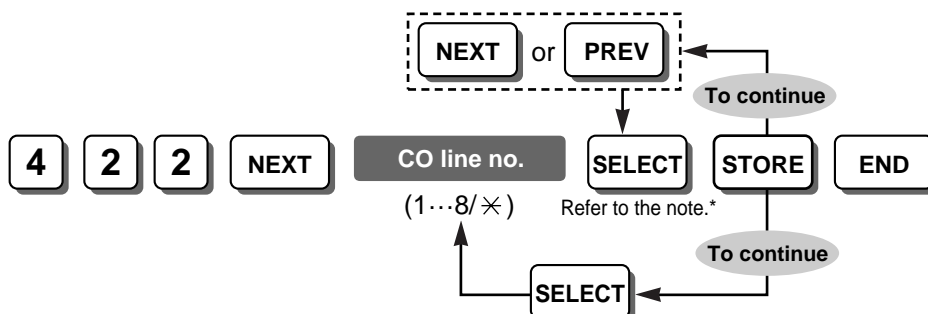

Notes

- * The disconnect signal lengths that can be selected depend on your country/area as follows:
For United Kingdom: 0.5 s, 2.0 s, 4.0 s
For South Africa: 0.8 s, 1.5 s, 4.0 s
For Others: 0.5 s, 1.5 s, 4.0 s
- The time you select must be longer than the requirements of your telephone company or host PBX.

Feature & Programming References

1.10.6 Flash/Recall

CO Line Ring Tone Pattern [423]

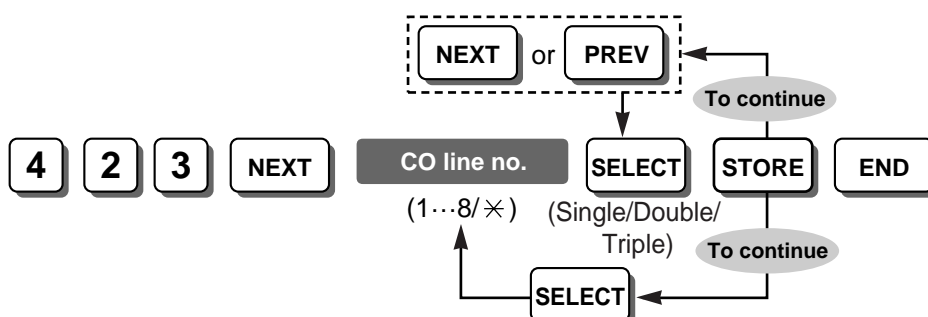

Note

It is recommended that you set a different ring tone pattern from the ring tone patterns specified in Extension Ring Tone Pattern [115] and Doorphone Ring Tone Pattern [706].

Feature & Programming References

1.1.3.3 Ring Tone Pattern Selection

Polarity Reverse Detection [424]

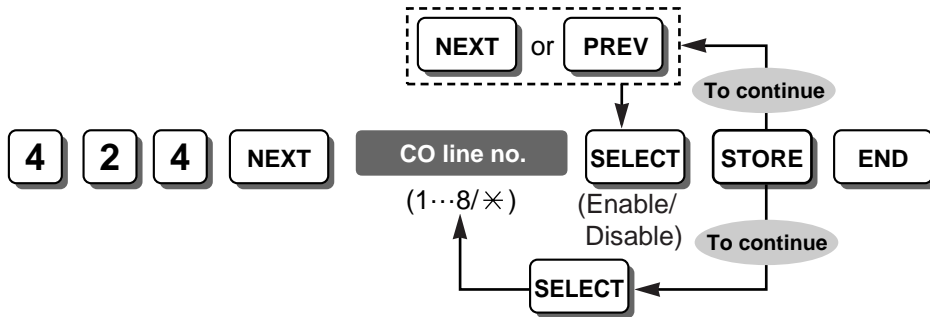

Feature & Programming References

1.5.2.5 Reverse Circuit

Collect Call Block [425] (Brazil only)

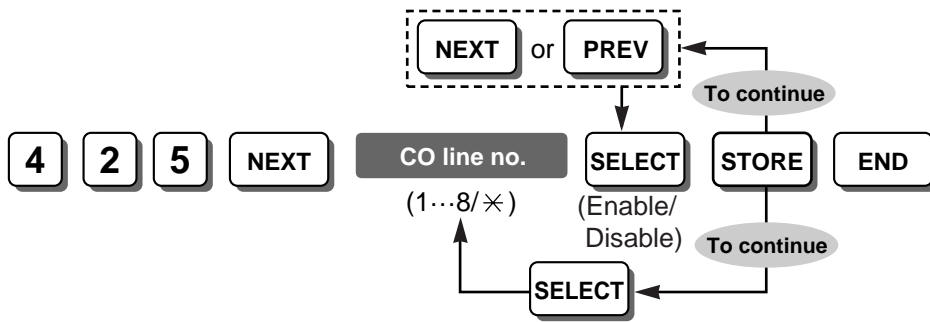

Note

This programme enables the PBX to automatically reject collect calls from the telephone company.

Distinctive Ring Detection (DRD) [426] (New Zealand only)

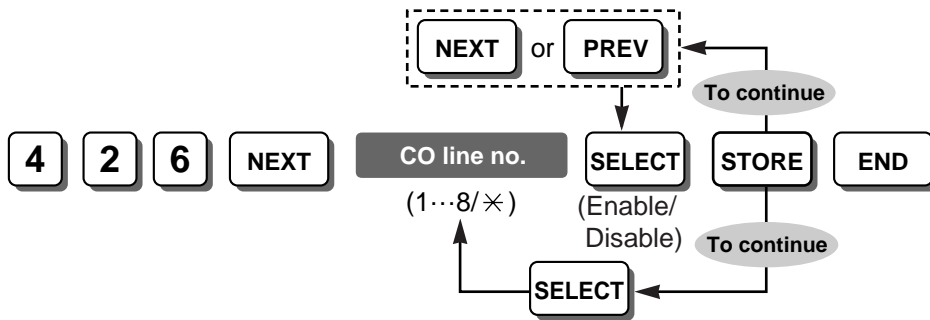

Feature & Programming References

1.1.3.4 Distinctive Ring Detection (DRD) for New Zealand

DRD Ring Pattern 2 Extension Assignment—Day/Night/Lunch [427-429] (New Zealand only)

DRD Ring Pattern 3 Extension Assignment—Day/Night/Lunch [430-432] (New Zealand only)

DRD Ring Pattern 2 Extension Assignment—Day/Night/Lunch [427-429] (New Zealand only)

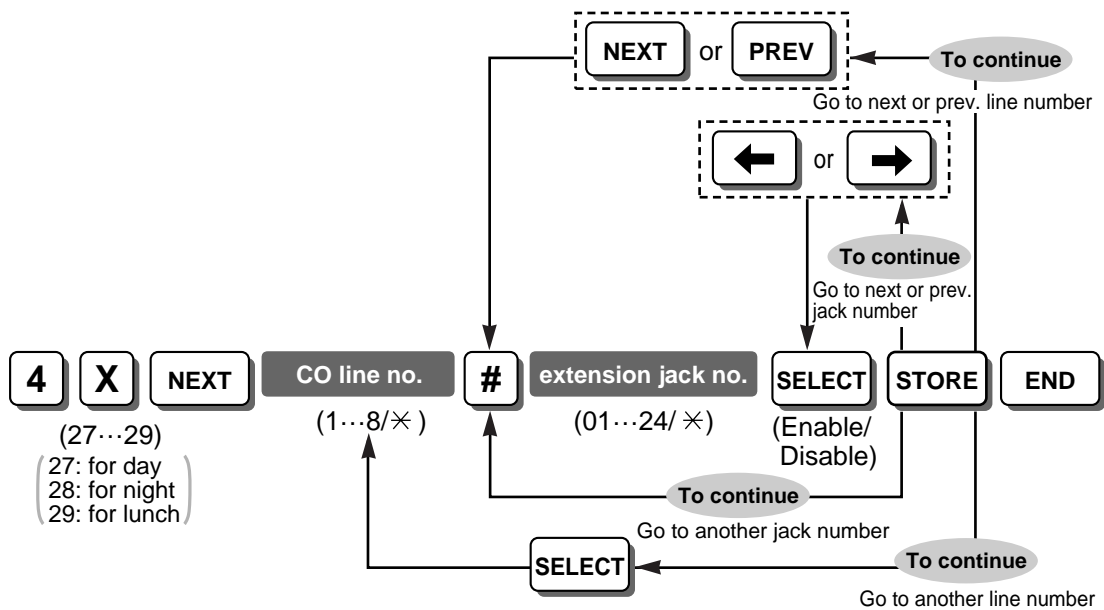

Note

This is effective only when the DRD feature is enabled in Distinctive Ring Detection (DRD) [426] (New Zealand only).

Feature & Programming References

1.1.3.4 Distinctive Ring Detection (DRD) for New Zealand

DRD Ring Pattern 3 Extension Assignment—Day/Night/Lunch [430-432] (New Zealand only)

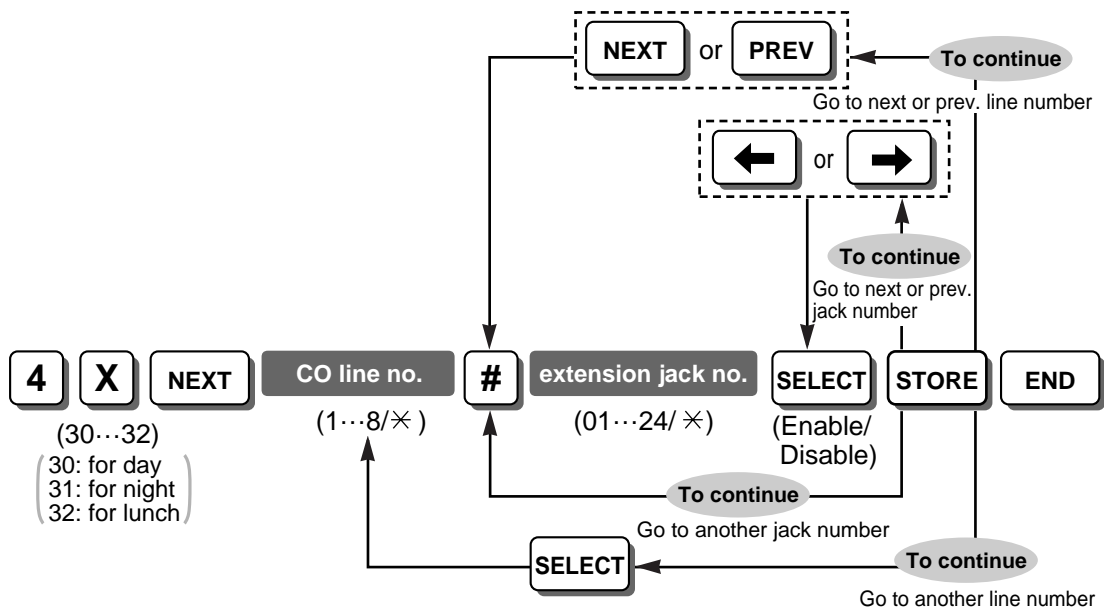

Note

This is effective only when the DRD feature is enabled in Distinctive Ring Detection (DRD) [426] (New Zealand only).

Feature & Programming References

1.1.3.4 Distinctive Ring Detection (DRD) for New Zealand

DRD Pattern 2 and 3 Ring Tone [433-434] (New Zealand only)

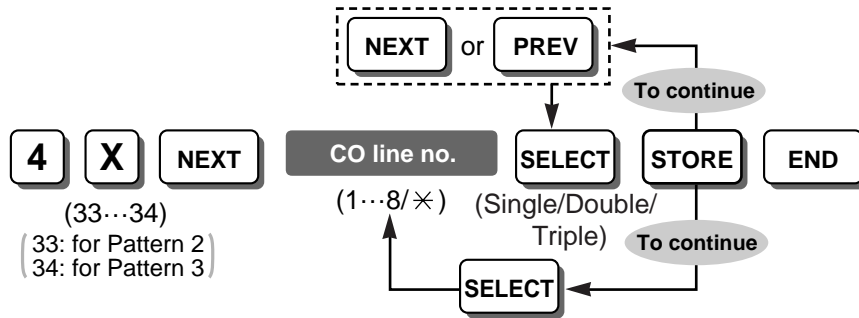

Feature & Programming References

1.1.3.4 Distinctive Ring Detection (DRD) for New Zealand

DISA IRNA to BV—Day/Night/Lunch [438-440]

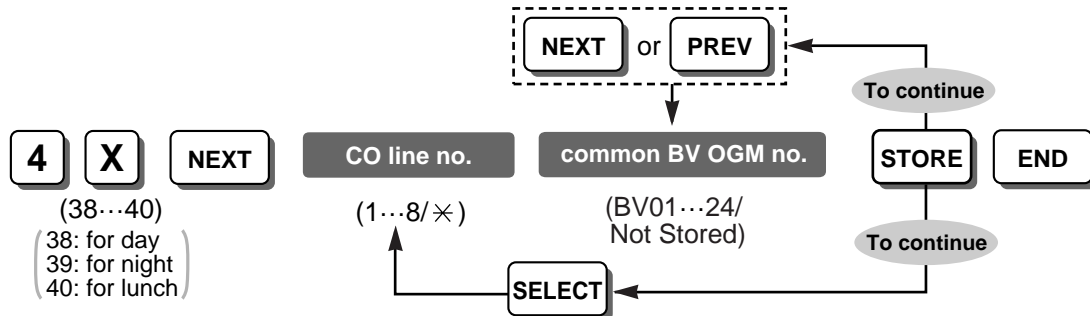

Feature & Programming References

1.15.7 Built-in Voice Message (BV)

Call Charge Calculation [441]

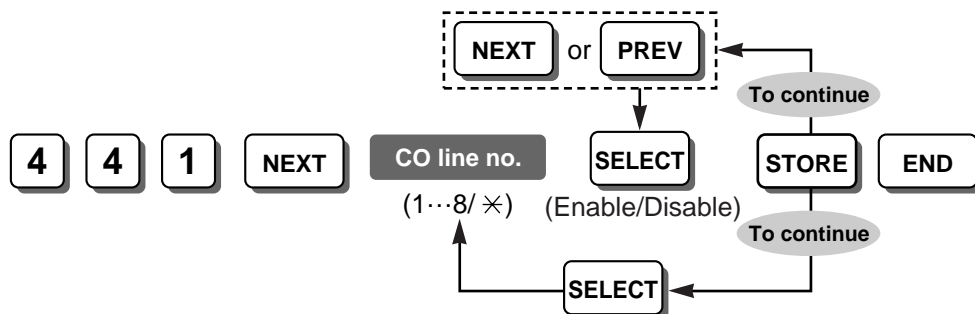

Feature & Programming References

1.20.2 Call Charge Calculation

Call Charge Table Assignment [442]

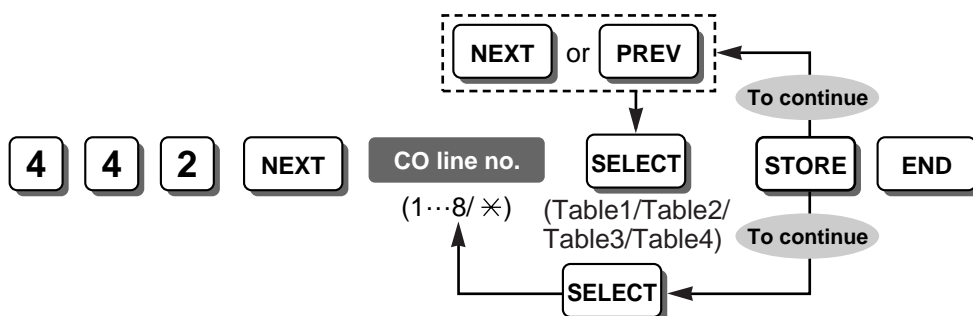

Feature & Programming References

1.20.2 Call Charge Calculation

DISA Incoming Call Dial Mode [500]



Note

Without AA: Available destinations are extension numbers assigned in Extension Number [009], Outside (CO) Line Access numbers (9/0 [for New Zealand: 1 or 9], 81 through 88), and the Operator Call number (0 or 9)
 With AA: Available destinations are numbers available in "Without AA" mode and numbers (0 through 9) assigned in DISA Built-in AA [501]

Feature & Programming References

1.15.6 Direct Inward System Access (DISA)

DISA Built-in AA [501]

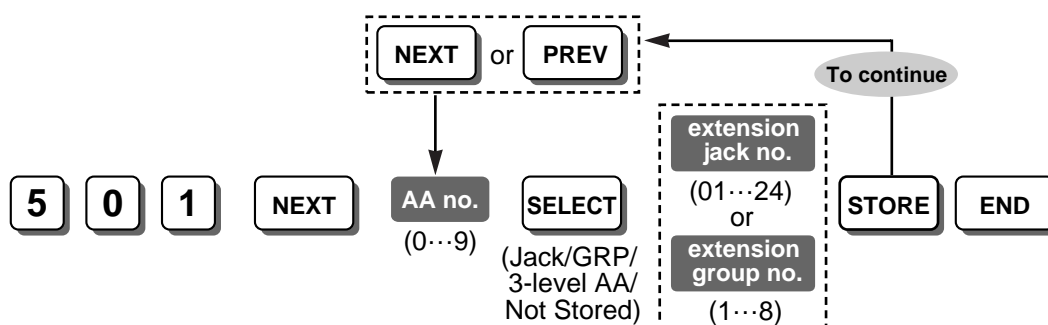

Note

If you would like to use the Automatic Line Access number (9/0 [for New Zealand: 1 or 9]) and/or Operator Call number in AA mode, do not assign AA number(s) that correspond to Automatic Line Access or Operator Call numbers (9 and/or 0).

Feature & Programming References

1.15.6 Direct Inward System Access (DISA)

FAX Connection [503]

5 0 3 NEXT extension jack no. STORE END
 (01...24/Disable)

Notes

- To delete (disable) an extension jack number, press CLEAR in the extension jack number step.
- The assigned extension will automatically have the Data Line Security feature set.

Feature & Programming References

1.15.6 Direct Inward System Access (DISA)

DISA Delayed Answer Time [504]

5 0 4 NEXT SELECT STORE END
 (0/3/6/12 s)

Feature & Programming References

1.15.6 Direct Inward System Access (DISA)

DISA Wait Time after OGM [505]

5 0 5 NEXT SELECT STORE END
 (0/5/10/15 s)

Feature & Programming References

1.15.6 Direct Inward System Access (DISA)

DISA Busy Mode [506]

<To select Disconnect or Call Waiting>

5 0 6 NEXT SELECT STORE END
 (Disconnect/
 Call Waiting)

<To select DISA>

5 0 6 NEXT SELECT DISA OGM no. STORE END
 (DISA) (1...8)

Feature & Programming References

1.15.5 Outgoing Message (OGM) for DISA/UCD

1.15.6 Direct Inward System Access (DISA)

DISA Intercept Mode [507]

5 0 7 NEXT SELECT STORE END
 (Intercept/
 Disconnect)

Feature & Programming References

- 1.1.1.2 Intercept Routing
- 1.15.6 Direct Inward System Access (DISA)
- 1.19 Voice Mail Features

DISA Ring Time before Intercept [508]

(10/20/30/
40/60/120 s)

Feature & Programming References

- 1.1.1.2 Intercept Routing
- 1.15.6 Direct Inward System Access (DISA)
- DISA Intercept Mode [507]

DISA Ring Time after Intercept [509]

(10/20/30/
40/60/120 s)

Feature & Programming References

- 1.1.1.2 Intercept Routing
- 1.15.6 Direct Inward System Access (DISA)
- DISA Intercept Mode [507]
- DISA Ring Time before Intercept [508]

DISA No Dial Mode [510]

(Intercept/
Disconnect)

Feature & Programming References

- 1.15.6 Direct Inward System Access (DISA)

DISA Security Mode [511]

(Trunk/All/
None Security)

Note

Trunk Security: Requires the caller to enter a DISA security code assigned in DISA Security Code [512] before making an outside (CO) line call.

All Security: Requires the caller to enter a DISA security code before making either an outside (CO) line or intercom call.

No Security: Allows the caller to make either an outside (CO) line or intercom call without entering a DISA security code.

Feature & Programming References

1.15.6 Direct Inward System Access (DISA)

DISA Security Code [512]

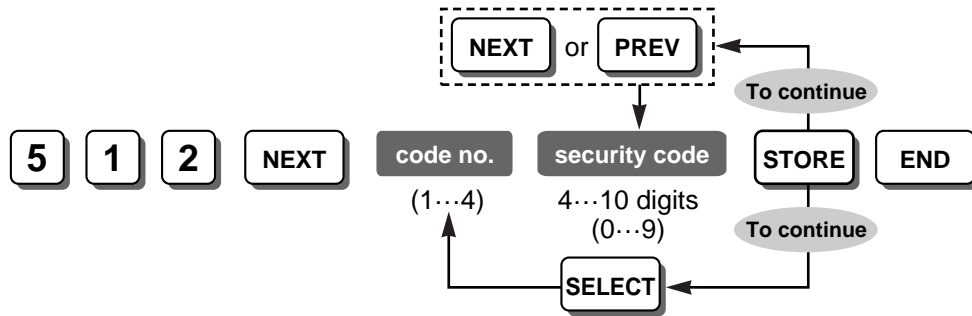

WARNING

There is a risk that fraudulent telephone calls will be made using the Outside-to-Outside (CO-to-CO) Line Call feature of DISA.

The cost of such calls will be billed to the owner/renter of the PBX.

To protect the PBX from this kind of fraudulent use, we strongly recommend:

- a) Enabling DISA security (Trunk Security or All Security).
- b) Maintaining the secrecy of passwords.
- c) Selecting passwords that are complex and random, so that they cannot be easily guessed.
- d) Changing passwords regularly.

Notes

- This setting is required if "Trunk Security" or "All Security" is selected in DISA Security Mode [511].
- Each DISA security code should be unique.
- The number of digits for DISA security codes is selected in DISA Security Code Digits [530].

Feature & Programming References

1.15.6 Direct Inward System Access (DISA)

DISA Security Mode [511]

Cyclic Tone Detection [513]

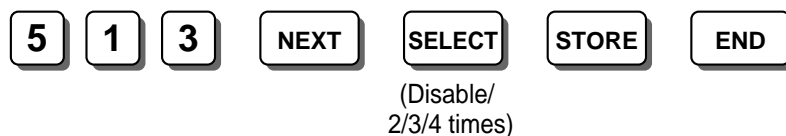

Feature & Programming References

1.15.6 Direct Inward System Access (DISA)

FAX Tone Detection [514]



Feature & Programming References

1.15.6 Direct Inward System Access (DISA)

FAX Connection [503]

Intercept Time for Internal DISA [515]

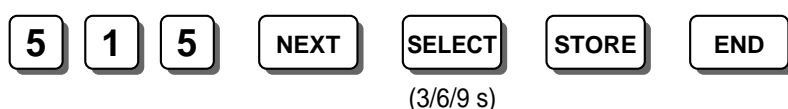

Feature & Programming References

1.15.6 Direct Inward System Access (DISA)

DISA No Dial Mode [510]

DISA Incoming Assignment [516]

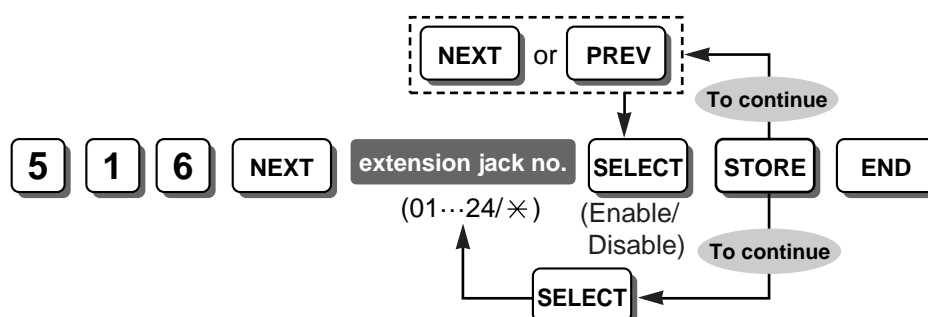

Feature & Programming References

1.15.6 Direct Inward System Access (DISA)

DISA AA Wait Time [517]



Feature & Programming References

1.15.6 Direct Inward System Access (DISA)

DISA Built-in AA [501]

DISA Tone after Security Code [518]

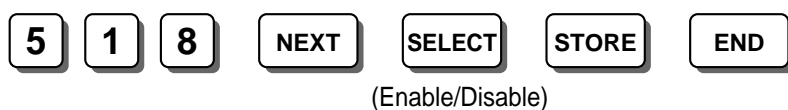

Feature & Programming References

1.15.6 Direct Inward System Access (DISA)

DISA Security Code [512]

OGM Mute Time [519]

5 1 9 NEXT SELECT STORE END
 (0/2/4/6 s)

Feature & Programming References

- 1.15.6 Direct Inward System Access (DISA)
- 1.15.7 Built-in Voice Message (BV)

UCD Group [520]

5 2 0 NEXT extension group no. STORE END
 (1...8)

Feature & Programming References

- 1.2.2 Uniform Call Distribution (UCD)
- 2.2.2 Group

UCD Busy Waiting Time [521]

5 2 1 NEXT waiting time SELECT STORE END
 (1...32 min/1...59 s) (min/s)

Feature & Programming References

- 1.2.2 Uniform Call Distribution (UCD)
- UCD Busy Mode [523]

UCD OGM Message Interval Time [522]

5 2 2 NEXT SELECT STORE END
 (30 s/
 1/1.5/2 min)

Feature & Programming References

- 1.2.2 Uniform Call Distribution (UCD)
- UCD Busy Waiting Time [521]

UCD Busy Mode [523]

<To select Intercept-Normal or Disconnect>

5 2 3 NEXT SELECT STORE END
 (Intercept-Normal/
 Disconnect)

<To select Intercept-DISA or Disconnect-OGM>

5 2 3 NEXT SELECT DISA/UCD OGM no. STORE END
 (Intercept-DISA/
 Disconnect-OGM) (1...8)

Feature & Programming References

1.2.2 Uniform Call Distribution (UCD)

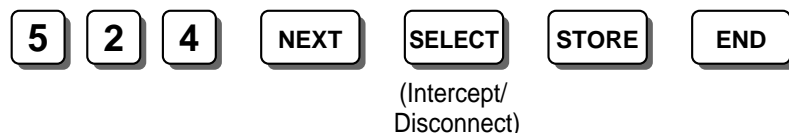
UCD Intercept Mode [524]**Feature & Programming References**

1.2.2 Uniform Call Distribution (UCD)

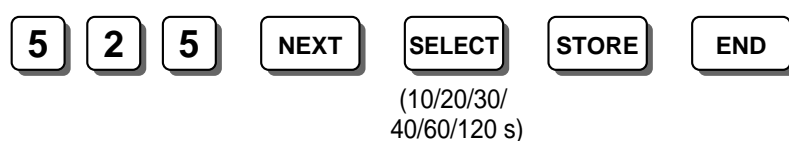
UCD Ring Time before Intercept [525]**Feature & Programming References**

1.2.2 Uniform Call Distribution (UCD)

UCD Intercept Mode [524]

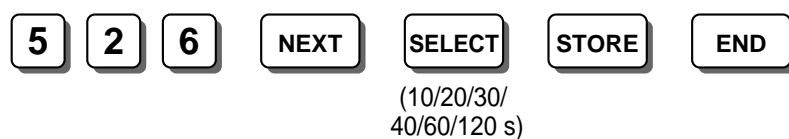
UCD Ring Time after Intercept [526]**Feature & Programming References**

1.2.2 Uniform Call Distribution (UCD)

UCD Intercept Mode [524]

UCD Waiting Message [527]**Feature & Programming References**

1.2.2 Uniform Call Distribution (UCD)

1.15.5 Outgoing Message (OGM) for DISA/UCD

DISA Security Code Digits [530]

Note

When this setting is changed, DISA security codes that have already been assigned in DISA Security Code [512] will be cleared.

Feature & Programming References

1.15.6 Direct Inward System Access (DISA)

DISA Ringback Tone [531]



(Ringback Tone/
Hold Music)

Feature & Programming References

1.15.6 Direct Inward System Access (DISA)

3-level AA Assignment [540-549]

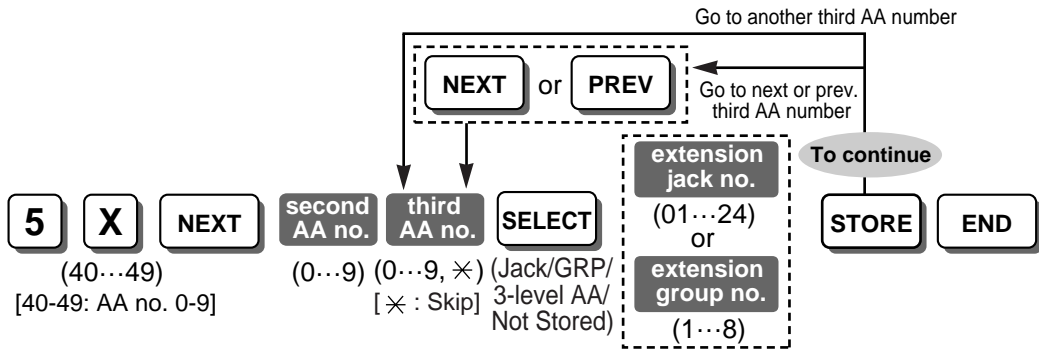

Notes

- This programme is available only when "3-level AA" is selected for each AA number in DISA Built-in AA [501].
- Only when you select "*" as the third AA number, you can select "3-level AA" in the next step.

Feature & Programming References

1.15.6 Direct Inward System Access (DISA)

Clear All OGMs of DISA/UCD [599]



Feature & Programming References

1.15.5 Outgoing Message (OGM) for DISA/UCD

Extension Group [600]

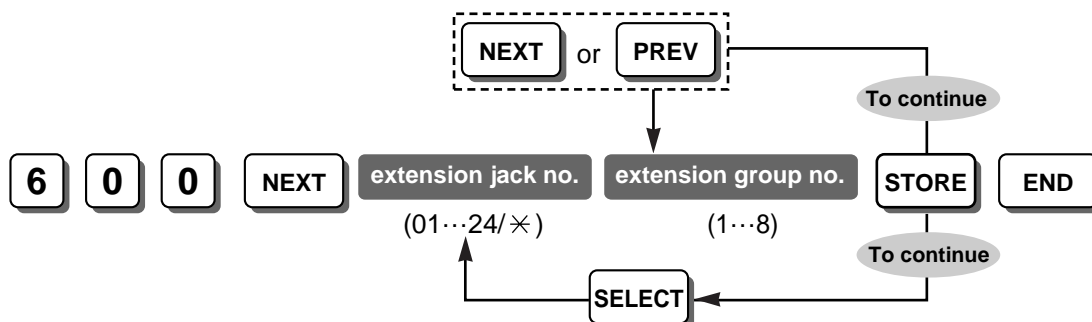

Feature & Programming References

- 1.2.1 Idle Extension Hunting
- 2.2.2 Group

TRS-COS—Day/Night/Lunch [601-603]

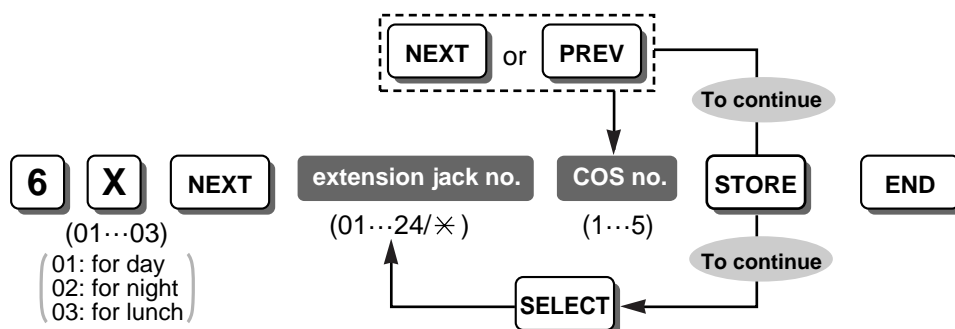

Feature & Programming References

- 1.8.1 Toll Restriction (TRS)
- 2.2.1 Class of Service (COS)

Extension Name [604]

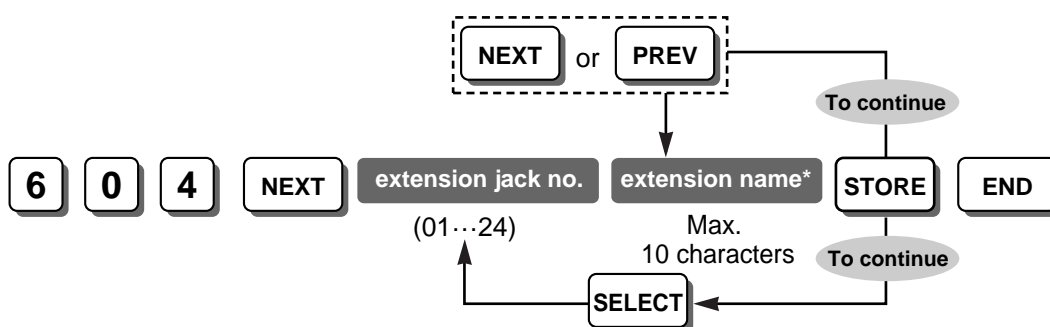

Note

* An extension name can be entered using a PT's dialling buttons. The displayed character varies depending on the number of times that the dialling button is pressed. It is possible to toggle between "Alphabet mode" and "Numeral mode" by pressing SELECT.

Feature & Programming References

- 1.5.1.1 Intercom Call

3.3.1 Programming Instructions—Entering Characters

Account Code Mode [605]

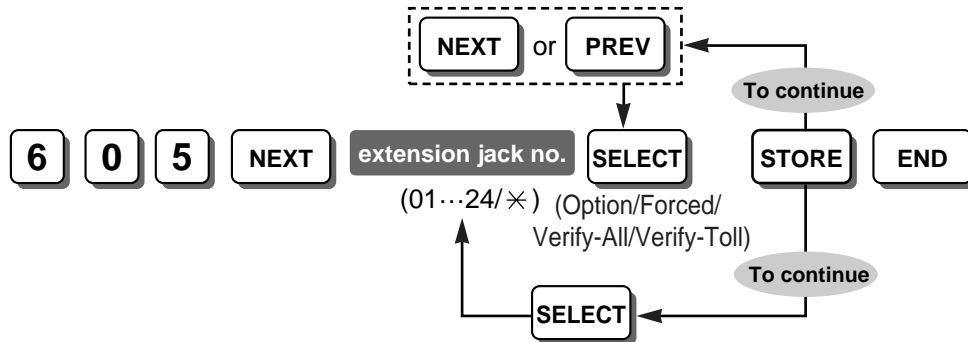

Feature & Programming References

- 1.5.2.3 Account Code Entry
- 1.8.2 Toll Restriction (TRS) Override by Account Code
- Account Code [310]

Call Transfer to CO Line [606]

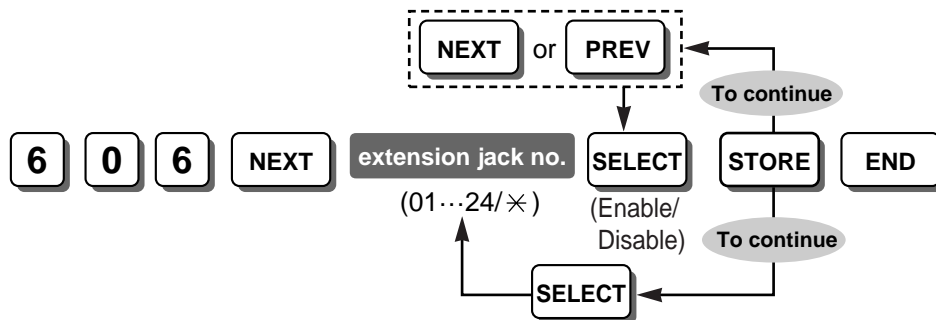

Feature & Programming References

- 1.11.1 Call Transfer
- 1.13.1.2 Conference

Call Forwarding to CO Line [607]

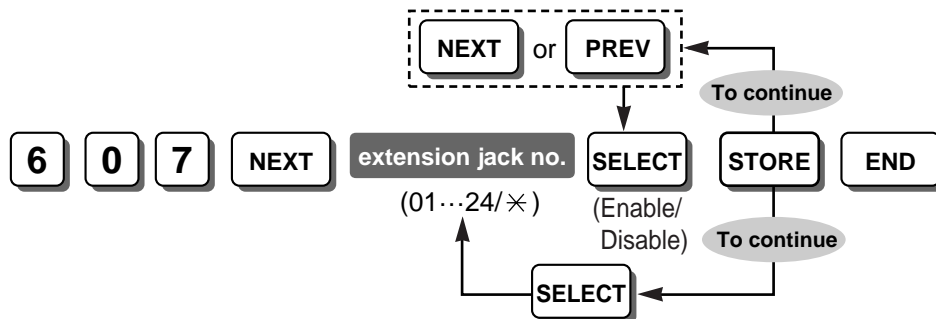

Feature & Programming References

- 1.3.1.2 Call Forwarding (FWD)

Executive Busy Override [608]

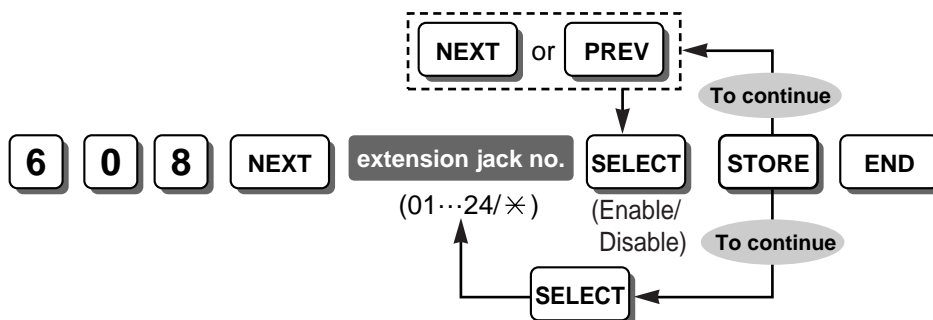

Feature & Programming References

1.7.2 Executive Busy Override

DND Override [609]

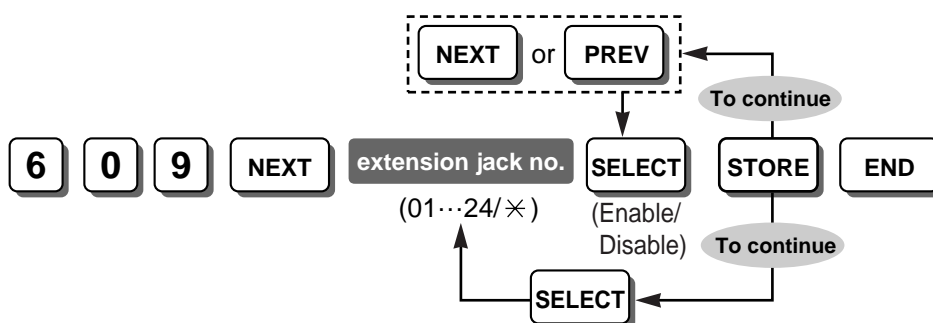

Feature & Programming References

1.3.1.3 Do Not Disturb (DND)

Paralleled Telephone [610]

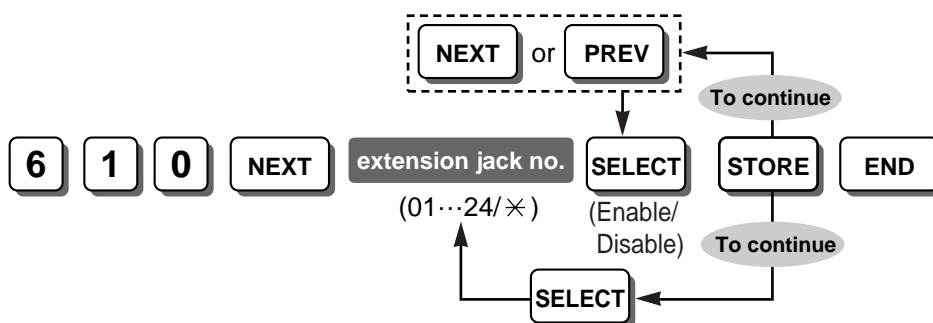

Feature & Programming References

1.10.9 Paralleled Telephone

TAM Extension [611]

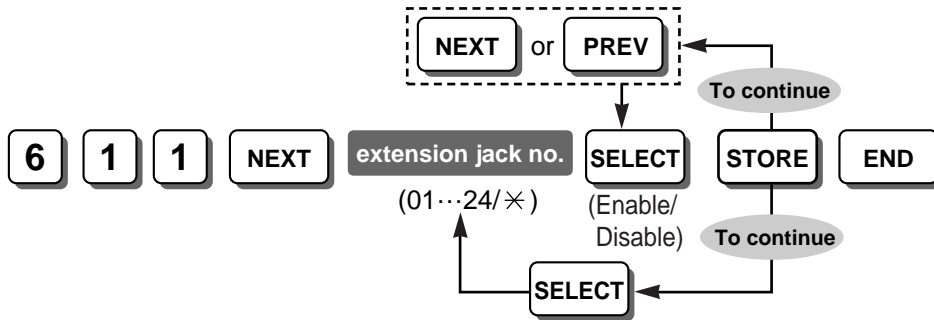

Feature & Programming References

1.4.1.3 Call Pickup

Room Monitor [612]

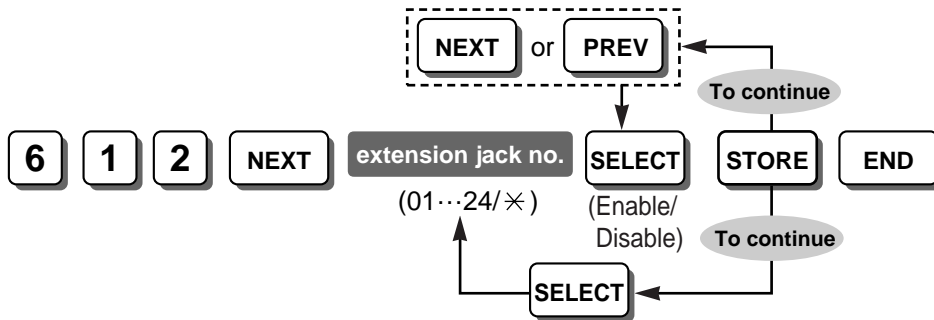

Note

Extensions that are to be monitored must have their jacks set to "Enable" in this programme in advance.

Feature & Programming References

1.10.2 Room Monitor

CO Line Call Duration Limitation [613]

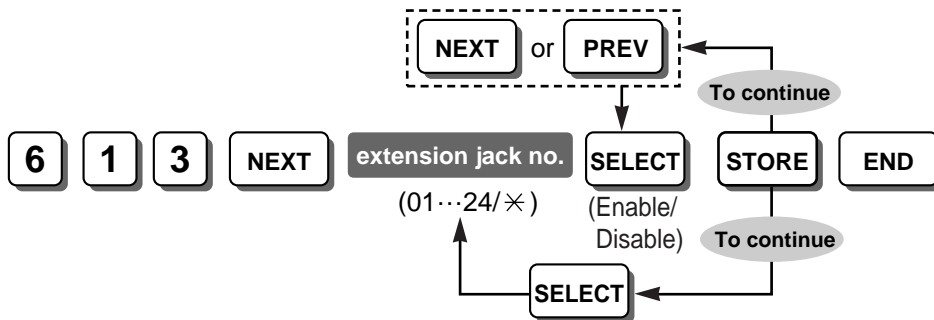

Feature & Programming References

1.10.8 Outside (CO) Line Call Limitation
 Extension-to-CO Line Call Duration [212]

Internal Pulse Detection [614]

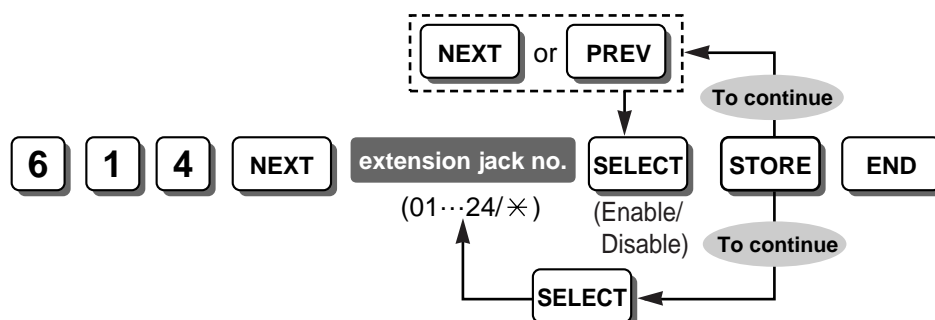

Feature & Programming References

1.12.1 Call Hold

Hookswitch Flash Timing Range [207]

LCD Language [615]

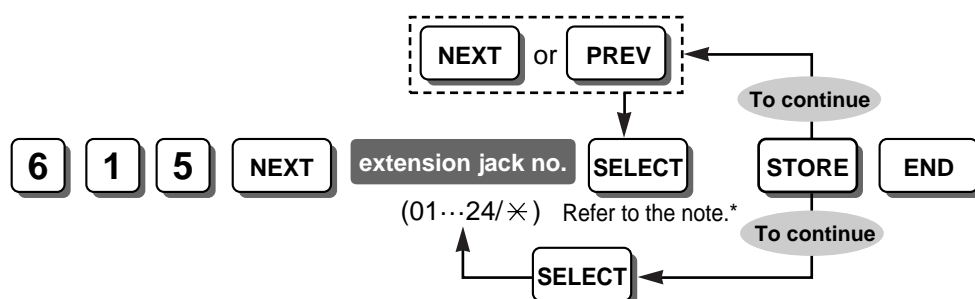

Notes

- * The following languages are available for the LCD:
English; Spanish; Portuguese; Russian; Greek; Czech; Hungarian; Slovak; Polish; Italian; Ukrainian
Selections vary depending on your country/area.
- Russian display is only available for the KX-T7730/KX-T7735RU.
- When "Russian" or "Ukrainian" is selected in this programme, during intercom calls, the calling extension's name assigned in Extension Name in Cyrillic [616] is displayed at the called extension. When another language is selected, the calling extension's name assigned in Extension Name [604] is displayed.

Extension Name in Cyrillic [616]

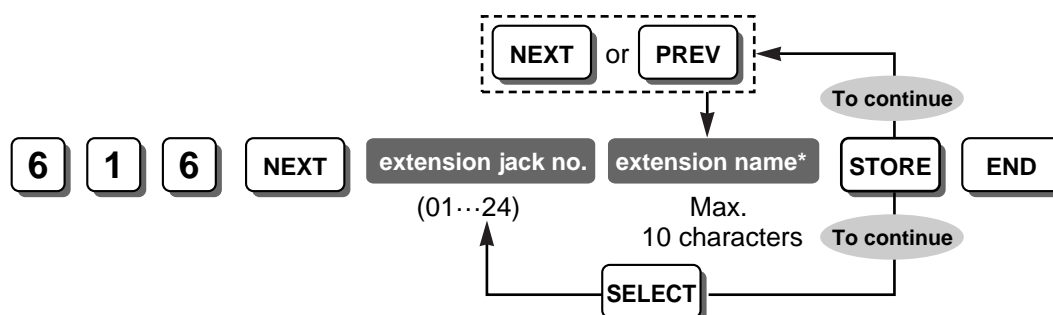

Notes

- * An extension name can be entered using a PT's dialling buttons. The displayed character varies depending on the number of times that the dialling button is pressed. It is possible to toggle between "Alphabet mode", "Cyrillic alphabet mode", and "Numeral mode" by pressing SELECT.
- Russian display is only available for the KX-T7730/KX-T7735RU.

Feature & Programming References

1.5.1.1 Intercom Call

3.3.1 Programming Instructions—Entering Characters

LCD Language [615]

Message Waiting for Another Extension [618]

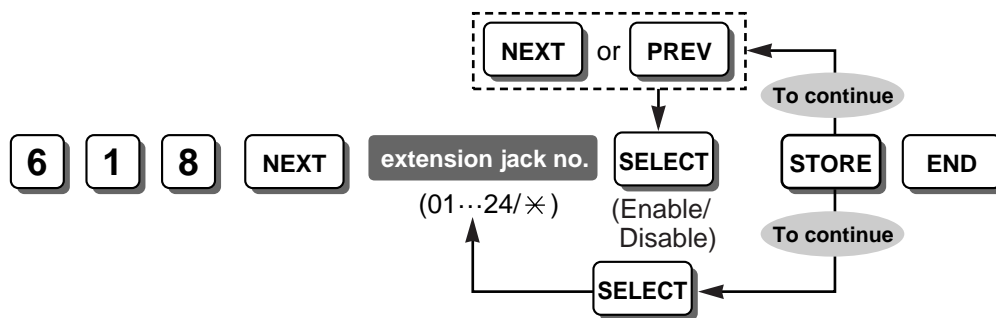

Feature & Programming References

1.17.1 Message Waiting

SLT Message Waiting [619]

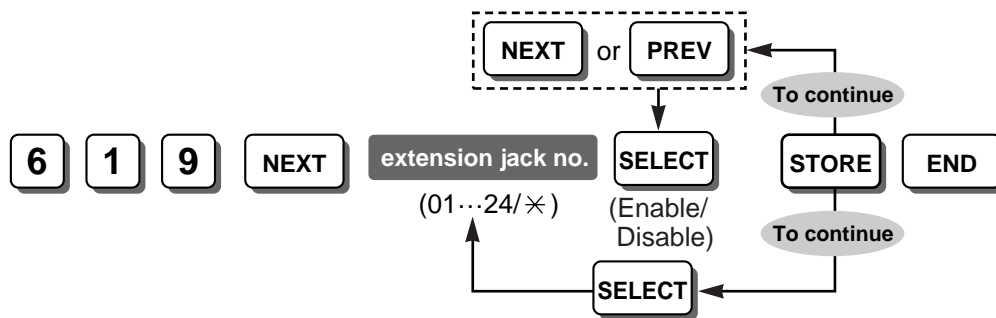

Feature & Programming References

1.17.1 Message Waiting

LCS Recording Mode Set [620]

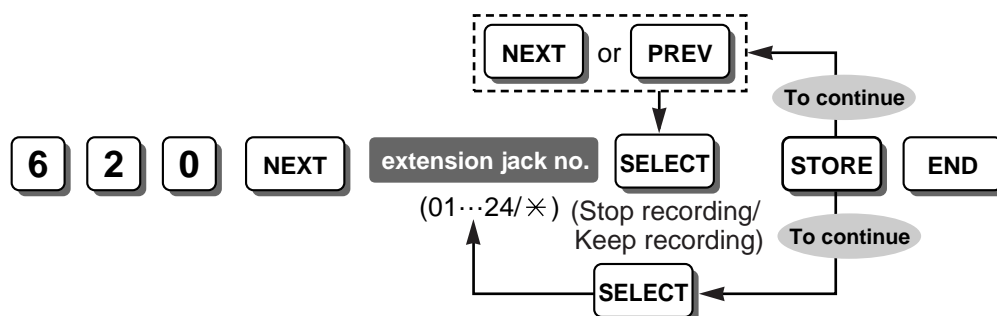

Feature & Programming References

1.19.1 Voice Mail APT Integration

BV Resource [621]

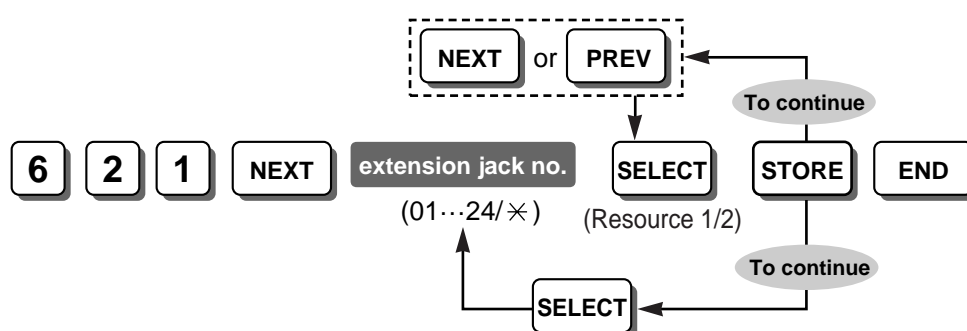

Feature & Programming References

1.15.7 Built-in Voice Message (BV)

BV for Extension [622]

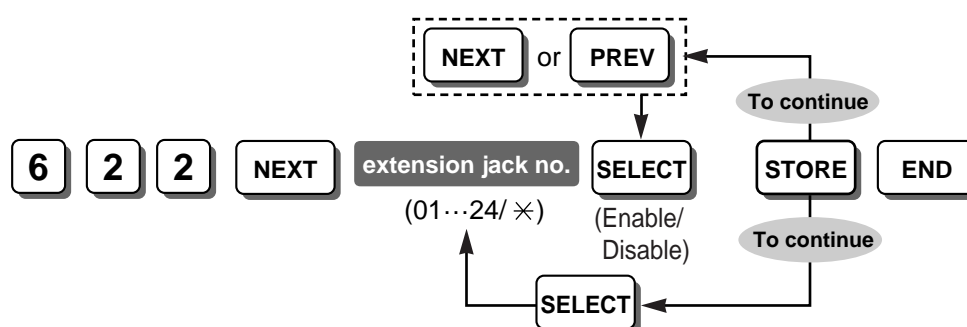

Feature & Programming References

1.15.7 Built-in Voice Message (BV)

BV Access Code through CO Line [625]

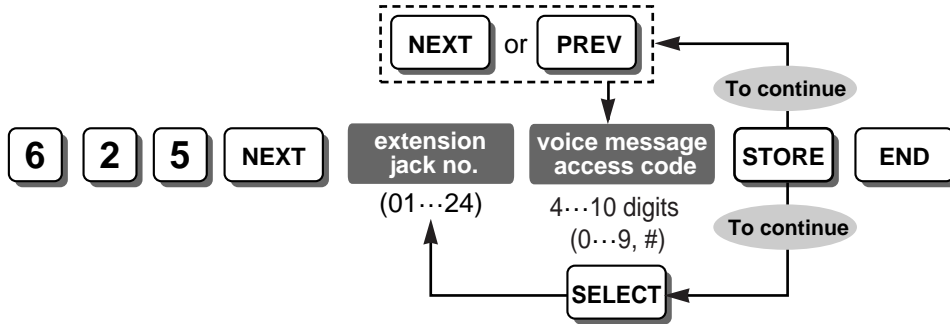

Notes

- A voice message access code should be different from the corresponding extension number. If the voice message access code is the same as an extension number, dialling that number will access the extension, not the voice message area.
- A code that starts with a number already assigned as another code cannot be used. For example, if you assign the codes "1234" and "12345", "12345" cannot be selected since "1234" will be recognised first.

Feature & Programming References

1.15.7 Built-in Voice Message (BV)

BGM Control for APT [626]

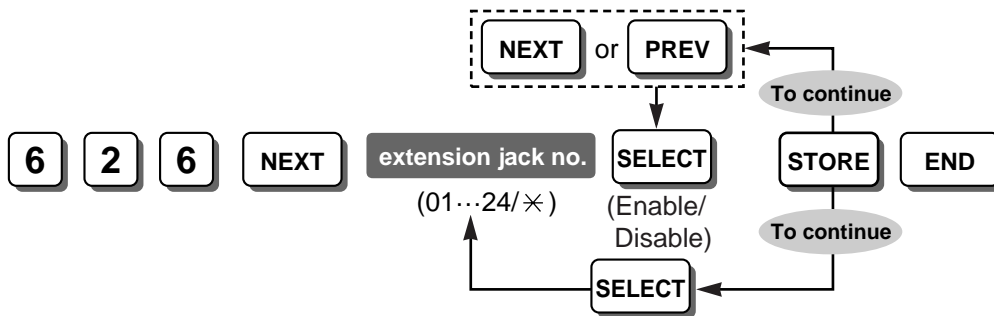

Feature & Programming References

1.15.4 Background Music (BGM)

SLT Ring Wait Time for New Call [627]

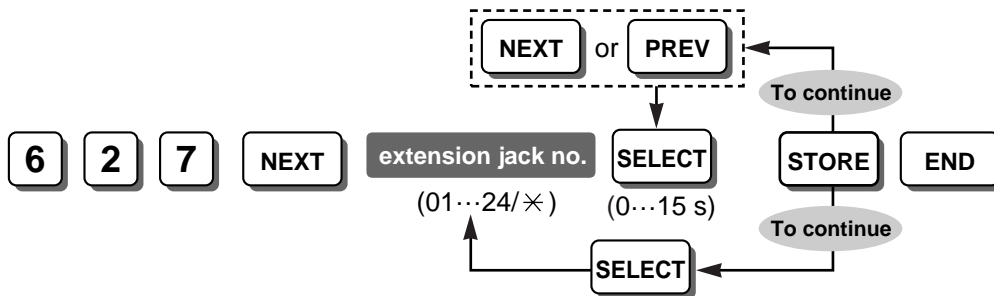

Feature & Programming References

1.16.1 Caller ID

SLT Caller ID [628]

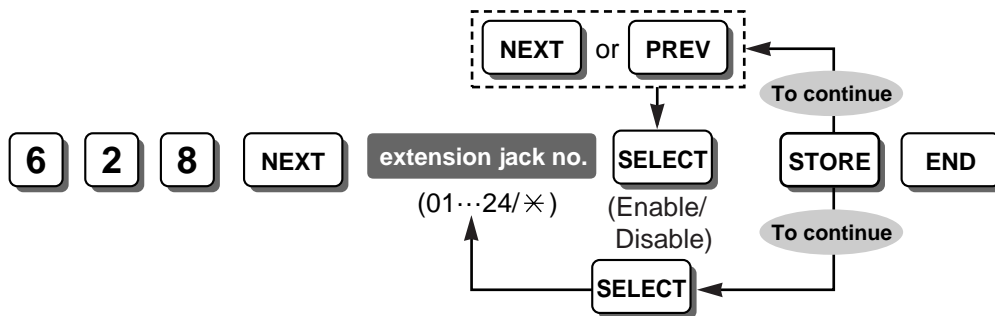

Feature & Programming References

1.16.1 Caller ID

SLT Fixed Bell Pattern [629]

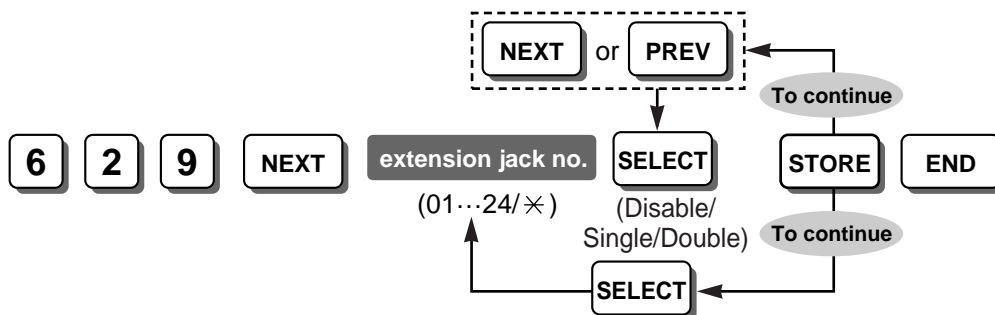

Feature & Programming References

1.1.3.3 Ring Tone Pattern Selection

1.16.1 Caller ID

LCD Display Mode [630]

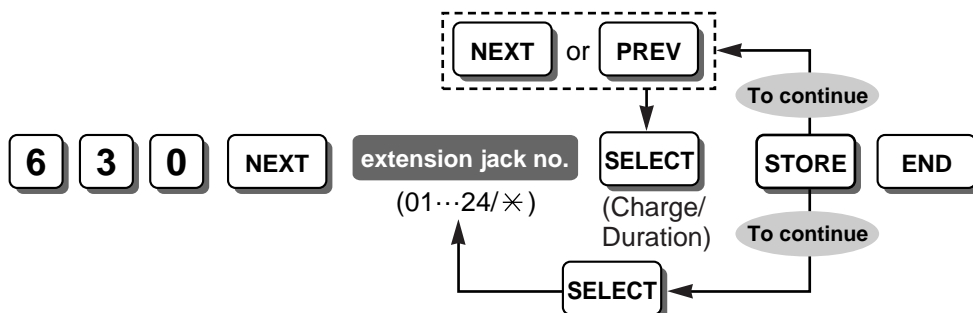

Feature & Programming References

1.20.2 Call Charge Calculation

Doorphone Ringing—Day/Night/Lunch [700-702]

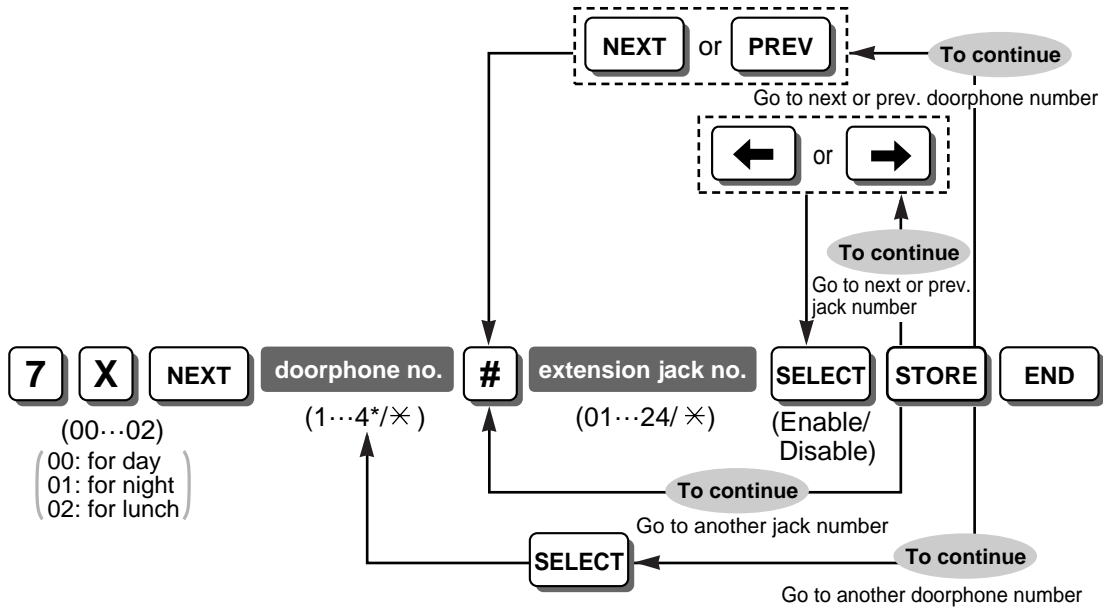

Note

* When using an optional 2-port doorphone card, select "1" and/or "3" (not "1" and/or "2") as the doorphone number.

Feature & Programming References

1.15.1 Doorphone Call

Door Opener—Day/Night/Lunch [703-705]

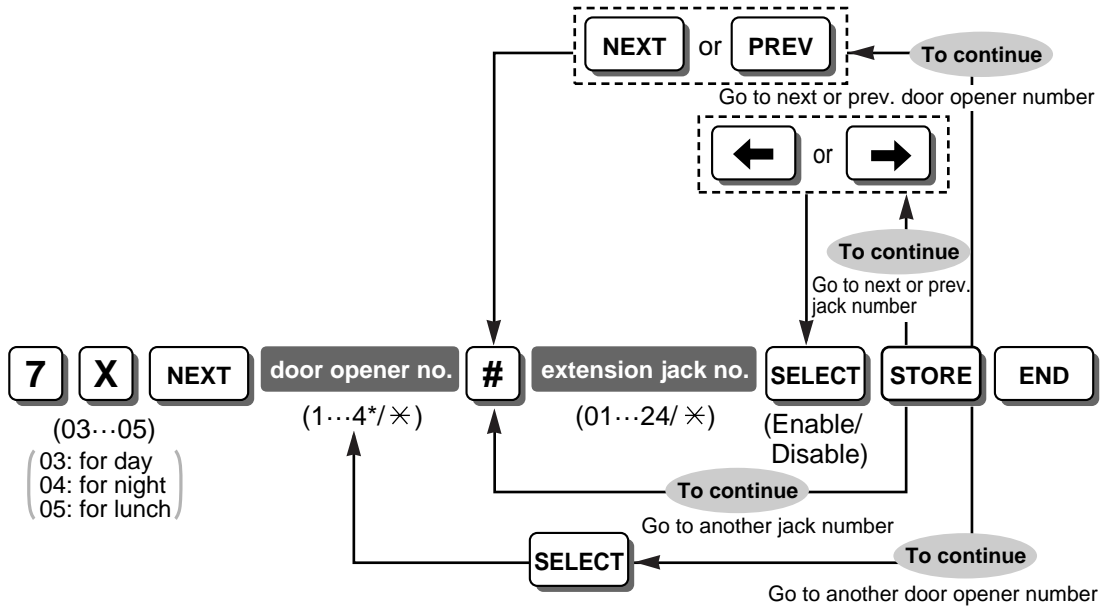

Note

* When using an optional 2-port doorphone card, select "1" and/or "3" (not "1" and/or "2") as the door opener number.

Feature & Programming References

1.15.2 Door Open

Doorphone Ring Tone Pattern [706]

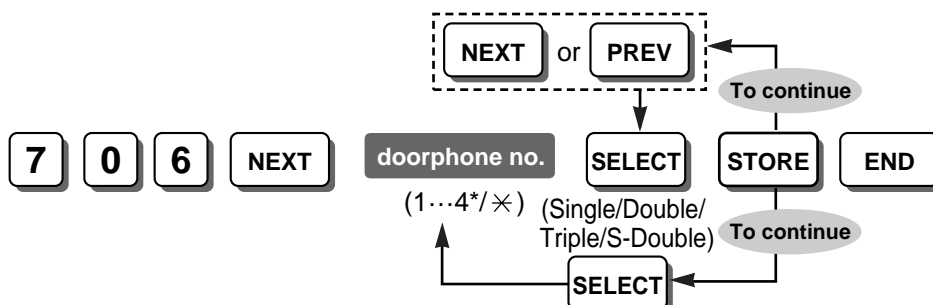

Notes

- * When using an optional 2-port doorphone card, select "1" and/or "3" (not "1" and/or "2") as the doorphone number.
- It is recommended that you set a different ring tone pattern from the ring tone patterns specified in Extension Ring Tone Pattern [115] and CO Line Ring Tone Pattern [423].

Feature & Programming References

1.1.3.3 Ring Tone Pattern Selection

1.15.1 Doorphone Call

Doorphone Access Tone [707]

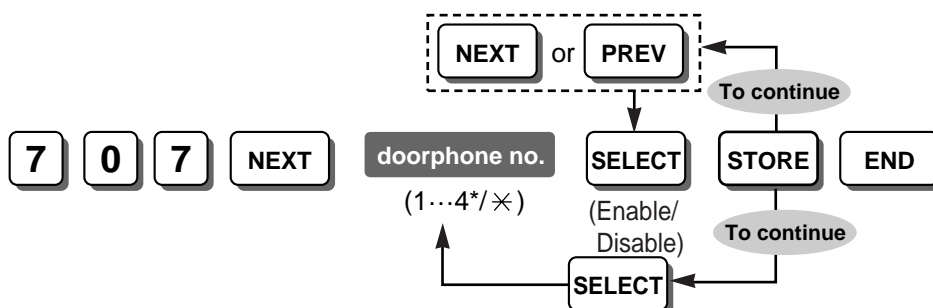

Note

- * When using an optional 2-port doorphone card, select "1" and/or "3" (not "1" and/or "2") as the doorphone number.

Feature & Programming References

1.10.2 Room Monitor

1.15.1 Doorphone Call

Doorphone Ring Time [708]

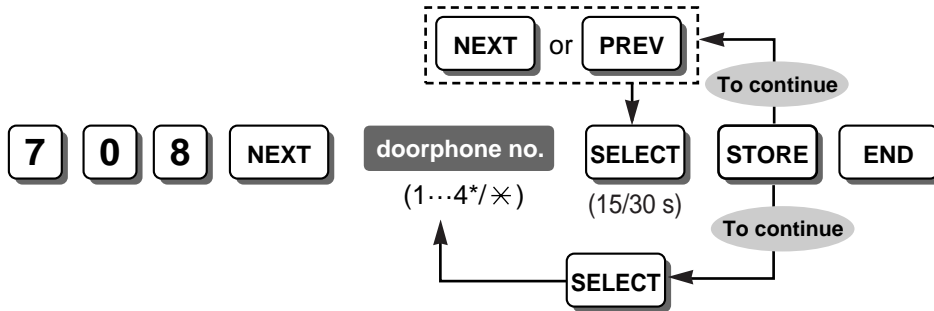

Note

* When using an optional 2-port doorphone card, select "1" and/or "3" (not "1" and/or "2") as the doorphone number.

Feature & Programming References

1.15.1 Doorphone Call

Door Open Duration [709]

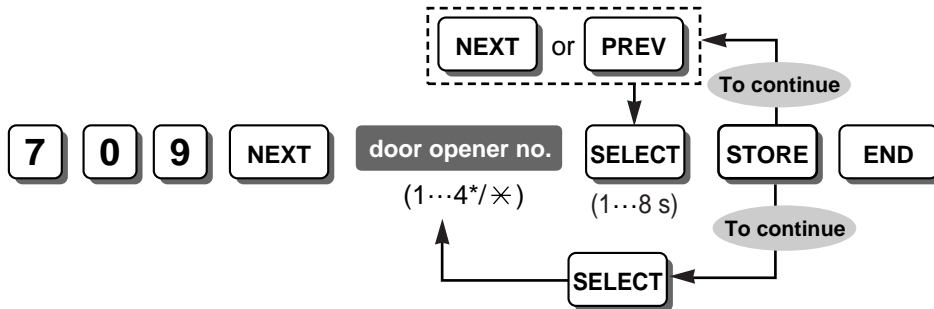

Note

* When using an optional 2-port doorphone card, select "1" and/or "3" (not "1" and/or "2") as the door opener number.

Feature & Programming References

1.15.2 Door Open

Doorphone Ring/Chime [710]

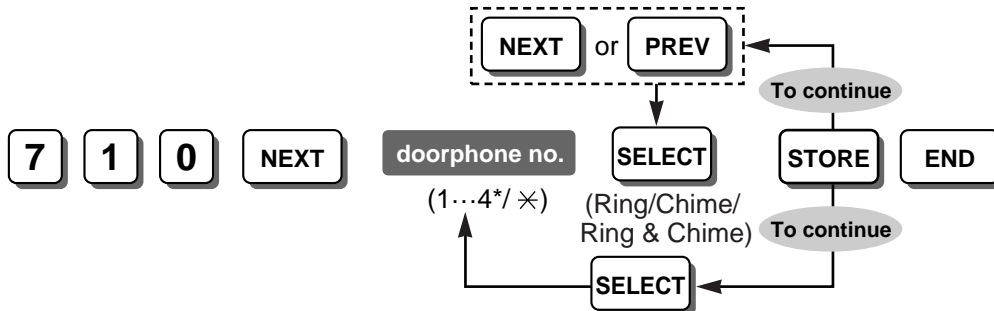

Note

* When using an optional 2-port doorphone card, select "1" and/or "3" (not "1" and/or "2") as the doorphone number.

Feature & Programming References

1.15.3 Doorbell/Door Chime

Doorphone Ringing—Day/Night/Lunch [700-702]

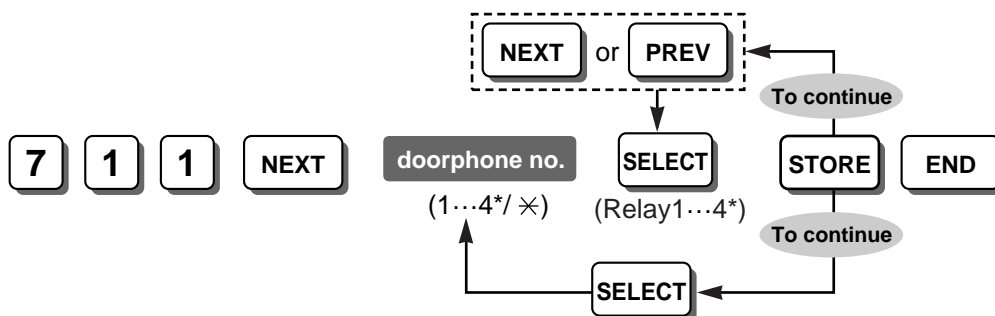
Doorphone Chime Assignment [711]**Note**

* When using an optional 2-port doorphone card, select "1" and/or "3" (not "1" and/or "2") as the doorphone and relay numbers.

Feature & Programming References

1.15.3 Doorbell/Door Chime

Doorphone Ring/Chime [710]

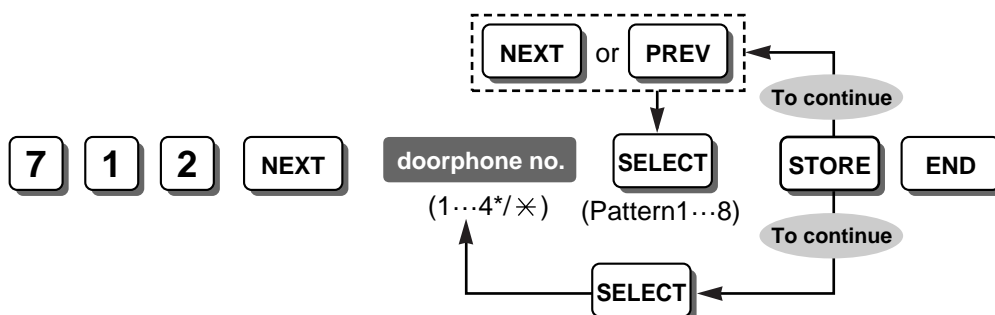
Doorphone Chime Pattern [712]**Note**

* When using an optional 2-port doorphone card, select "1" and/or "3" (not "1" and/or "2") as the doorphone number.

Feature & Programming References

1.15.3 Doorbell/Door Chime

4.2.1 Tones/Ring Tones

SMDR RS-232C Parameter [800]

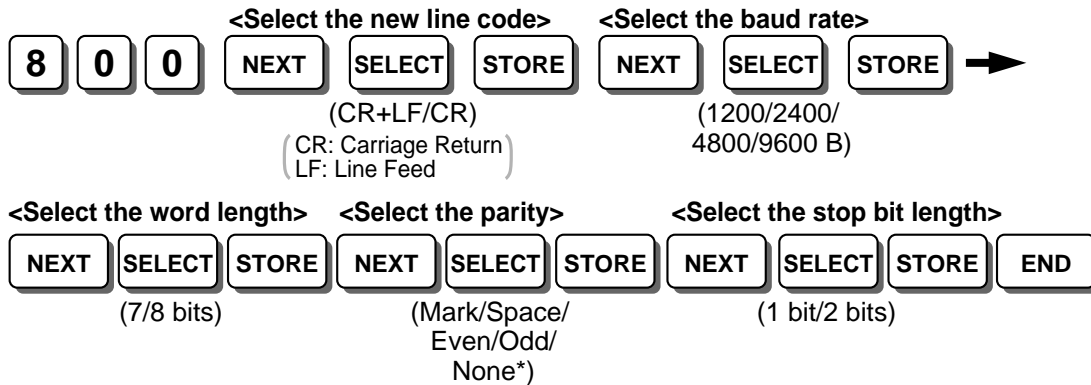

Notes

- * Select "None" when the printer does not require error checking.
- The following combinations are invalid.

Parity	Word length	Stop bit length
Mark	8	2
Space	8	1
Space	8	2

If any of the above invalid combinations are selected, an alarm tone will be heard.

Feature & Programming References

1.20.1 Station Message Detail Recording Feature

SMDR Parameter [801]

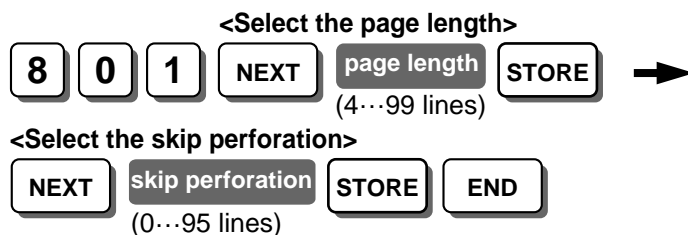

Note

To enable the changes, you must turn the power switch of the PBX off and back on again after changing this setting.

Feature & Programming References

1.20.1 Station Message Detail Recording Feature

Incoming/Outgoing Call Selection for Printing [802]



Note

Outgoing Call: On (Print all calls)/Off (No printing)/Toll (Print toll calls only)

Incoming Call: On (Print all calls)/Off (No printing)

Feature & Programming References

1.20.1 Station Message Detail Recording Feature

TRS—COS 2-5 Denied Code [302-305]

Secret Number SMDR Print Suppression [803]

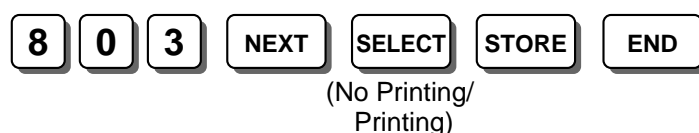

Feature & Programming References

1.20.1 Station Message Detail Recording Feature

System Speed Dialling Number [001]

System Data Dump [804]

<To select All parameters, System parameter, Speed dial, and/or Stop output>

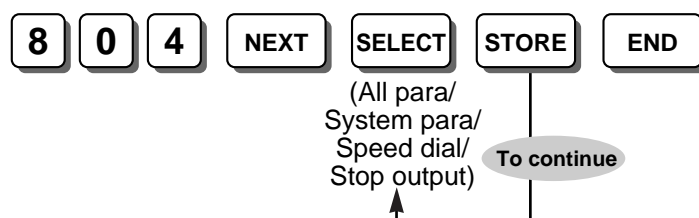

<To select the CO (outside line) parameter>



<To select the Extension parameter>



<To select the DSS parameter>



Feature & Programming References

1.20.1 Station Message Detail Recording Feature

SMDR Account Code [805]

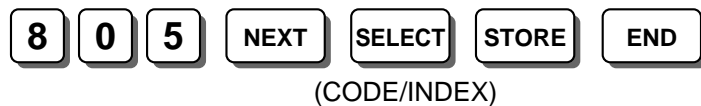

Feature & Programming References

1.8.2 Toll Restriction (TRS) Override by Account Code

1.20.1 Station Message Detail Recording Feature

Account Code [310]

Account Code Mode [605]

SMDR Language [806]



Note

* The following languages are available for SMDR:
English; Spanish; Portuguese; Greek; Czech; Hungarian; Slovak; Polish; Italian
Selections vary depending on your country/area.

Feature & Programming References

1.20.1 Station Message Detail Recording Feature

BV Total Recording Time [807]

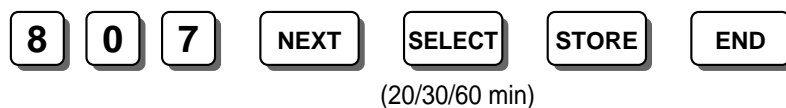

Note

The recording quality depends on the setting time.
20 (min): High; 30: Normal; 60: Low

Feature & Programming References

1.15.7 Built-in Voice Message (BV)

1.18.4 Display Information

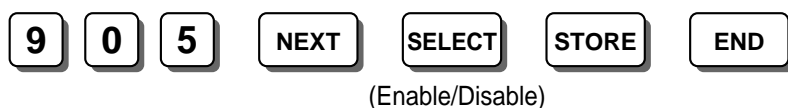
Caller ID Automatic 0 Addition [905]**Feature & Programming References**

1.16.1 Caller ID

Caller ID SMDR Format [906]**Note**

Even if a name is also sent by the Caller ID service, only the number is printed.

Feature & Programming References

1.20.1 Station Message Detail Recording Feature

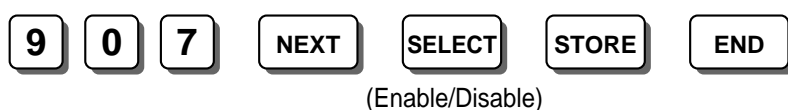
Caller ID SMDR Printout [907]**Note**

This programme enables a caller's telephone number to be shown by SMDR before the call is answered.

Feature & Programming References

1.20.1 Station Message Detail Recording Feature

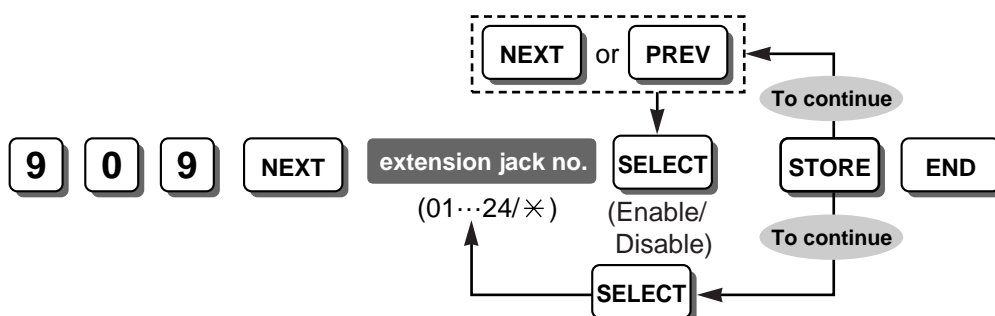
Common Area Call Log Check [909]**Feature & Programming References**

1.16.2 Incoming Call Log

Caller ID Type [910]

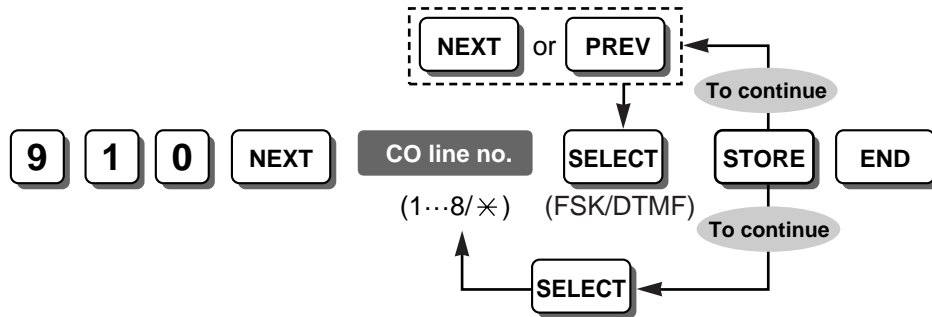

Feature & Programming References

1.16.1 Caller ID

Currency [921]



Note

* Currency can be entered using a PT's dialling buttons. The displayed character varies depending on the number of times that the dialling button is pressed. It is possible to toggle between "Alphabet mode" and "Numeral mode" by pressing SELECT.

Feature & Programming References

1.20.2 Call Charge Calculation

3.3.1 Programming Instructions—Entering Characters

Call Charge Information SMDR Format 1 [922]



Feature & Programming References

1.20.1 Station Message Detail Recording Feature

1.20.2 Call Charge Calculation

Call Charge Information SMDR Format 2 [923]



Note

MODE 1: Does not print out zeros (e.g., 2.86).

MODE 2: Prints out zeros (e.g., 00002.86).

Feature & Programming References

1.20.1 Station Message Detail Recording Feature

1.20.2 Call Charge Calculation

Secret Printing [924]

(No Secret/Secret)

Feature & Programming References

1.20.1.2 Call Log Printout for Each Extension

1.20.2 Call Charge Calculation

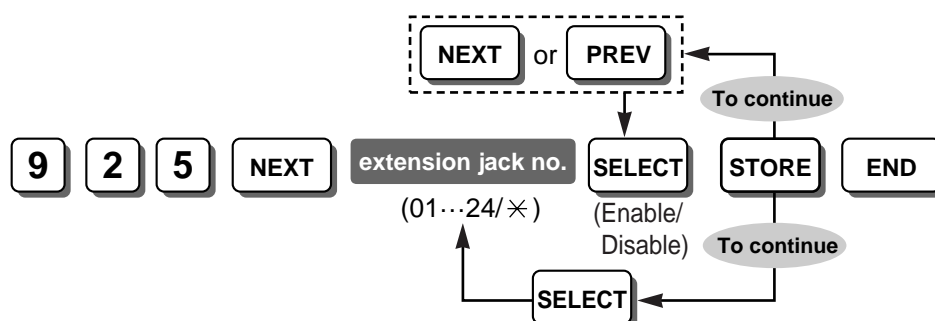
Budget Management [925]**Feature & Programming References**

1.8.3 Budget Management

1.20.2 Call Charge Calculation

Budget Limit Selection [926]

(Enable/Disable)

Note

Enable: Disconnect the call after the beeps.

Disable: From the next call.

Feature & Programming References

1.8.3 Budget Management

1.20.2 Call Charge Calculation

Call Log Next Page [927]

(Enable/Disable)

Note

This programme specifies whether or not a page break is inserted after each extension's call log printout.

SMDR Mode for Printing [929]

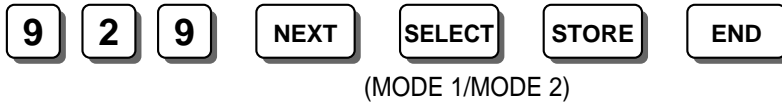

Note

Even if "On" (outgoing/incoming call) or "Toll" (outgoing call) is selected in Incoming/Outgoing Call Selection for Printing [802], when "MODE 2" is selected in this programme, the call log information is not displayed by SMDR, but the information for each extension is displayed by Call Log Printout.

Feature & Programming References

- 1.20.1.1 Station Message Detail Recording (SMDR)
- 1.20.1.2 Call Log Printout for Each Extension

Call Forwarding Selection [963]

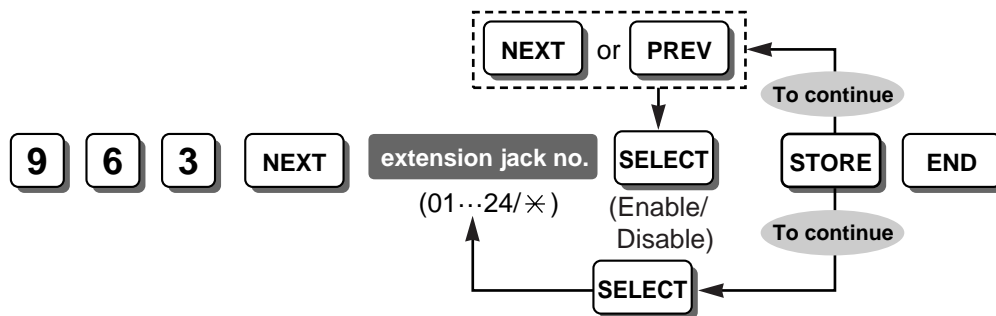

Note

This programme also functions for outside (CO) line calls via the DISA Intercept Routing feature, and when DISA calls are received by a DISA ring group.

Feature & Programming References

- 1.3.1.2 Call Forwarding (FWD)
- CO Line Mode—Day/Night/Lunch [414-416]

TRS Check after Answering [966]

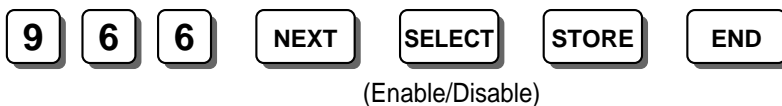

Note

This programme specifies whether the PBX checks DTMF signals when answering calls or not.

TRS Check Time after Answering [967]

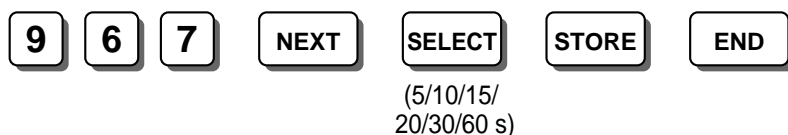

Note

This programme specifies the length of time that the DTMF signal is checked when "Enable" is selected in TRS Check after Answering [966].

KX-T7700 Series Incoming Lamp Control [968]

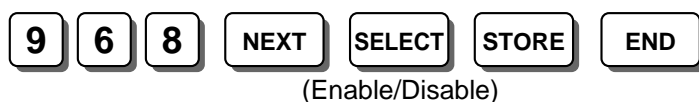

Feature & Programming References

1.17.1 Message Waiting

Country [995]

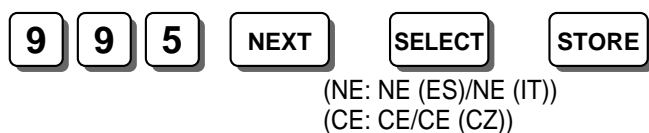

Notes

- This programme specifies your country/area when the suffix of the PBX is "NE" or "CE". For more information, please consult your dealer.
- When the country code is changed, all system data is initialised.

Feature & Programming References

2.3.6 Country Setting

Firmware Version [998]

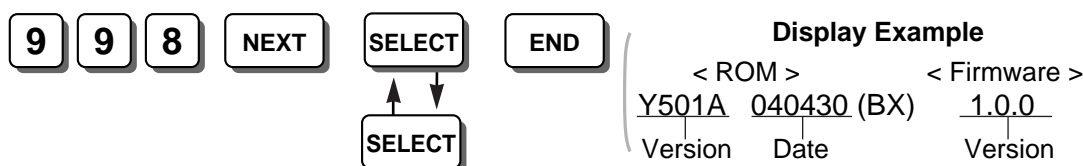

Note

You can confirm the ROM and the firmware version of the PBX alternately by pressing SELECT.

Feature & Programming References

2.3.7 Firmware Upgrade

System Data Clear [999]

<To select All parameters, System parameter, and/or Speed dial>

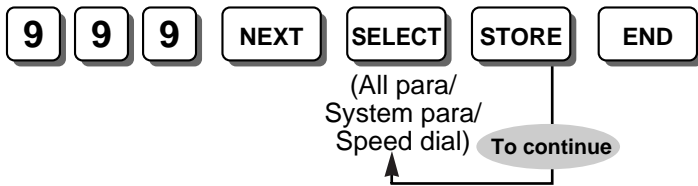

<To select the CO (outside line) parameter>



<To select the Extension parameter>



<To select the DSS parameter>



Feature & Programming References

2.3.2 PT Programming

Section 4

Appendix

4.1 Capacity of System Resources

4.1.1 Capacity of System Resources

Category	Item	KX-TES824/KX-TEM824
System	Outside (CO) Line Group	8
	Extension Group	8
	Absent Message	6 × 16 characters
	Message Waiting	8/extn.
	Number of Characters of Name	10
	Extension Number Digits	2 or 3
	Call Park Zone	10
	Conference (5-party)	1
	Account Code	4 digits, 50 entries
	Host PBX Access Code	1 or 2 digits, 8 entries
	Station Message Detail Recording (SMDR)	64 calls (10 000 calls with optional message expansion card)
	Call Log Printout for Each Extension	500 calls (10 000 calls with optional message expansion card)
	Intercom Call	4
Outgoing Message (OGM) for DISA/UCD	32 resources/PBX (8 resources for Direct Inward System Access [DISA]/Uniform Call Distribution [UCD], 24 resources for 3-level Automated Attendant [AA])	
Dialling	Emergency Call	24 digits, 5 entries
	Quick Dialling	10 digits, 10 entries
	System Speed Dialling	32 digits, 100 entries
	Personal Speed Dialling	24 digits, 10 entries/extn.
	One-touch Dialling	24 digits
	Hot Line	32 digits
	Redial	64 digits
Automatic Route Selection (ARS)	Leading Number Table	7 digits, 80 entries
	Leading Number Exception Table	7 digits, 80 entries
	ARS Carrier	4

Category	Item	KX-TES824/KX-TEM824
Toll Restriction (TRS)	Class of Service (COS)	5
	Denied Code Table	11 digits, 80 entries
	Exception Code Table	11 digits, 80 entries
Call Log	Incoming Call Log	20 entries/extn., 300 entries/PBX
		125 voice messages/Built-in Voice Message (BV) resource
Password	System Password	4–7 digits
	Extension Password	4 digits
	Voice Message Access Code	4–10 digits

4.2 Tones/Ring Tones

4.2.1 Tones/Ring Tones

Tone Patterns

Dial Tone 1

Normal

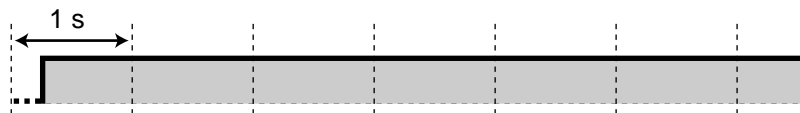

[Brazil only]



Dial Tone 2

Any of the following features is set:

- Absent Message
- Background Music (BGM) (proprietary telephone [PT] only)
- Call Forwarding (FWD)
- Call Pickup Deny
- Data Line Security
- Do Not Disturb (DND)
- Extension Lock
- Hot Line (single line telephone [SLT] only)
- Message Waiting (PT only)
- Remote Extension Lock
- Timed Reminder

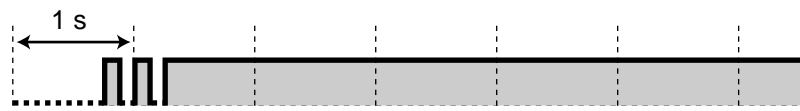

[Brazil only]

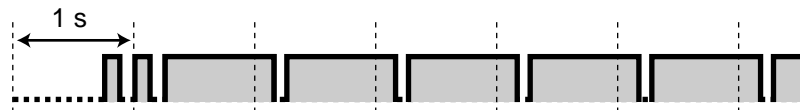

[Czech Republic only]

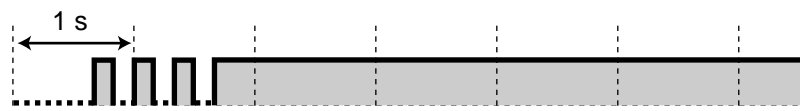

Dial Tone 3

- When going off-hook with an SLT that has messages waiting
- When Account Code Entry is performed
- When answering a call from Timed Reminder



Dial Tone 4

A new voice message has been recorded (Built-in Voice Message [BV]).

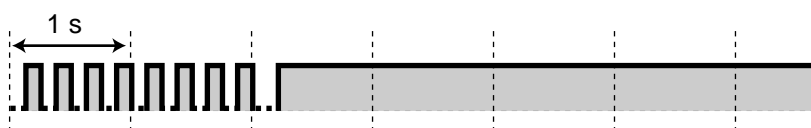
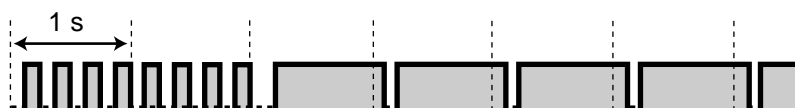
**[Brazil only]****Dial Tone 5**

The remaining voice message recording time is less than 5 minutes or 125 voice messages have been recorded (Built-in Voice Message [BV]).

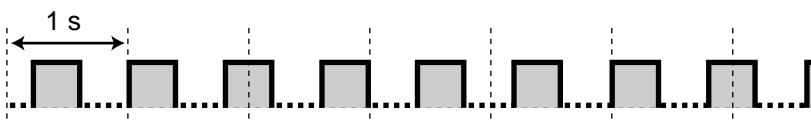
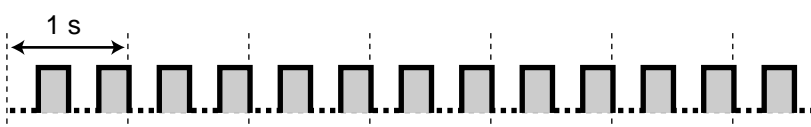
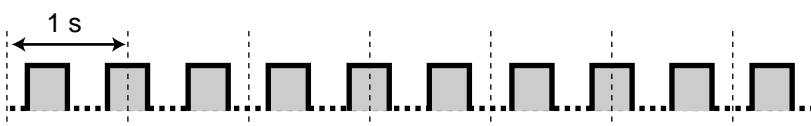
**[Brazil only]****Busy Tones****[Australia/New Zealand only]****[Brazil only]****[Czech Republic only]**

Reorder Tones

The outside (CO) line you tried to seize is not assigned or was denied.



[Brazil only]

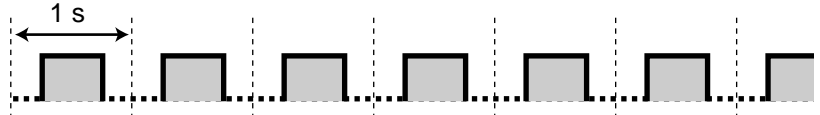

[Czech Republic only]



[Malaysia only]

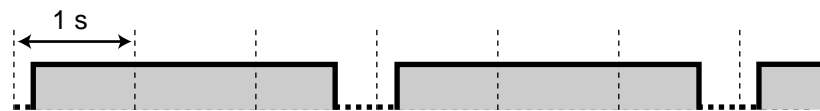

Ringback Tones

Single (3-s interval)

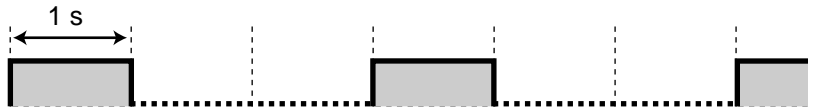

Double (3-s interval)

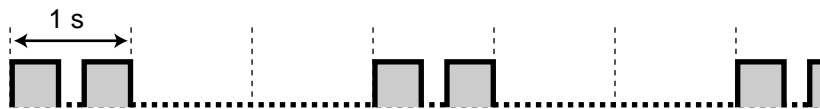

Single (5-s interval)



Double (5-s interval)



DND Tone

The dialled extension is refusing incoming calls.

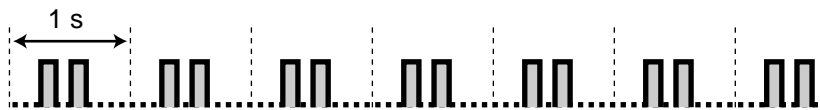

Call Waiting Tone 1

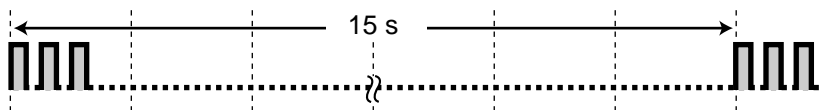

Call Waiting Tone 2

Single



Double



Triple

**Hold Alarm Tone**

A call has been on hold for longer than the specified time.

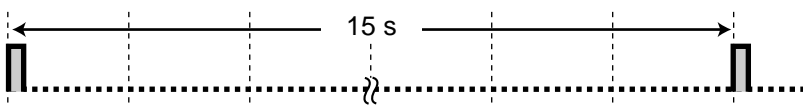
**Warning Tone (Outside (CO) Line Call Limitation)**

This tone is sent 15 seconds before the specified time for disconnection.

**Confirmation Tone 1**

The feature was set successfully, or the Extension Lock feature was set or cancelled.

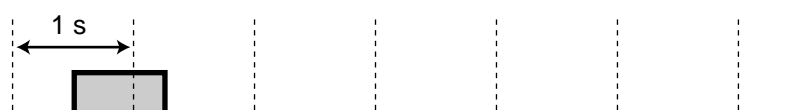
**Confirmation Tone 2**

The new feature setting was the same as the previous setting, or certain features were successfully performed or accessed (e.g., Call Hold, Automatic Callback Busy).

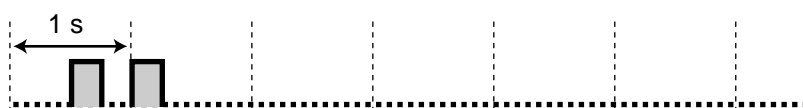
**Confirmation Tone 3**

Before the following features activate:

- Retrieving a held call
- Picking up another call
- Establishing a conference call
- Paging/Answering a paging announcement



Ring Tone Patterns

Ring Tone Patterns

The following ring tone patterns can be assigned to incoming call types (outside (CO) line, intercom, or doorphone calls), or are fixed for certain features (Hold Recall [outside (CO) line calls/intercom calls], Timed Reminder, or Camp-on Recall).

Single

- Selectable: outside (CO) line calls, intercom calls, doorphone calls
- Fixed: Hold Recall [outside (CO) line calls]

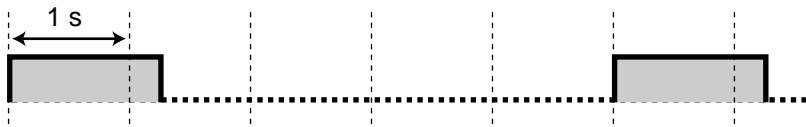

Double

- Selectable: outside (CO) line calls, intercom calls, doorphone calls
- Fixed: Hold Recall [intercom calls]



Triple

- Selectable: outside (CO) line calls, intercom calls, doorphone calls
- Fixed: Timed Reminder



S-Double

- Selectable: doorphone calls
- Fixed: Camp-on Recall

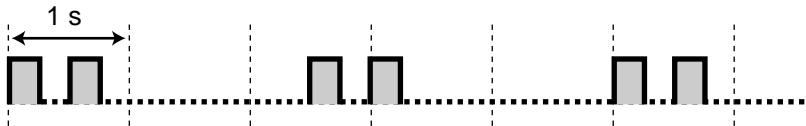

Ring Tone Patterns Sent from the Telephone Company (New Zealand only)

The following ring tone patterns sent from the telephone company can be detected for each outside (CO) line.

Pattern 1

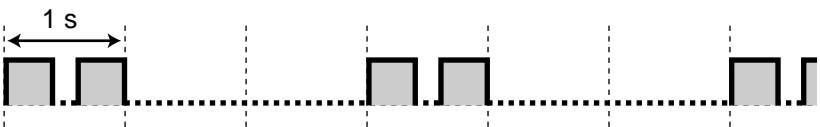

Pattern 2

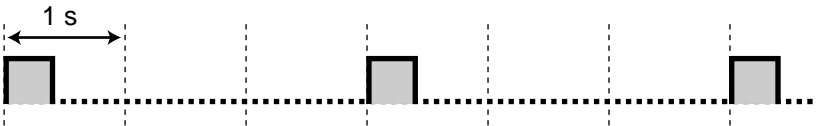

Pattern 3

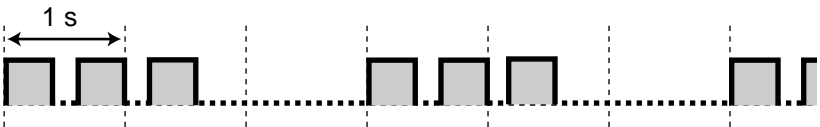

Pattern 4

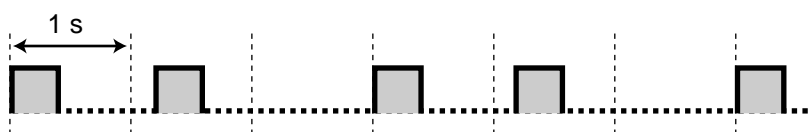

Doorphone Chime Patterns

The following doorphone chime patterns can be assigned to each doorphone when doorbells and door chimes are connected to the PBX.

Pattern 1*



Pattern 2*



Pattern 3*



Pattern 4*

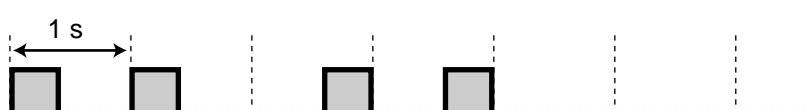

Pattern 5



Pattern 6



Pattern 7



Pattern 8

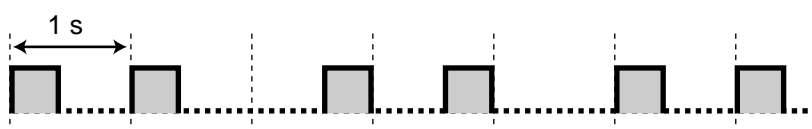

* Chime patterns 1 to 4 are played only one time during the doorphone ringing time.

4.3 Revision History

4.3.1 Version 2.0

New Contents

- 1.5.2.6 CO Busy Out
- 1.8.3 Budget Management
- 1.20.2 Call Charge Calculation
- 3.3.2 Programming Procedures
 - CO Busy Out [154]
 - CO Busy Out Check Time [155]
 - Call Charge Calculation—Registering Leading Numbers [161]
 - Call Charge Calculation—Time Table 1/2/3/4 [162/169/176/183]
 - Call Charge Table 1/2/3/4—Peak Flat Charge and Duration [163/170/177/184]
 - Call Charge Table 1/2/3/4—Peak Unit Charge and Duration [164/171/178/185]
 - Call Charge Table 1/2/3/4—Off Peak Flat Charge and Duration [165/172/179/186]
 - Call Charge Table 1/2/3/4—Off Peak Unit Charge and Duration [166/173/180/187]
 - Call Charge Table 1/2/3/4—Economy Flat Charge and Duration [167/174/181/188]
 - Call Charge Table 1/2/3/4—Economy Unit Charge and Duration [168/175/182/189]
 - Decimal Places [190]
 - Call Charge Calculation [441]
 - Call Charge Table Assignment [442]
 - LCD Display Mode [630]
 - Currency [921]
 - Call Charge Information SMDR Format 1 [922]
 - Call Charge Information SMDR Format 2 [923]
 - Secret Printing [924]
 - Budget Management [925]
 - Budget Limit Selection [926]

Changed Contents

- 1.5.2.2 Emergency Call
- 1.10.8 Outside (CO) Line Call Limitation
- 1.18.4 Display Information
- 1.20.1 Station Message Detail Recording Feature
 - 1.20.1.1 Station Message Detail Recording (SMDR)

1.20.1.2 Call Log Printout for Each Extension

- 2.2.4 Operator/Manager Features
- 2.3.2 PT Programming
- 3.3.1 Programming Instructions
- 4.1.1 Capacity of System Resources
- 4.2.1 Tones/Ring Tones

4.3 Revision History

Index

Numerics

- 1st Carrier Selection Code [359] 233
- 2-way Recording into the VPS 147
- 3-level AA Assignment [540-549] 254
- 3-level Automated Attendant (AA) 107
- 3-party Conference 99
- 5-party Conference 99

A

- Absent Message 130
- Account Code [310] 231
- Account Code Entry 43
- Account Code Mode [605] 256
- Administrative Information Features 152
- Alternate Calling—Ring/Voice 39
- Alternate Receiving—Ring/Voice 39
- Answering Features 35
- Answering Features—OVERVIEW 35
- Appendix 279
- ARS CO Line Group [364] 234
- ARS Dial Tone [362] 233
- ARS Inter-digit Time [363] 234
- ARS Modification—Added Number [361] 233
- ARS Modification—Removed Digits [360] 233
- ARS Selection [350] 232
- ARS → Automatic Route Selection (ARS) 74
- Audible Tone Features 169
- Authorisation and Itemised Billing Code Order [390] 235
- Authorisation Code 77
- Automatic Callback Busy (Camp-on) 62
- Automatic Configuration for Outside (CO) Line Type 193
- Automatic Designated Line Access [419] 242
- Automatic Line Access (Local Access) 52
- Automatic Line Access [121] 218
- Automatic Pause Insertion Code [311] 231
- Automatic Redial 58
- Automatic Redial Interval [114] 217
- Automatic Redial Repeat Count [113] 216
- Automatic Rotation for CO Line Access [122] 218
- Automatic Route Selection (ARS) 74
- Automatic Route Selection (ARS) Features 74
- Automatic Time Adjustment 186
- Automatic Time Adjustment [152] 222

B

- Background Music (BGM) 106
- Bell Frequency [120] 218
- Bell-off Detection [213] 229
- BGM Control for APT [626] 262
- BGM → Background Music (BGM) 106
- Break Ratio [123] 219
- Budget Limit Selection [926] 275
- Budget Management 71, 87
- Budget Management [925] 275
- Built-in Voice Message (BV) 116
- Busy Line/Busy Party Features 62
- Busy Tones 283
- Buttons and Functions 202
- BV Access Code through CO Line [625] 262

- BV Card Initialisation [808] 271
- BV for Extension [622] 261
- BV Recording Time [214] 229
- BV Resource [621] 261
- BV Total Recording Time [807] 270
- BV → Built-in Voice Message (BV) 116

C

- Call Charge Calculation 161
- Call Charge Calculation [441] 246
- Call Charge Calculation—Registering Leading Numbers [161] 223
- Call Charge Calculation—Time Table 1/2/3/4 [162/169/176/183] 224
- Call Charge Information SMDR Format 1 [922] 274
- Call Charge Information SMDR Format 2 [923] 274
- Call Charge Table 1/2/3/4—Economy Flat Charge and Duration [167/174/181/188] 226
- Call Charge Table 1/2/3/4—Economy Unit Charge and Duration [168/175/182/189] 226
- Call Charge Table 1/2/3/4—Off Peak Flat Charge and Duration [165/172/179/186] 225
- Call Charge Table 1/2/3/4—Off Peak Unit Charge and Duration [166/173/180/187] 225
- Call Charge Table 1/2/3/4—Peak Flat Charge and Duration [163/170/177/184] 224
- Call Charge Table 1/2/3/4—Peak Unit Charge and Duration [164/171/178/185] 225
- Call Charge Table Assignment [442] 247
- Call Duration Counter Start [204] 227
- Call Forwarding (FWD) 31
- Call Forwarding (FWD)/Do Not Disturb (DND) 30
- Call Forwarding (FWD)/Do Not Disturb (DND) Features 30
- Call Forwarding (FWD)/Do Not Disturb (DND)—OVERVIEW 30
- Call Forwarding Selection [963] 276
- Call Forwarding Start Time [202] 227
- Call Forwarding to CO Line [607] 256
- Call Handling Features 13
- Call Hold 92
- Call Log Next Page [927] 275
- Call Log Printout for Each Extension 159
- Call Park 94
- Call Park Recall 94
- Call Pickup 37
- Call Pickup Deny 37
- Call Pickup Tone [117] 217
- Call Retrieving from a Telephone Answering Machine (TAM) 37
- Call Splitting 95
- Call Transfer 90
- Call Transfer to CO Line [606] 256
- Call Transfer with Announcement 90
- Call Transfer without Announcement 90
- Call Transfer—Screened → Call Transfer with Announcement 90
- Call Transfer—Unscreened → Call Transfer without Announcement 90
- Call Waiting 22
- Call Waiting Tone 64
- Caller ID 121
- Caller ID [900] 271
- Caller ID Area Code [901] 271
- Caller ID Automatic 0 Addition [905] 273
- Caller ID Display on SLT 121

Caller ID Features	121
Caller ID Log Priority [904]	272
Caller ID Modification for Local Calls [902]	272
Caller ID Modification for Long-distance Calls [903]	272
Caller ID SMDR Format [906]	273
Caller ID SMDR Printout [907]	273
Caller ID Type [910]	274
Calling Party Control (CPC) Signal Detection	89
Capacity of System Resources	280
Carrier Exception Code [300]	230
Circular Hunting	23
Class of Service (COS)	173
Clear All OGMs of DISA/UCD [599]	254
CO Busy Out	46
CO Busy Out [154]	223
CO Busy Out Check Time [155]	223
CO Indicator [109]	215
CO Line Call Duration Limitation [613]	258
CO Line Connection [400]	236
CO Line Group Number [404]	238
CO Line Mode—Day/Night/Lunch [414-416]	240
CO Line Ring Tone Pattern [423]	243
Collect Call Block [425] (Brazil only)	244
Common Area Call Log Check [909]	273
Common BV OGM	116
Common/Personal BV OGM Recording Time [215]	229
Conference	99
Conference Features	98
Conference Features—OVERVIEW	98
Conference Pattern [116]	217
Conference Tone [105]	214
Confirmation Tone	170
Console Paired Telephone [004]	209
Consultation Hold	97
Conversation Features	80
COS → Class of Service (COS)	173
CO-to-CO Line Call Duration [205]	227
Country [995]	277
Country Setting	194
CPC Signal Detection—Incoming [420]	242
CPC Signal Detection—Outgoing [421]	242
CPC → Calling Party Control (CPC) Signal Detection	89
Currency [921]	274
Cyclic Tone Detection [513]	250
D	
Data Line Security	84
Date & Time [000]	207
Decimal Places [190]	226
Delayed Ringing	28
Delayed Ringing—Day/Night/Lunch [411-413]	239
Denied Code Tables	65
Dial Mode [401]	236
Dial Tone	169
Dial Type Selection	44
Dialling Start Time [206]	228
DIL → Direct In Line (DIL)	14
Direct In Line (DIL)	14
Direct Inward System Access (DISA)	108
Direct Inward System Access (DISA) Ring	28
Direct Message feature	119
Direct One-touch Answering	35
Direct Outside (CO) Line Access	52
Directed Call Pickup	37
DISA AA Service	108
DISA AA Wait Time [517]	251
DISA Built-in AA [501]	247
DISA Busy Mode [506]	248
DISA Delayed Answer Time [504]	248
DISA Incoming Assignment [516]	251
DISA Incoming Call Dial Mode [500]	247
DISA Intercept Mode [507]	248
DISA IRNA to BV—Day/Night/Lunch [438-440]	246
DISA No Dial Mode [510]	249
DISA Ring Time after Intercept [509]	249
DISA Ring Time before Intercept [508]	249
DISA Ringback Tone [531]	254
DISA Security Code [512]	250
DISA Security Code Digits [530]	253
DISA Security Mode [511]	249
DISA Tone after Security Code [518]	251
DISA Wait Time after OGM [505]	248
DISA → Direct Inward System Access (DISA)	28, 108
Disconnect Time [422]	243
Display Information	141
Distinctive Ring Detection (DRD) [426] (New Zealand only)	244
Distinctive Ring Detection (DRD) for New Zealand	20
DND Override	34
DND Override [609]	257
DND Tone	284
DND → Call Forwarding (FWD)/Do Not Disturb (DND)	30
Do Not Disturb (DND)	34
Door Open	103
Door Open Duration [709]	266
Door Opener—Day/Night/Lunch [703-705]	264
Doorbell/Door Chime	104
Doorphone Access Tone [707]	265
Doorphone Call	102
Doorphone Chime Assignment [711]	267
Doorphone Chime Pattern [712]	267
Doorphone Chime Patterns	287
Doorphone Ring Time [708]	266
Doorphone Ring Tone Pattern [706]	265
Doorphone Ring/Chime [710]	266
Doorphone Ringing—Day/Night/Lunch [700-702]	264
DRD Pattern 2 and 3 Ring Tone [433-434] (New Zealand only)	246
DRD Ring Pattern 2 Extension Assignment—Day/Night/Lunch [427-429] (New Zealand only)	245
DRD Ring Pattern 3 Extension Assignment—Day/Night/Lunch [430-432] (New Zealand only)	245
DRD → Distinctive Ring Detection (DRD) for New Zealand	20
DSS Console Jack Assignment [003]	209
DSS Lamp Mode [112]	216
DSS Off-hook Mode [126]	219
DTMF Integration [103]	214
DTMF Integration Port [102]	214
DTMF Receiver Check [107]	215
DTMF Time [210]	228

Index

- E**
- EFA → External Feature Access (EFA) 86
 - Electronic Station Lockout → Extension Lock 72
 - Emergency Call 42
 - Emergency Number [309] 231
 - Entering Characters 204
 - Entering Manager Programming Mode 203
 - Entering System Programming Mode 203
 - Exception Code Tables 65
 - Exclusive Call Hold 92
 - Executive Busy Override 63
 - Executive Busy Override [608] 257
 - Executive Busy Override Deny 63
 - Extension Controlling Features 167
 - Extension Feature Clear 167
 - Extension Group [600] 255
 - Extension Jack Configuration 172
 - Extension Lock 72
 - Extension Lock—CANCEL ALL 72
 - Extension Name [604] 255
 - Extension Name in Cyrillic [616] 259
 - Extension Number [009] 211
 - Extension Ring Tone Pattern [115] 217
 - Extension-to-CO Line Call Duration [212] 229
 - Extension-to-Outside (CO) Line Call Duration 87
 - External Feature Access (EFA) 86
 - External Pager Access Tone [106] 215
- F**
- Fault Recovery/Diagnostics 196
 - FAX Connection [503] 248
 - FAX Tone Detection [514] 251
 - Feature Guide References 2
 - Feature Highlights 5
 - Feature Numbering 187
 - Firmware Upgrade 195
 - Firmware Version [998] 277
 - Fixed Buttons 135
 - Fixed Line SMS Terminal Support 131
 - Flash/Recall 85
 - Flash/Recall Key Mode [110] 216
 - Flash/Recall Mode for a Locked Extension [108] 215
 - Flash/Recall Time [418] 241
 - Flexible Buttons 137
 - Flexible Outward Dialling—Day/Night/Lunch [405-407] 238
 - Flexible Ringing—Day/Night/Lunch [408-410] 239
 - FWD to Outside (CO) Line 31
 - FWD → Call Forwarding (FWD)/Do Not Disturb (DND) 30
 - FWD—All Calls 31
 - FWD—Busy/No Answer 31
 - FWD—Follow Me 31
- G**
- General Call Hold 92
 - Group 174
 - Group Call Pickup 37
- H**
- Handset/Headset Selection → Headset Operation 83
 - Hands-free Answerback 38
 - Hands-free Operation 80
 - Headset Operation 83
 - Hold Recall 92
 - Hold Recall Time [200] 226
 - Holding Features 92
 - Hookswitch Flash Timing Range [207] 228
 - Host PBX Access Code (Access Code to the Telephone Company from a Host PBX) 48
 - Host PBX Access Code [403] 237
 - Hot Line 61
 - Hot Line Waiting Time [203] 227
 - Hunting Group Set [100] 213
 - Hunting Type [101] 213
- I**
- Idle Extension Hunting 23
 - Idle Line Preference 51
 - Incoming Call Features 14
 - Incoming Call Indication Features 17
 - Incoming Call Indication Features—OVERVIEW 17
 - Incoming Call Log 125
 - Incoming Call Log Display Lock 126
 - Incoming Outside (CO) Line Call Features 14
 - Incoming Reverse [153] 223
 - Incoming/Outgoing Call Selection for Printing [802] 269
 - Installation Manual References 2
 - Installing and Starting KX-TE Maintenance Console 201
 - Intercept Routing 15
 - Intercept Routing—No Answer (IRNA) 15
 - Intercept Routing—No Dial 15
 - Intercept Time for Internal DISA [515] 251
 - Intercom Call 39
 - Intercom Call Features 39
 - Inter-digit Time [208] 228
 - Internal Call Features 16
 - Internal Pulse Detection [614] 259
 - Introduction 200
 - IRNA → Intercept Routing—No Answer (IRNA) 15
 - Itemised Billing Code 77
 - Itemised Billing Code [389] 235
- K**
- KX-T7700 Series Incoming Lamp Control [968] 277
 - KX-T7710 One-touch Dialling 57
 - KX-T7710 One-touch Dialling [013] 213
- L**
- Last Number Redial 58
 - LCD Display Mode [630] 263
 - LCD Language [615] 259
 - LCD Time Display [010] 211
 - LCS Recording Mode Set [620] 261
 - LED Indication 139
 - Line Preference Override 51
 - Line Preference—Incoming 36

Line Preference—Outgoing 51
 Live Call Screening (LCS) 146
 Lockout 87
 Log-in/Log-out 29

M

Making Call Features 39
 Memory Dialling Features 54
 Memory Dialling Features—OVERVIEW 54
 Message Features 128
 Message Waiting 128
 Message Waiting for Another Extension [618] 260
 Message Waiting for Another Extension Lock 128
 Microphone Mute 82
 Music on Hold 96
 Music on Hold [111] 216

N

No Dial Disconnection [211] 229
 No Line Preference 36, 51

O

OGM Mute Time [519] 252
 One-touch Dialling 56
 One-touch Transfer 90
 One-touch Transfer Using a DSS Button [005] 209
 Operator Assignment [008] 210
 Operator Call 180
 Operator/Manager Features 179
 Optional Device Features 102
 Outgoing Message (OGM) for DISA/UCD 107
 Outside (CO) Line Access 52
 Outside (CO) Line Call Features 41
 Outside (CO) Line Call Features—OVERVIEW 41
 Outside (CO) Line Call Limitation 87
 Outside (CO) Line Group Access 52
 Outside (CO) Line Ringing Selection 18
 Outside-to-Outside (CO-to-CO) Line Call Duration 87

P

Paging 101
 Paging Deny 101
 Paging Features 101
 Paging—All Extensions 101
 Paging—All Extensions & External 101
 Paging—External 101
 Paging—Group 101
 Paralleled Telephone 88
 Paralleled Telephone [610] 257
 Password Security 200
 Pause Insertion 47
 Pause Time [417] 241
 PC Programming 182, 201
 Personal BV OGM 116
 Pickup Dialling → Hot Line 61
 Pickup Group [127] 219
 Polarity Reverse Detection [424] 244
 Polarity Reverse Detection → Reverse Circuit 45

Power Failure Connections 196
 Power Failure Restart 197
 Power Failure Transfer 196
 Prime Line Preference 36, 51
 Programming Instructions 199, 202
 Programming Procedures 207
 Proprietary Telephone (PT) Features 135
 PT Programming 184, 202
 PT Programming References 2
 PT → Proprietary Telephone (PT) Features 135
 Pulse Restriction [118] 218
 Pulse Speed [402] 237
 Pulse to Tone Conversion 44

Q

Quick Dialling 60

R

Receiving Calls 35
 Receiving Group Features 23
 Redial 58
 Redialling after Pulse to Tone Conversion [119] 218
 Remote Extension Lock 72
 Remote Station Lock Control → Remote Extension Lock 72
 Remote Timed Reminder 168
 Reorder Tones 284
 Required Telephone 202
 Reverse Circuit 45
 Revision History 288
 Ring Tone Pattern Selection 19
 Ring Tone Patterns 286
 Ring Tone Patterns Sent from the Telephone Company (New Zealand only) 286
 Ringback Tone Pattern [128] 220
 Ringback Tones 284
 Ringing Line Preference 36
 Room Monitor 81
 Room Monitor [612] 258
 Route 1-4 Authorisation Code [381-384] 234
 Route 1-4 Exception Code [355-358] 232
 Route 1-4 Itemised Billing [385-388] 235
 Route 1-4 Selection Code [351-354] 232

S

Saved Number Redial 58
 S-CO Line Access 52
 Second Feature Numbering Plan [012] 212
 Secret Dialling 55
 Secret Number SMDR Print Suppression [803] 269
 Secret Printing [924] 275
 Seizing a Line Features 50
 Seizing a Line Features—OVERVIEW 50
 SLT Caller ID [628] 263
 SLT Caller ID Line Access Number [151] 222
 SLT Caller ID Signalling Type [150] 222
 SLT Fixed Bell Pattern [629] 263
 SLT Hold Mode [104] 214
 SLT Message Waiting [619] 260
 SLT Ring Bell-on Time [143] 221

Index

SLT Ring Wait Time for New Call [627] 262
SLT Ring/Silence Ratio [142] 221
SMDR Account Code [805] 270
SMDR Language [806] 270
SMDR Mode for Printing [929] 276
SMDR Parameter [801] 268
SMDR RS-232C Parameter [800] 268
SMDR → Station Message Detail Recording (SMDR) 152
SMS Centre Number for Receiving [145] 221
SMS Routing Table—CO [146] 221
SMS Routing Table—Extension [147] 222
SMS → Short Message Service (SMS) 131
Speed Dialling—Personal/System 59
Station Feature Clear → Extension Feature Clear 167
Station Hunting → Idle Extension Hunting 23
Station Message Detail Recording (SMDR) 152
Station Message Detail Recording Feature 152
Station Programme Clear → Extension Feature Clear 167
Station Speed Dialling → Personal Speed Dialling 59
System Configuration and Administration Features 171
System Configuration—Hardware 172
System Configuration—Software 173
System Data Clear [999] 278
System Data Control 182
System Data Dump [804] 269
System Password [002] 208
System Requirements 201
System Speed Dialling Name [011] 212
System Speed Dialling Number [001] 207

T

TAM Extension [611] 258
TAM → Call Retrieving from a Telephone Answering Machine (TAM) 37
Terminated Hunting 23
Time Service 176
Time Service Start Time [007] 210
Time Service Switching Mode [006] 210
Timed Reminder 168
Toll Restriction (TRS) 65
Toll Restriction (TRS) Features 65
Toll Restriction (TRS) Override by Account Code 69
Tones/Ring Tones 282
Transfer Recall 90
Transfer Recall Time [201] 227
Transferring Features 90
TRS Check after Answering [966] 276
TRS Check for * and # [125] 219
TRS Check Time after Answering [967] 277
TRS for System Speed Dialling 66
TRS → Toll Restriction (TRS) Features 65
TRS-COS—Day/Night/Lunch [601-603] 255
TRS—COS 2-5 Denied Code [302-305] 230
TRS—Exception Code [306] 230
TRS—Extension Lock Class 68, 72
TRS—Extension Lock Class [312] 232
TRS—System Speed Dialling Class [301] 230

U

UCD Busy Mode [523] 252

UCD Busy Waiting Time [521] 252
UCD Group [520] 252
UCD Intercept Mode [524] 253
UCD OGM Message Interval Time [522] 252
UCD Ring Time after Intercept [526] 253
UCD Ring Time before Intercept [525] 253
UCD Waiting Message [527] 253
Unattended Conference 99
Unattended Conference Recall 99
Uniform Call Distribution (UCD) 25
User Manual References 2

V

Version 2.0 288
VM 1 APT Port [130] 220
VM 2 APT Port [131] 220
VM → Voice Mail Features 143
Voice Mail APT Integration 143
Voice Mail Features 143
Voice Mail Inband (DTMF) Integration 149

W

Walking COS 73
Warning Tone (Outside (CO) Line Call Limitation) 285

Panasonic Communications Co., Ltd.

1-62, 4-chome, Minoshima, Hakata-ku, Fukuoka 812-8531, Japan



Copyright:

This material is copyrighted by Panasonic Communications Co., Ltd., and may be reproduced for internal use only. All other reproduction, in whole or in part, is prohibited without the written consent of Panasonic Communications Co., Ltd.

© 2004 Panasonic Communications Co., Ltd. All Rights Reserved.